

Surgical Manual

Tapered & Parallel Walled Implants

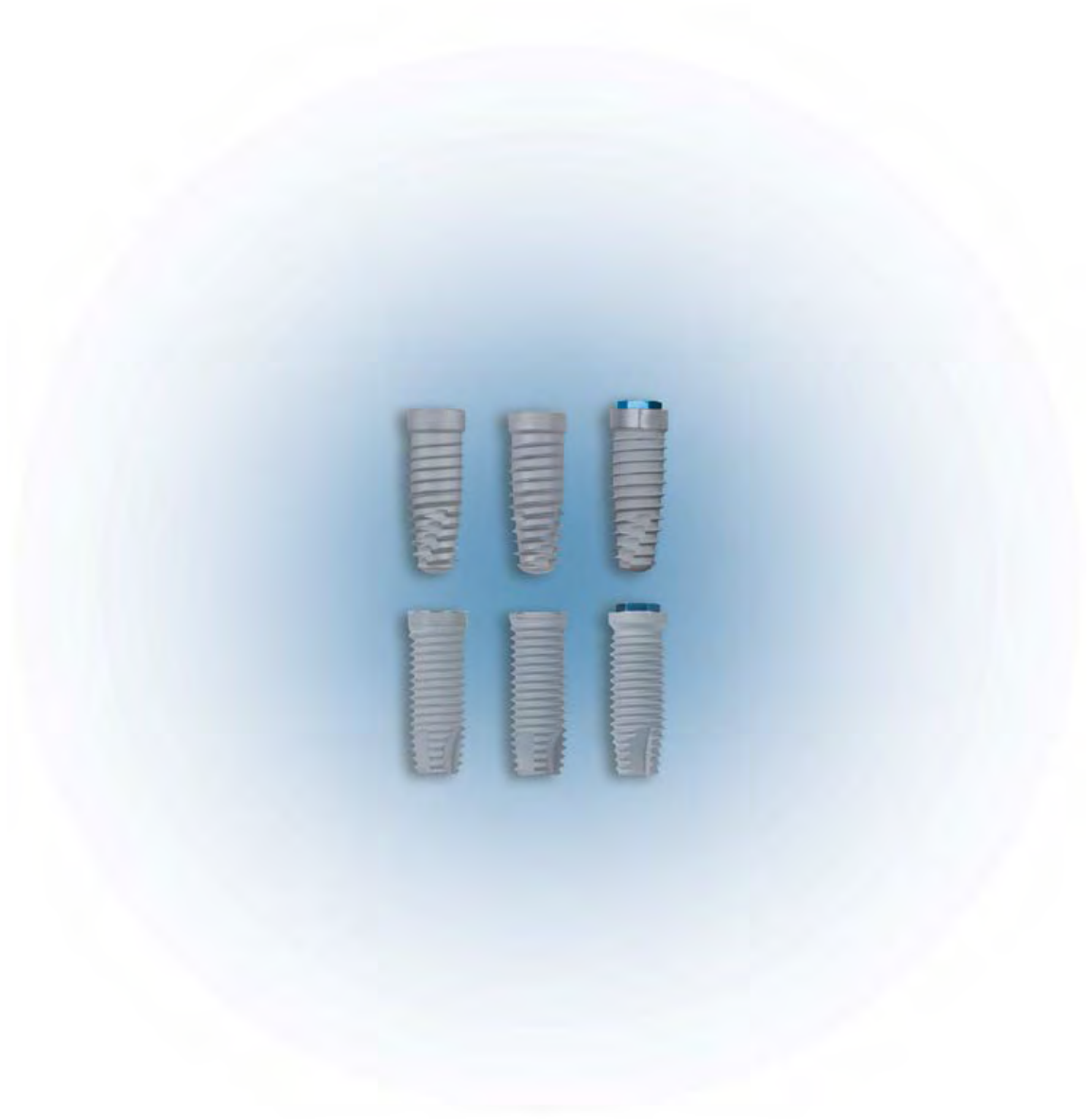

Important Product Information

For BIOMET 3i Dental Implants

Instructions For Use:

For a detailed explanation of the osteotomy preparation and implant placement guidelines, please refer to the appropriate Surgical Manual(s).

Description:

BIOMET 3i Dental Implants are manufactured from biocompatible titanium or titanium alloy. BIOMET 3i Dental Implants include various surface treatments. For specific product descriptions, please refer to individual product labels.

Indications For Use:

BIOMET 3i Dental Implants are intended for surgical placement in the upper or lower jaw to provide a means for prosthetic attachment in single tooth restorations and in partially or fully edentulous spans with multiple single teeth utilizing delayed loading, or as a terminal or intermediary abutment for fixed or removable bridgework, and to retain overdentures. BIOMET 3i T3®, NanoTite™ and OSSEOTITE® Dental Implants may also utilize immediate loading for these indications.

BIOMET 3i T3, NanoTite and OSSEOTITE Dental Implants are intended for immediate function on single tooth and/or multiple tooth applications when good primary stability is achieved, with appropriate occlusal loading, in order to restore chewing function.

Contraindications:

Placement of dental implants may be precluded by both patient conditions that are contraindications for surgery as well as hypersensitivity to commercially pure titanium or titanium alloy (including vanadium, aluminum and calcium phosphate).

BIOMET 3i Dental Implants should not be placed in patients where the remaining jaw bone is too diminished to provide adequate implant stability.

Warnings:

Excessive bone loss or breakage of a dental implant may occur when an implant is loaded beyond its functional capability. Physiological and anatomical conditions may affect the performance of dental implants.

Mishandling of small components inside the patient's mouth carries a risk of aspiration and/or swallowing.

Forcing the implant into the osteotomy deeper than the depth established by the drills can result in damage to the implant, driver or osteotomy.

For short implants, clinicians should closely monitor patients for any of the following conditions: peri-implant bone loss, changes to the implant's response to percussion or radiographic changes in bone to implant contact along the implant's length. If the implant shows mobility or greater than 50% bone loss, the implant should be evaluated for possible removal. If a clinician chooses a short implant, then the clinician should consider a two-stage surgical approach, splinting a short implant to an additional implant and placement of the widest possible fixture. In addition, the clinician should allow longer periods for osseointegration and avoid immediate loading.

Reuse of BIOMET 3i Products that are labeled for single-use may result in product contamination, patient infection and/or failure of the device to perform as intended.

MRI Statement:

BIOMET 3i Dental Implants have not been evaluated for safety, heating, migration, or compatibility in the Magnetic Resonance Imaging (MRI) environment.

Precautions:

These devices are only to be used by trained professionals. The surgical and restorative techniques required to properly utilize these devices are highly specialized and complex procedures. Improper technique can lead to implant failure, loss of supporting bone, restoration fracture, screw loosening and aspiration. When the clinician has determined adequate primary stability is achieved, immediate functional loading can be considered.

The following should be taken into consideration when placing dental implants: bone quality, oral hygiene and medical conditions such as blood disorders or uncontrolled hormonal conditions. The healing period varies depending on the quality of the bone at the implantation site, the tissue response to the implanted device and the surgeon's evaluation of the patient's bone density at the time of the surgical procedure. Proper occlusion should be evaluated on the implant restoration to avoid excessive force during the healing period on the implant.

It is recommended that implants less than 4mm diameter **NOT** be placed in the posterior regions.

Sterility:

All dental implants are supplied sterile and are labeled "STERILE". All products sold sterile are for single-use before the expiration date printed on the product label. Do not use sterile products if the packaging has been damaged or previously opened. Do not re-sterilize.

Storage And Handling:

Devices should be stored at room temperature. Refer to individual product labels and the Surgical Manual for special storage or handling conditions.

Potential Adverse Events:

Potential adverse events associated with the use of dental implants may include: failure to integrate, loss of integration, dehiscence requiring bone grafting, perforation of the maxillary sinus, inferior border, lingual plate, labial plate, inferior alveolar canal or gingiva, infection as reported by abscess, fistula, suppuration, inflammation, or radiolucency, persistent pain, numbness, paresthesia, hyperplasia, excessive bone loss requiring intervention, implant breakage or fracture, systemic infection, nerve injury and aspiration.

Caution:

U.S. Federal Law restricts this device to sale by or on the order of a licensed dentist or physician.

Table Of Contents

Introduction And Treatment Planning	1
Preoperative Planning	2
Top-Down Treatment Planning	3-4
Surgical Precautions	5
Cleaning And Sterilization	6
Bone Density	7

Tapered Implants

Why BIOMET 3i Tapered Implants Are Different	9
Quad Shaping Drills (QSDs)	10
Twist Drill Depth Marking System	11-14
Implant Depth/Direction Indicator (NTDI)	15
Implant Bone Taps And Bone Tap Kit (NTAPK)	16
Implant Surgical Tray (QNTSK)	17
Quick Reference Subcrestal Surgical Protocol	18-19
Subcrestal Surgical Protocol	
3.25mm(D) Implants	20
Platform Switched 4mm(D) x 3.4mm(P) & 4mm(D) Implants	23-25
Platform Switched 5mm(D) x 4.1mm(P) & 5mm(D) Implants	26-28
Platform Switched 6mm(D) x 5mm(P) & 6mm(D) Implants	29-32
Subcrestal Implant Placement Protocol	33-36



Parallel Walled Implants

Twist Drill Depth Marking System	39-43
Quick Reference Subcrestal Surgical Protocol	44-45
Subcrestal Surgical Protocol	
3.25mm(D) Implants	46-47
3.75mm(D) Implants	48-49
Platform Switched 4mm(D) x 3.4mm(P) & 4mm(D) Implants	50-51
Platform Switched 5mm(D) x 4.1mm(P) & 5mm(D) Implants	52-53
Platform Switched 6mm(D) x 5mm(P) & 6mm(D) Implants	54-56
Subcrestal Implant Placement Protocol	57-60

Tapered & Parallel Walled Implants

Surgical Indexing	61-62
Single Stage Treatment Protocol	63
Mountless Delivery Protocol	64
Implant Placement In Dense Bone - Tapered Implants	65
Implant Placement In Dense Bone - Tapered & Parallel Walled Implants	66
Bone Profiling - Tapered & Parallel Walled Implants	67

Icon Key:

Certain® Internal Connection Implant System:	
External Hex Connection Implant System:	
Certain Internal and External Hex Connection Implant Systems:	

How To Use The Icon Key:

The icons represent the connection types of the BIOMET **3i** Implant System for both internal and external connection types represented in this manual. In the fully illustrated protocols, each icon is present next to each step. When a solid blue icon and a light blue icon are present together, the solid blue indicates which system is illustrated. When both icons are solid blue, then both systems are illustrated together.

Introduction And Treatment Planning

These instructions were designed to serve as a reference guide for dental practitioners utilizing BIOMET 3i Implants and Surgical Instruments.

The design of BIOMET 3i Implants and Surgical Instruments enable the practitioner to place implants in edentulous or partially edentulous mandibles or maxillae in order to support fixed and removable bridgework, single tooth crowns and overdentures.

General Information:

The success of any dental implant system depends upon proper use of the components and instrumentation. This manual is not intended for use as a substitute for professional training and experience.

Treatment Planning:

Patient Evaluation And Selection

Several important factors must be considered when evaluating a patient prior to implant surgery. The presurgical evaluation must include a careful and detailed assessment of the patient's general health, current medical status, medical history, oral hygiene, motivation and expectations. Factors such as tobacco use, masticatory function and alcohol consumption should also be considered. In addition, the clinician should determine if the patient presents an acceptable anatomical basis conducive to implant placement. An extensive intraoral examination should be performed to evaluate the oral cavity for any potential bone or soft-tissue pathology. The examiner should also determine the periodontal status of the

remaining teeth, the health of the soft-tissue and the presence of occlusal abnormalities such as bruxism or crossbite. The presence of other conditions that could adversely affect any existing natural dentition or healthy soft-tissue surrounding the implant should also be evaluated.

Diseases of the mucous membrane and connective tissues, pathologic bone disease and severe malocclusion can affect the determination of whether a patient is a suitable implant candidate.

The use of anticoagulants and the existence of metabolic diseases, such as diabetes, allergies, chronic renal or cardiac disease and blood dyscrasia may significantly influence the patient's ability to successfully undergo implant procedures.

If the patient's medical history reveals an existing condition or signals a potential problem that may compromise treatment and/or the patient's well-being, consultation with a physician is recommended.

Preoperative Planning

Preoperative Planning:

Proper treatment planning, as well as the selection of the proper implant length and diameter, are crucial to the long-term success of the implant and restoration. Before an implant can be selected, the anatomical foundation available to receive the implant must be carefully assessed. Several steps should be taken to complete the evaluation:

1. Clinical examination of the oral cavity can provide important information about the health of the soft-tissue at the proposed implant site. Tissue tone and the state of the superficial tissues should be evaluated. In addition, the patient should demonstrate an adequate dimension of attached gingiva or keratinized tissue at the site selected for implantation. In partially edentulous cases, the periodontal status of the remaining dentition should be assessed and interaction between the implant restoration and the adjacent natural dentition should be considered.
2. The bony foundation and ridge need to be clinically analyzed to ensure the presence of proper dimensions and the amount of bone for implant placement. At least one millimeter of bone should be present at the buccal and lingual aspects of the implant following placement. During the planning stage, it is useful to measure the existing bone foundation.

NOTE: Please ensure as many implants as necessary are used for a fully stable restoration.

CT Scans:

Computed Tomography (CT) scans help surgeons view parts of the body with three-dimensional images. Image-guided surgical planning allows surgeons to see anatomical landmarks such as nerves, sinus cavities and bony structures in order to plan for the placement of dental implants and prostheses.

Through the use of CT scans, clinicians are able to more precisely measure the locations of anatomical structures, dimensions of the underlying bone and ascertain bone densities in order to plan and treat clinically demanding cases.

Radiographic Marking Balls (RMB30):

The vertical height of the bone can be determined radiographically. Accurate measurement of the vertical dimension on the radiograph facilitates the selection of the appropriate implant length. This helps to avoid implant placement into the maxillary sinus, the floor of the nose or the mandibular canal and prevents perforation of the inferior aspect of the mandible. Measurements can be made directly on the panoramic radiograph using a millimeter ruler. Corrections should be made for the degree of enlargement or reduction produced by the particular radiographic equipment.

Radiographic marking balls of a known dimension can be embedded in a plastic template prior to radiographic examination. Once the radiograph is taken and the metal marking balls are visible on the image, measurements can be taken to determine the amount of bone available for implant placement.

To calculate the distortion factor, a simple formula can be utilized: $(5 \div A) \times B =$ the amount of actual bone available.

Formula Key =

- Radiographic marking ball = 5mm in diameter.
- A = Size of marking ball image on radiograph.
- B = Length in millimeters on the radiograph of available bone between the crest of the ridge and the inferior alveolar canal.

Example:

A = 6.5mm

B = 14mm

Therefore: $(5 \div 6.5) \times 14 = 10.76\text{mm}$ actual bone available

NOTE: A 2mm margin of safety, from the apical end of the implant to the adjacent vital structure, should be considered.

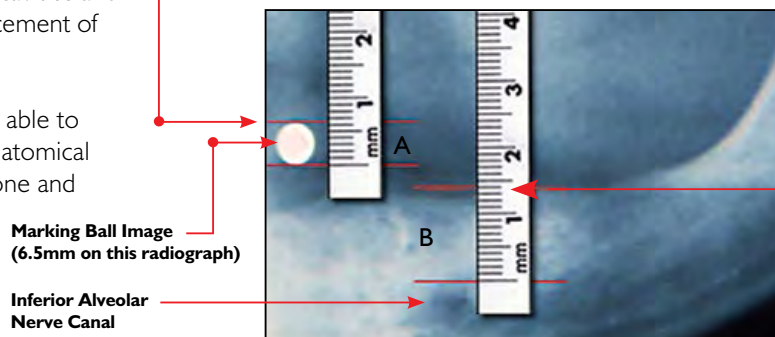

Marking Ball Image
(6.5mm on this radiograph)

Inferior Alveolar
Nerve Canal

Top-Down Treatment Planning

In its simplest form, top-down treatment planning refers to a guideline whereby the desired restorative result is considered first, leading to consideration of the appropriate prosthetic platform and subsequent implant selection based on bony anatomy, location and size of the missing tooth.

A top-down treatment planning methodology will provide maximum biomechanical stability and allow for soft-tissue flaring by utilizing an implant with a prosthetic platform slightly smaller in diameter than the emergence diameter of the tooth being replaced. The wide selection of BIOMET **3i** Implants allows clinicians to match the size of the prosthetic platform to the restoration it will eventually support, while allowing for different bone volumes and anatomical features at the implant site. Implant and healing

abutment selections are based upon the relationship of several key measurements:

- The emerging dimension of the crown in relation to the diameter of the prosthetic platform of the implant
- The height and diameter of the intended restoration at the tissue exit point
- The bone volume at the implant site in relation to the diameter of the implant body

The Emergence Profile (EP®) Healing Abutment System consists of healing abutments of various diameters and heights for shaping the soft tissue to replicate the geometry and gingival contours of natural dentition.

Implant Indications: Include both straight and pre-angled restorative components.

	3.25mm(D)	3.75mm(D)	4mm(D)	5mm(D)	6mm(D)	4mm(D) X 3.4mm(P)	5mm(D) X 4.1mm(P)	6mm(D) X 5mm(P)
Anterior	✓	✓	✓	✓	✓	✓	✓	✓
Posterior			✓	✓	✓	✓	✓	✓

NOTE: It is recommended that implants less than 4mm diameter not be placed in the posterior regions.

Top-Down Treatment Planning (Cont'd)

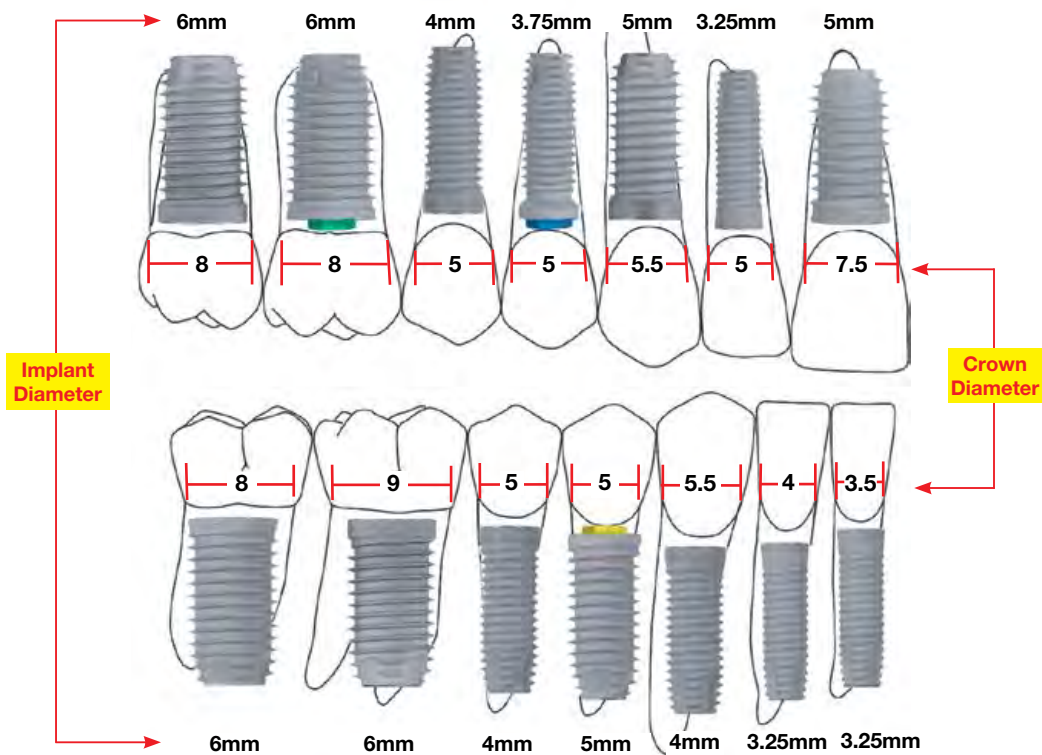
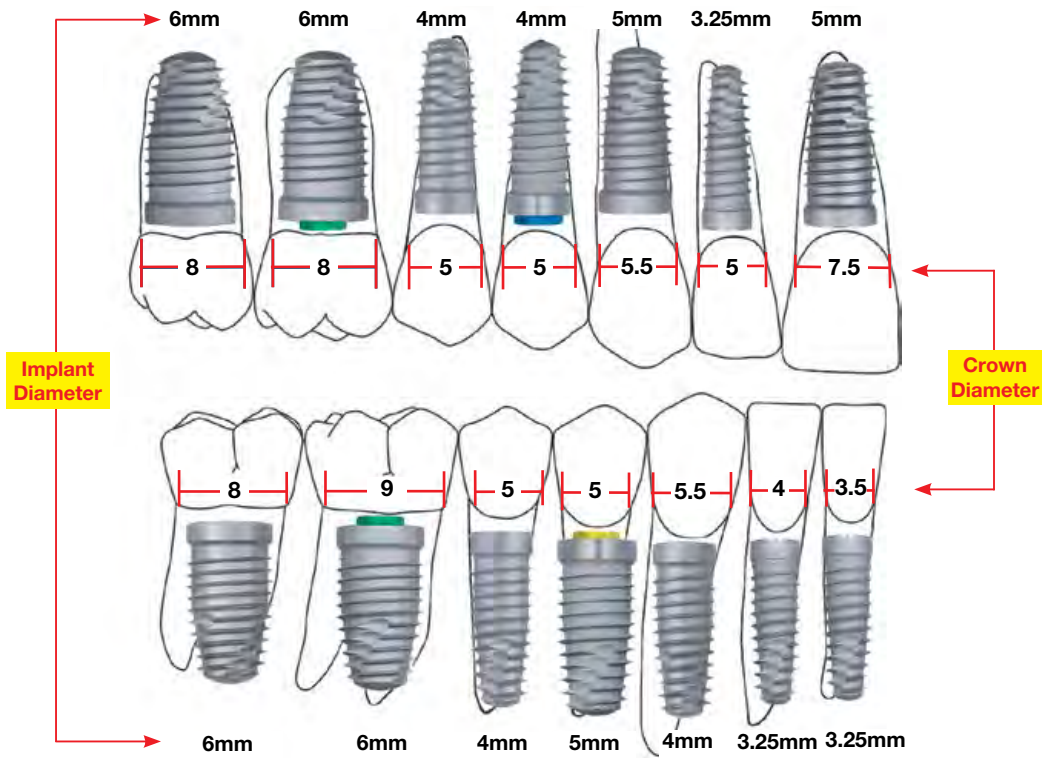

Surgical Precautions

Clinical Considerations:

Actual bone contours can only be evaluated after tissue flaps have been reflected at the time of surgery or with preoperative high quality CT scans. Even if bone dimensions are meticulously measured prior to surgery, the doctor and patient must accept the possibility that inadequate bone anatomy might be discovered during surgery and preclude implant placement.

During the presurgical planning phase, it is important to determine the interocclusal clearance - the actual space available between the alveolar crest and the opposing dentition - to confirm that the available space will accommodate the proposed abutment and the definitive restoration. The height required by the abutment may vary with the type of abutment; therefore, the surgeon and restorative dentist should carefully evaluate the abutment size. The definitive prosthesis should be conceptually designed prior to the placement of the implant.

Diagnostic casts can be used preoperatively to evaluate the residual ridge and to determine the position and angulation of all implants. These casts allow the clinician to evaluate the opposing dentition and its effect on the implant position. A surgical guide stent, which is critical for determining the precise position and angulation of the implant, can be constructed on the diagnostic cast.

Several software companies offer planning software that allow clinicians to plan implant placement three-dimensionally in conjunction with CT scans. From plans created in these software packages, surgical guides can be made to aid in the pre-angulation and placement of implants.

To prevent damage to the bone tissue and to prevent compromising osseointegration by overheating the bone during drilling, copious irrigation with sterile water or saline solution is mandatory during all drilling procedures.

Bone surgery utilizes a high-torque electric drilling unit that can be operated in forward and reverse modes at speeds ranging from 0 to 2000rpm, depending on the surgical requirements. Sharp instruments of the highest quality should be utilized during implant site preparation to reduce possible overheating and trauma to the bone. Minimizing trauma enhances the potential for successful osseointegration.

The time elapsed between surgical placement of the implant and definitive abutment placement can vary or be modified, depending on the quality of the bone at the implantation site, bony response to the implant surface and other implanted materials and the surgeon's assessment of the patient's bone density at the time of the surgical procedure. Extreme care must be taken to avoid excessive force being applied to the implant during this healing period.

Cleaning And Sterilization

Single use drills/burs are supplied sterile and should be properly disposed of after each procedure. Reusable drills/burs and instrumentation are supplied nonsterile and must be sterilized prior to use. Nonsterile items must be removed from the packaging before sterilization.

Multiple sterilizations may affect the flow of fluid through internally irrigated drills. The drills should be inspected following each sterilization cycle to determine if fluid flows through the irrigation ports. Although the surgical drills are constructed of stainless steel, these should be adequately dried prior to packaging for sterilization and again after the sterilization cycle. Reusable drills are recommended to be replaced after 15 osteotomy preparations, subject to the information below.

The end of life for surgical instruments is normally determined by wear and damage. Surgical instruments and instrument cases are susceptible to damage for a variety of reasons including prolonged use, misuse, rough or improper handling. Care must be taken to avoid compromising the intended performance of the instrument.

Visually inspect each instrument before and after each use for damage and/or wear.

To extend the useful life of BIOMET 3i Instruments, certain procedures should always be followed:

Cleaning:

1. After use, place drills into a beaker of plain water, mild soap or specialized cleaning solution.
2. Rinse with tap water for a minimum of two minutes while brushing with a soft bristled brush to remove visible debris. Clean the interior lumen with a thin wire to remove any remaining debris.
3. Place instruments in an ultrasonic bath containing enzymatic detergent for five minutes.* Scrub the instruments again with a soft bristled brush and ream the interior lumen to remove any remaining debris.
4. Rinse and flush the instruments for one minute using tap water.
5. Inspect visually for any remaining bone fragments or debris and scrub as necessary.

Sterilization:

6. Remove the bur block from the surgical tray. Scrub the surgical tray and block with a soft bristle brush and mild soap. Rinse thoroughly.

7. Place the components into the surgical tray and pour ethyl alcohol (do not use rubbing alcohol) over the burs and tray to remove soap residue and minerals from the water. This step is important to help prevent corrosion and spotting. Let the components dry before wrapping.
8. Wrap the surgical tray in paper or autoclave-approved bags twice to prevent a tear of the outer packaging from contaminating sterile instruments.
9. Steam Gravity Sterilization Method
**Kits NPSDK0, NCATD0, NCATD0C, SGKIT, SGTIKIT:
Trays PSDT1, SGTRAY, SGTTRAY:**
Minimum forty (40) minutes at a temperature of 270 – 275°F (132-135°C)

All other Kits and Trays:

Minimum twenty (20) minutes at a temperature of 270-275°F (132-135°C)

or

Pre-vacuum Sterilization Method (All Kits)

Minimum four (4) minutes (four pulses) at a temperature of 270-275°F (132-135°C)

10. Post sterilization, devices should be thoroughly dried to mitigate the risk of stainless corrosion (30 minutes is typical). **NOTE: Drying times may vary according to load size.**

NOTE: Multiple sterilizations may affect the flow of fluid through internally irrigated burs. After each use, prior to the sterilization cycle, ream burs individually with wire to remove any bone fragments or debris that will prevent the flow of water.

It is very important not to remove drills, instrumentation or the surgical tray from the autoclave until the “dry cycle” is complete.

These guidelines DO NOT apply to the cleaning and sterilization of your powered instrumentation. Please follow your powered instrumentation manufacturer’s instructions.

Please refer to P-IFSCSS for complete instructions on the sterilization and care of stainless steel.

NOTE: Due to the individual clinical handling procedures, cleaning methods, bioburden levels, and other conditions, clinicians are responsible for proper sterilization of kits and instruments.

These recommendations have been validated by BIOMET 3i to obtain the following:

Cleaning: An average LOG₁₀ reduction in tag spores to 4.58.
Sterilization: A 10⁻⁶ SAL.

*ENZOL enzymatic detergent was used to validate this process per the manufacturer’s dilution recommendation.



Bone Density

The protocols detailed in this Surgical Manual have been developed to include more specific information about drill selection when working in various bone densities. However, the clinician is responsible for assessing bone density and anatomy when determining the appropriate protocol.

The various bone densities can be characterized by the following:

Dense (Type I) – A thick cortical layer and a very high density trabecular core

Medium (Type II & III) – A cortical layer of moderate thickness with a reasonably dense trabecular core

Soft (Type IV) – A thin cortical layer and a low density trabecular core

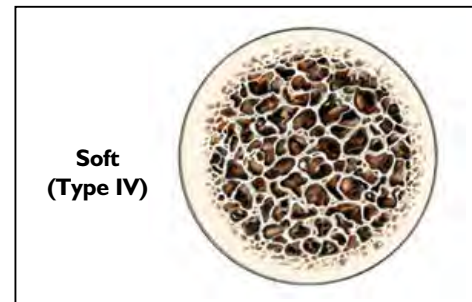
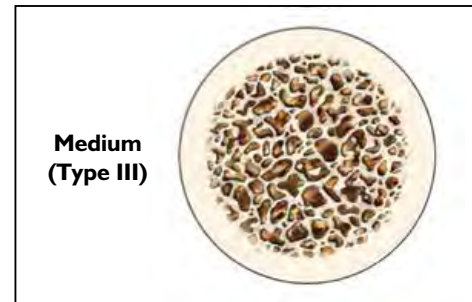
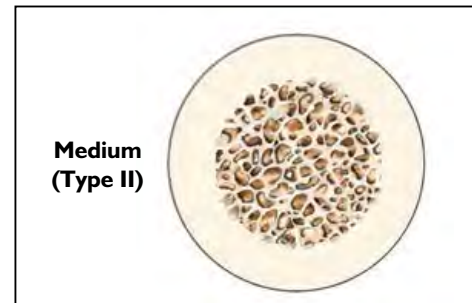
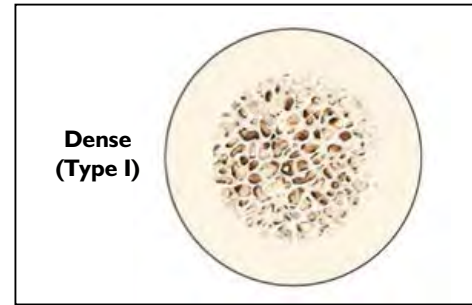

Tapered Implants

Certain® Internal & External Hex Connection

Full OSSEOTITE®
Tapered Certain Implant



Tapered Certain
Platform Switched Implant



Full OSSEOTITE
Tapered Implant



Tapered Implants

Why BIOMET 3i Tapered Implants Are Different

Due to the geometrical differences that exist between a tapered and a parallel walled implant, there are several important technique adjustments that are required.

In all tapered implant placement procedures, **the surgeon should determine the appropriate vertical position of the implant (supracrestal, crestal or subcrestal) at the time of osteotomy preparation.** The surgeon should prepare the tapered osteotomy so that when the implant is fully seated, the implant seating surface is at the desired position. The Tapered Implant Depth/Direction Indicator (NTDI) was designed to simulate the tapered implant position prior to placement.

After preparation of the osteotomy with the final shaping drill, flush the osteotomy with sterile water or saline solution and suction out any remaining debris. Select the corresponding NTDI and place the tapered end into the osteotomy. Check the platform position (crestal or subcrestal) of the NTDI in relation to the adjacent bone. This position locates where the platform of the tapered implant will be positioned when properly placed. If during placement with the drill unit, the tapered implant platform is higher in relation to the bone than was demonstrated with the NTDI platform, the clinician should consider using a hand ratchet to complete the implant placement so that the tapered portion of the implant body conforms correctly with the tapered portion of the osteotomy (Figure 1. Proper Subcrestal Placement).

Over Preparing the osteotomy depth and then placing the implant at a crestal level may result in a conical space around the apical and coronal aspects of the tapered implant minimizing thread engagement (Figure 2. Over Prepared Subcrestal Placement). This placement position may result in decreased implant to osteotomy contact, with contact occurring only along the parallel coronal portion of the implant, resulting in decreased stability of the implant.

Under Preparing the osteotomy depth and then placing the implant more apical relative to the prepared depth may result in the implant stopping short of the desired placement level. The implant may then spin and lose primary stability (Figure 3. Under Prepared Subcrestal Placement).

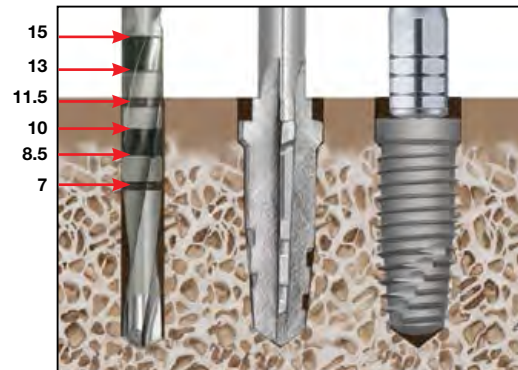

Figure 1
Proper Subcrestal Placement Of 11.5mm Implant

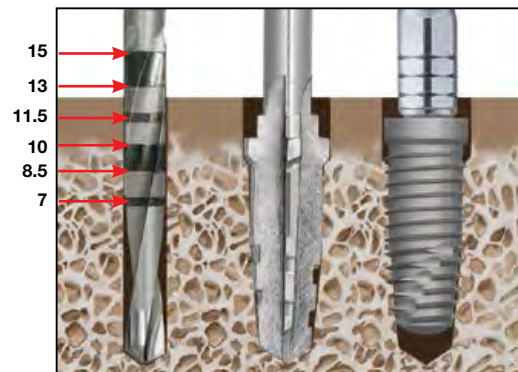

Figure 2
Over Prepared Subcrestal Placement Of 11.5mm Implant

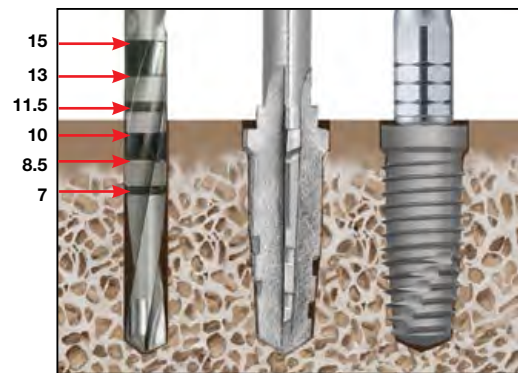

Figure 3
Under Prepared Subcrestal Placement Of 11.5mm Implant

Quad Shaping Drills (QSDs)

Certain® Internal & External Hex Connection Tapered Implants

The Quad Shaping Drills (QSDs) are used to prepare the osteotomy for placement of BIOMET 3i Tapered Implants.

The BIOMET 3i Depth Measurement System includes drill depth marks on the ACT® Twist Drill that correspond to the placement of the implant via a well-established procedure. The BIOMET 3i Protocol follows the principles of protecting the implant from premature loading by placing the implant subcrestally.

The Quad Shaping Drills have been designed with geometrical depth landmarks to assess proper depth rather than laser etched markings. The clinician should become familiar with these depth landmarks to prevent over or under preparation of the osteotomy site.

Shaping Drill Speed:

QSDs should operate between 1200 – 1500rpm.

QSDs cut efficiently; reducing the downward force will allow the drill to cut without detectable chatter.

Shaping Drill Technique:

- For either crestal or subcrestal implant placement, drill to the top of either the crestal or subcrestal depth landmarks on the QSD (full depth - see illustration to the right).
- Do not pump the shaping drill as you might do with a twist drill when creating the osteotomy as it may distort the dimensions of the osteotomy. The shaping drill should be advanced once to full depth, then be removed without any pumping action.
- Once the shaping drill has reached the desired depth, pull it out of the site without running the drill. If the drill does not pull out easily, tap the foot pedal while pulling the drill out. In addition to preserving the integrity of the osteotomy site, this technique maximizes autogenous bone recovery from the shaping drill flutes.
- When placing a tapered implant in soft bone (Type IV), the surgeon should consider undersizing the osteotomy. The final drill diameter should match the implant diameter, but be limited to 8.5mm in length. This will create an osteotomy of proper dimension in the dense cortical bone to receive the implant, but will slightly undersize the osteotomy in the cancellous region.

It is required that the clinician tap the osteotomy when placing a Tapered Implant in dense bone (Type I).

NOTE: During preparation of the osteotomy, the Quad Shaping Drill should advance into the osteotomy using light pressure. The need to push heavily on the shaping drill may indicate the need to replace the shaping drill, the need to tap or that the previous drill depth was inadequate.

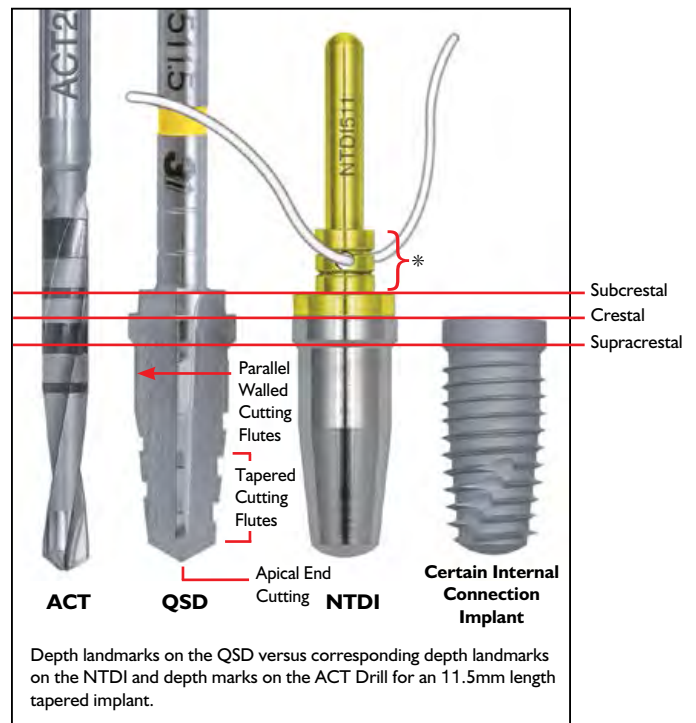

*Gingival Depth Marks - These depth marks are not used in the surgical procedures covered in this manual.

Twist Drill Depth Marking System

Certain® Internal & External Hex Connection Tapered Implants

A 2mm Twist Drill is used to prepare the osteotomy for the sequential Quad Shaping Drills (QSDs) in the tapered surgical protocols. Pages 11-14 outline the guidelines for understanding the depth markings on the Twist Drill System.

Types Of Twist Drills



ITD Reusable Drills

- Internal irrigation lumen
- All thin lines



DT & DTN Disposable Drills

- Without internal irrigation lumen
- Bands
- DTN disposable drills do not have a hub



ACT® Reusable Drills

- Without internal irrigation lumen
- Alternating lines and bands
- No hub

Twist Drill Marks

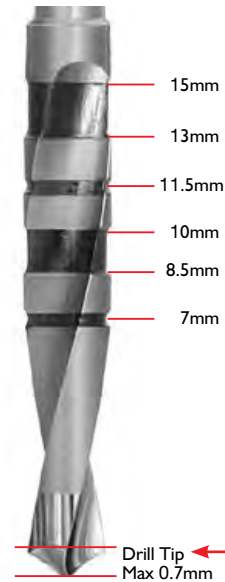

The center of the drill's single line depth marks and the beginning or end of the broad band indicate subcrestal placement for the corresponding length implant.

The length of the drill tip is not included in the depth mark measurement. The drill tip length should be considered when preparing the osteotomy.

The length of the drill tip varies with the diameter of the drill.

Drill Tip Dimensions

Drill Diameter	ITD/DTN/DT Drill Tip Length	ACT Drill Tip Length
2mm	0.6mm	0.6mm
2.3mm	0.7mm	N/A

Twist Drill Depth Marking System (Cont'd)

Certain® Internal & External Hex Connection Tapered Implants

The BIOMET 3i Depth Marks measurement system provides a mark on the drill that corresponds to the placement of the implant via well-established procedures. The BIOMET 3i original protocol follows the principles of protecting the implant from premature loading by placing the implant **subcrestally**.

Drilling Depth

The drilling depth with the Twist Drill will vary depending on the type of placement related to the bone crest.

The depth marks are specific for **subcrestal** implant placement only. There are no specific depth marks on the drills for crestal or supracrestal placement.

The drill depth marks do not indicate implant lengths. Rather, the drill depth marks represent the length of the implant with a standard 1mm cover screw in place. As a result, to place an implant and cover screw **subcrestally** requires drilling to the middle of the single line depth mark or the beginning or end of the broad band depth mark on ACT® Drills. For **crestal** placement, drill halfway before the corresponding depth mark for the implant length. For **supracrestal** placement, the drill depth mark should remain above the bone by 1mm for the cover screw plus the implant collar height. Refer to the diagram at the bottom of page 14 for more information on supracrestal placement.

Certain Internal Connection Implants are packaged with a 0.4mm Cover Screw. However, the protocol for these implants do not differ from the protocol for BIOMET 3i Implants packaged with a 1mm Cover Screw.

Standard Subcrestal Protocol

1mm Cover Screw

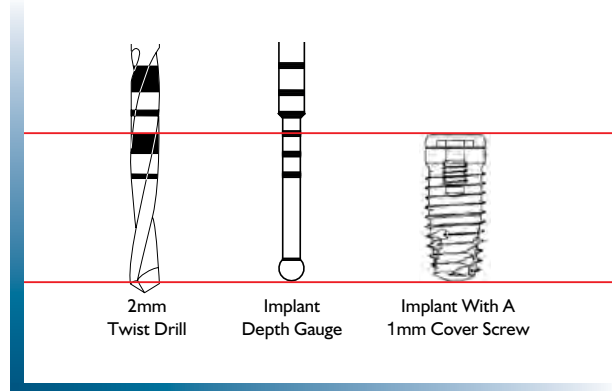

Drilling Depth Comparison

Certain Internal Connection

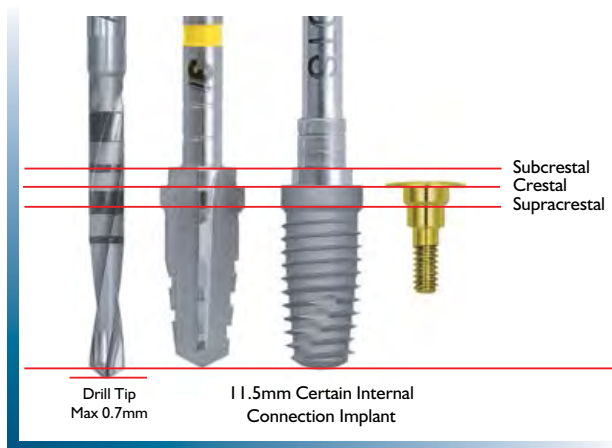

Drilling Depth Comparison

External Hex Connection

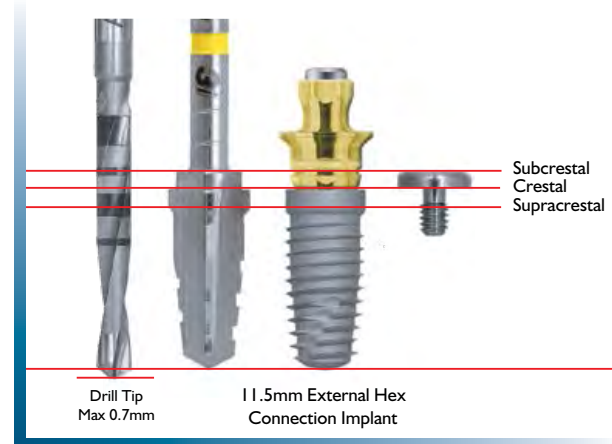

Tapered Implants

Twist Drill Depth Marking System (Cont'd)

Certain® Internal & External Hex Connection Tapered Implants

Labeled vs. Actual Lengths

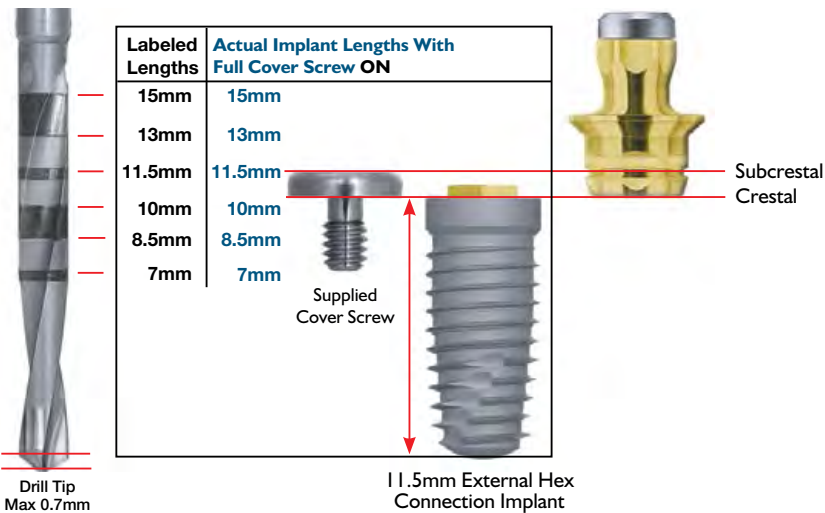
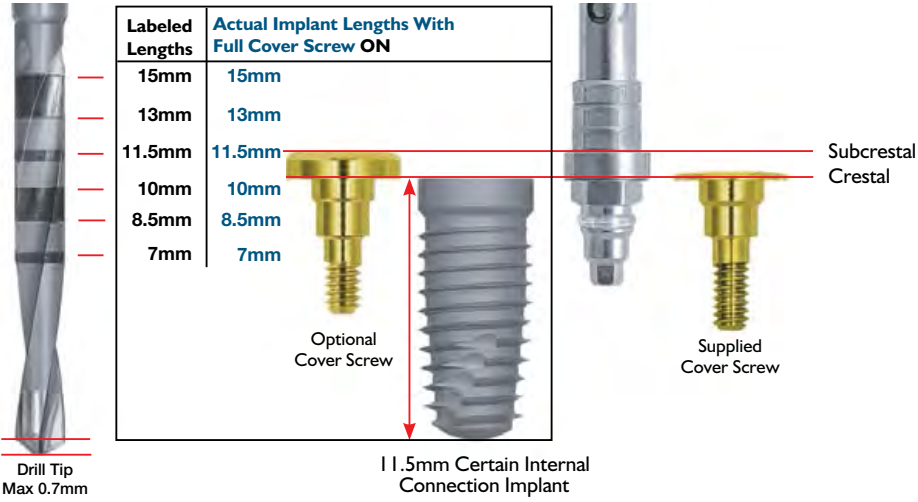

The center of the drill's single line depth marks and the beginning or end of the broad band indicate the length of the implant with a standard 1mm cover screw in place.

The actual implant lengths from the top of the implant collar (platform) to the tip of the implant are shorter by 0.4mm than the labeled length.

The landmarks (grooves) on the Certain Implant Driver Tip act as references during implant placement.

Twist Drill Depth Marking System (Cont'd)

Certain® Internal & External Hex Connection Tapered Implants

Subcrestal Placement

- The implant **platform** will be **1mm (or more) below** the bone crest.
- Mostly used in the anterior region for aesthetics

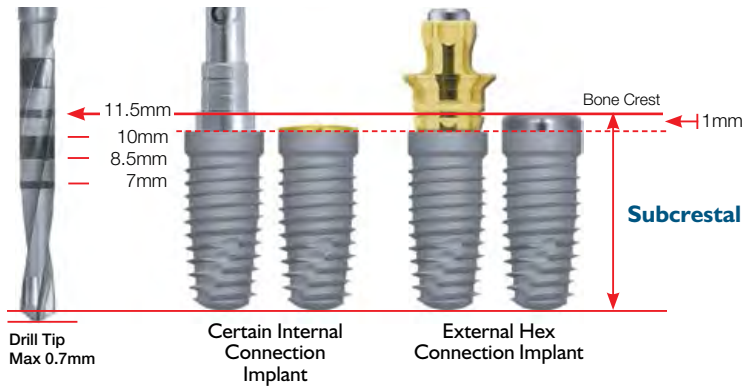

For subcrestal Certain Internal Connection and External Hex Connection Implant placement, drill to the drill depth mark that corresponds to the labeled implant length.

Crestal Placement

- The implant **platform** will be **at** the bone crest.

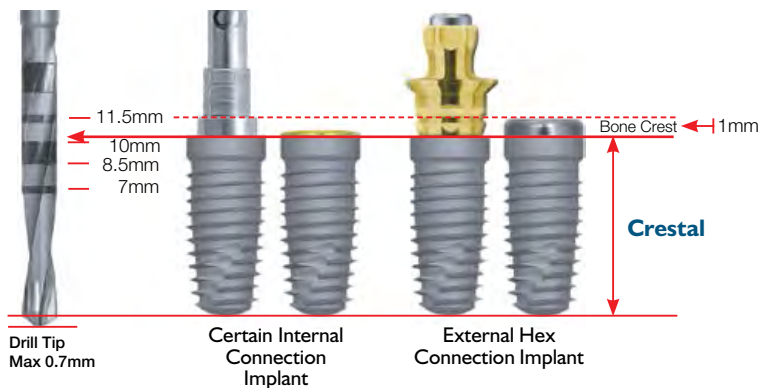

For crestal Certain Internal Connection and External Hex Connection Implant placement, stop drilling **1mm before** the drill depth mark that corresponds to the labeled implant length (1mm equals the traditional cover screw height).

Supracrestal Placement

- The implant **collar** will be **above** the bone crest.

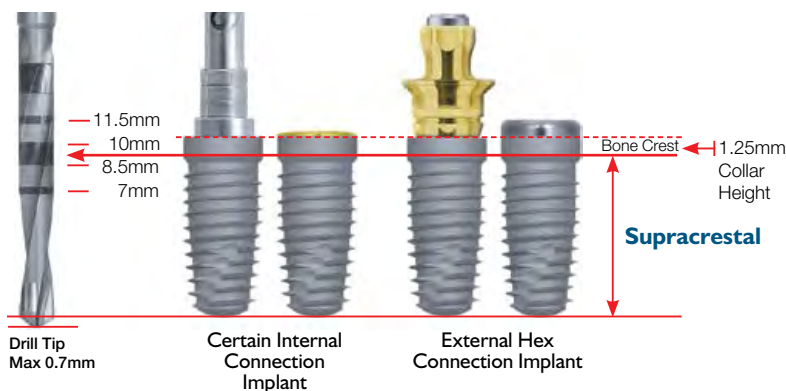

For supracrestal Certain Internal Connection and External Hex Connection Implant placement, stop drilling **2.25mm before** the drill depth mark that corresponds to the labeled implant length (2.25mm equals the 1mm external hex cover screw height plus the 1.25mm implant collar height).

NOTE: A Countersink Drill is not needed for internal or external connection supracrestal implant placement.

Implant Depth/Direction Indicator (NTDI)

Certain® Internal & External Hex Connection Tapered Implants

The Tapered Implant Depth/Direction Indicator is used to simulate the implant platform position prior to placing the implant.

Step 1

When using the NTDI and after preparation of the osteotomy with the final shaping drill, flush the osteotomy with sterile water or saline solution and suction out any remaining debris (Figure 1). This will ensure that the osteotomy is clear of debris that could prevent the NTDI from fully seating.



Figure 1

Step 2

Verify the NTDI platform position in reference to the crest of the bone. This also verifies the depth of the osteotomy that has been created. The NTDI platform should be at the level you desire the implant platform to attain. If the NTDI platform is too high versus the desired position, then re-drilling to the appropriate depth is required. If the NTDI platform is too deep versus the desired position, this indicates some degree of osteotomy over preparation has taken place. To ensure proper engagement of the implant, it must be seated to the depth demonstrated by the NTDI. A longer implant can be considered. The clinician may consider verifying the position of the NTDI with a radiograph (Figure 2).

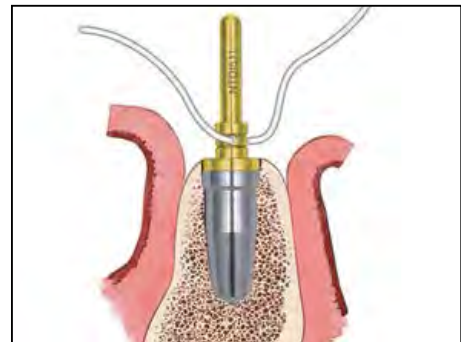

Figure 2

Step 3

When placing the implant, the implant platform should reach the same position that the NTDI platform previously attained. If the implant platform is positioned higher in relation to the crest of the bone than the platform of the NTDI previously demonstrated, or if the surgical motor stalls prior to full placement of the implant due to insufficient torque, then hand ratcheting is recommended to achieve the proper final implant seating position (Figure 3).

These guidelines are designed to help ensure good bone-to-implant contact and primary stability of the implant.



Figure 3

Implant Bone Taps And Bone Tap Kit (NTAPK)

Certain® Internal & External Hex Connection Tapered Implants

Dense Bone Taps

When placing a tapered implant in dense bone (Type I) or when the insertion torque is more than 90Ncm, tapping the osteotomy with a dense bone tap prior to implant placement is required (Figure 1).

Dense Bone Taps are available to fully thread the entire osteotomy. These Dense Bone Taps are both length and diameter specific to correspond to each tapered implant (Figure 2).

Tapered Implant Tap Kit (NTAPK) For Use With Tapered Implants In Dense Bone

When placing a tapered implant, the need to tap the osteotomy may arise, especially in dense bone. The Dense Bone Tap Kit has a specific tap that matches each tapered implant, which then facilitates site specific preparation to aid in final implant placement. Fully seat the tap to the level demonstrated by the NTDI.

NOTE: It is not uncommon for the drill unit to stall before the tap is completely seated. Final seating of the Dense Bone Tap may require the use of the Ratchet Extension and the Ratchet Wrench.



Figure 1



Figure 2



Tapered Implant Tap Kit (NTAPK)

Implant Surgical Tray (QNTSK)

Certain® Internal & External Hex Connection Tapered Implants

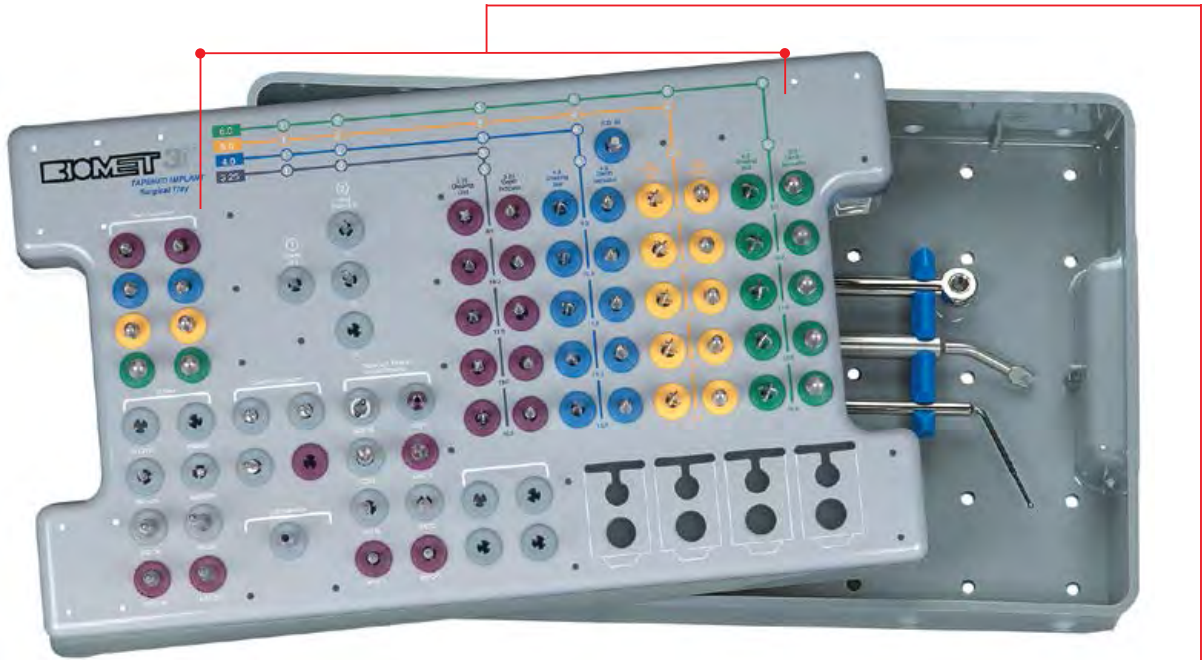

Coordinating The Use Of The Surgical Tray With The Surgical Manual Illustrations:

The Surgical Tray (QNTSK) for tapered implants is numbered to indicate the appropriate steps of the implant placement protocol. The following illustrated implant placement protocol uses the same sequence.

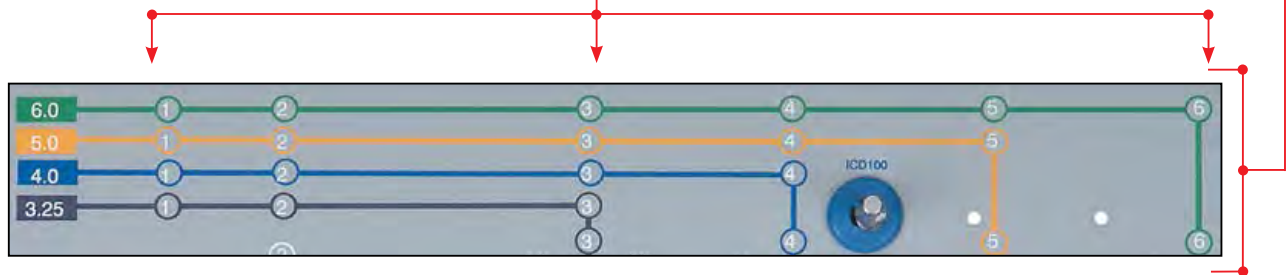

Close-up view of the Surgical Tray illustrating numbering sequence.

Quick Reference Subcrestal Surgical Protocol

Certain® Internal & External Hex Connection Tapered Implants

- The recommended drill speed for all drills is 1200 – 1500rpm.
- The Quad Shaping Drills must be used without pumping actions.
- The recommended implant placement speed is 15 – 20rpm.
- The implant placement torque may exceed 50Ncm.
- Undersizing the osteotomy by one shaping drill diameter is recommended for implant placement in soft bone (Type IV).
- Hand ratcheting may be necessary to fully seat the implant in the osteotomy.
- Certain Internal Connection Driver Tips should be inspected for wear before use.
- It is recommended that reusable drills be replaced after 15 uses.
- **Tapping is required for implant placement in dense bone (Type I) or when the insertion torque is more than 90Ncm.**

D = Diameter
P = Platform
L = Length

ACT® Twist Drill Depth Marks

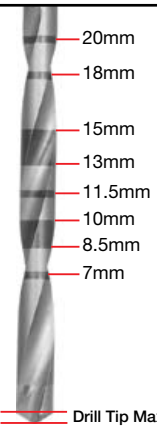

IMPORTANT NOTE: Exceeding insertion torque of more than 90Ncm may deform or strip the driver tip or the implant's internal hex and may possibly delay the surgical procedure.

Tapered 3.25mm(D) Implants



See page 20 for detailed instructions.

Tapered Platform Switched 4mm(D) X 3.4mm(P) & 4mm(D) Implants

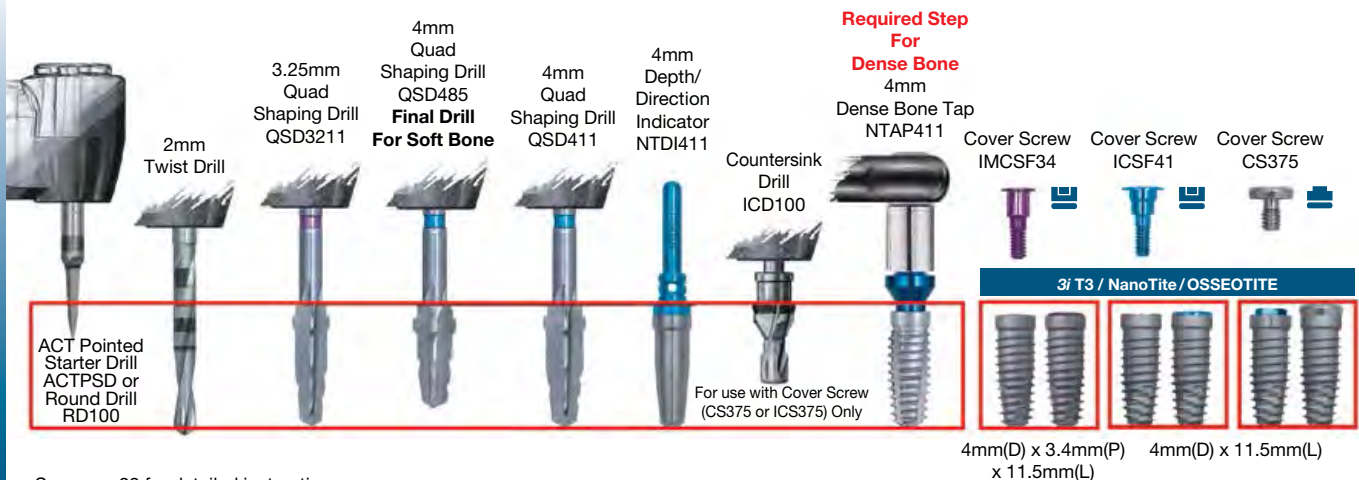

See page 23 for detailed instructions.

Quick Reference Subcrestal Surgical Protocol (Cont'd)

Certain® Internal & External Hex Connection Tapered Implants

- The recommended drill speed for all drills is 1200 – 1500rpm.
- The Quad Shaping Drills must be used without pumping actions.
- The recommended implant placement speed is 15 – 20rpm.
- The implant placement torque may exceed 50Ncm.
- Undersizing the osteotomy by one shaping drill diameter is recommended for implant placement in soft bone (Type IV).
- Hand ratcheting may be necessary to fully seat the implant in the osteotomy.
- Certain Internal Connection Driver Tips should be inspected for wear before use.
- It is recommended that reusable drills be replaced after 15 uses.
- **Tapping is required for implant placement in dense bone (Type I) or when the insertion torque is more than 90Ncm.**

D = Diameter
P = Platform
L = Length

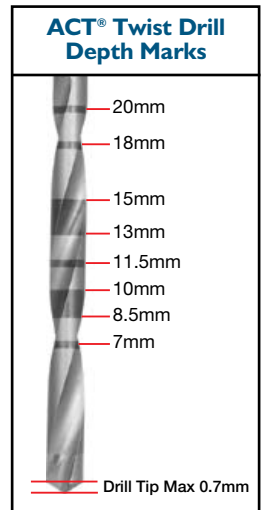

IMPORTANT NOTE: Exceeding insertion torque of more than 90Ncm may deform or strip the driver tip or the implant's internal hex and may possibly delay the surgical procedure.

Tapered Platform Switched 5mm(D) X 4.1mm(P) & 5mm(D) Implants

Required Step For Dense Bone

5mm Quad Shaping Drill QSD585
Final Drill For Soft Bone

5mm Quad Shaping Drill QSD511

5mm Depth/Direction Indicator NTDI511

5mm Dense Bone Tap NTAP511

Cover Screw ICSF41

Cover Screw ICSF50

Cover Screw CS500

3i T3® / NanoTite™ / OSSEOTITE®

5mm(D) x 4.1mm(P) x 11.5mm(L)

5mm(D) x 11.5mm(L)

5mm(D) x 11.5mm(L)

ACT Pointed Starter Drill ACTPSD or Round Drill RD100

2mm Twist Drill

3.25mm Quad Shaping Drill QSD3211

4mm Quad Shaping Drill QSD411

5mm Quad Shaping Drill QSD511

5mm Quad Shaping Drill QSD585

See page 26 for detailed instructions.

Tapered Platform Switched 6mm(D) X 5mm(P) & 6mm(D) Implants

Required Step For Dense Bone

6mm Quad Shaping Drill QSD685
Final Drill For Soft Bone

6mm Quad Shaping Drill QSD611

6mm Depth/Direction Indicator NTDI611

6mm Dense Bone Tap NTAP611

Cover Screw ICSF50

Cover Screw ICSF60

Cover Screw CS600

3i T3 / NanoTite / OSSEOTITE

6mm(D) x 5mm(P) x 11.5mm(L)

6mm(D) x 11.5mm(L)

6mm(D) x 11.5mm(L)

ACT Pointed Starter Drill ACTPSD or Round Drill RD100

2mm Twist Drill

3.25mm Quad Shaping Drill QSD3211

4mm Quad Shaping Drill QSD411

5mm Quad Shaping Drill QSD511

6mm Quad Shaping Drill QSD685

See page 29 for detailed instructions.

Subcrestal Surgical Protocol

Certain® Internal & External Hex Connection

Tapered 3.25mm(D) Implants

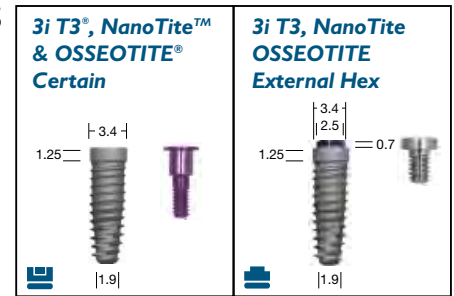

For a quick reference guide to implant placement, please refer to page 18.



1. Once the implant site has been determined, mark the site with the ACT® Pointed Starter Drill or Round Drill and penetrate the cortical bone to the depth mark of the drill. The recommended drill speed is 1200 – 1500rpm. Use copious irrigation with sterile water or saline solution to prevent overheating of the bone during high speed drilling.

- Instrument needed:
ACT Pointed Starter Drill (ACTPSD)
or
Round Drill (RD100 or DR100)

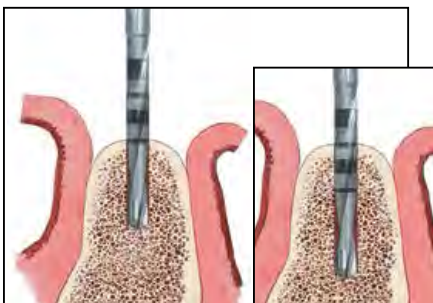

2. Proceed with the Initial Twist Drill to approximately 7mm, and then verify the direction with the narrow end of the Direction Indicator. Thread a suture through the hole to prevent accidental swallowing.

Continue to advance the drill into the osteotomy to the desired depth. The recommended drill speed is 1200 – 1500rpm.

- Instruments needed:
2mm Twist Drill
Direction Indicator (DI100 or DI2310)



3. Verify the direction and position of the preparation by inserting the narrow end of the Direction Indicator into the osteotomy. Thread a suture through the hole to prevent accidental swallowing.

At this step, a Gelb Radiographic Depth Gauge may also be used.

- Instruments needed:
Direction Indicator (DI100 or DI2310)
Gelb Radiographic Depth Gauge (XDGxx)

Final Shaping Drill Step For A Tapered 3.25mm(D) Implant In Soft Bone (Type IV)

In soft bone situations where dense cortical bone is present, it may be necessary to prepare the coronal aspect of the osteotomy.



- 4a. After preparing the osteotomy with the 2mm Twist Drill, finish with a 3.25mm x 8.5mm Quad Shaping Drill (QSD3285). This will create an osteotomy of proper dimension in the dense cortical bone to receive the implant, but will slightly undersize the osteotomy in the cancellous region. The recommended drill speed is 1200 – 1500rpm.

Subcrestal Surgical Protocol

Certain® Internal & External Hex Connection

Tapered 3.25mm(D) Implants (Cont'd)



Preparation For Placement Of A Tapered 3.25mm(D) Implant In Soft Bone (Type IV)

4b. Flush the osteotomy with sterile saline solution. Using suction, remove any remaining drilling debris from the osteotomy before proceeding with the Depth/Direction Indicator (NTDI).



4c. Insert the tapered end of the 3.25mm x 8.5mm NTDI (NTDI3285). This will simulate the position of the implant platform in relation to the crest of the bone. If the position of the NTDI does not indicate proper osteotomy depth, adjust the depth of the osteotomy with the 3.25mm x 8.5mm Quad Shaping Drill or consider a longer length implant if the site has been over prepared. Re-evaluate with the 3.25mm x 8.5mm NTDI. Thread a suture through the hole to prevent accidental swallowing.

Proceed to **step 1** on **page 33** for implant placement.



Final Shaping Drill Step For A Tapered 3.25mm(D) Implant In Medium (Type II And Type III) To Dense Bone (Type I)

5a. Proceed with the 3.25mm Quad Shaping Drill that is the same length as the implant to be placed. The recommended drill speed is 1200 – 1500rpm.

- Instrument needed:
Quad Shaping Drill (QSD32xx)



Preparation For Placement Of A Tapered 3.25mm(D) Implant In Medium (Type II And Type III) To Dense Bone (Type I)

5b. Flush the osteotomy with sterile saline solution. Using suction, remove any remaining drilling debris from the osteotomy before proceeding with the Depth/Direction Indicator (NTDI).

Subcrestal Surgical Protocol

Certain® Internal & External Hex Connection

Tapered 3.25mm(D) Implants (Cont'd)



5c. Insert the tapered end of the 3.25mm (purple) NTDI that corresponds to the length of the implant to be placed. This will simulate the position of the implant platform in relation to the crest of the bone. If the position of the NTDI does not indicate proper osteotomy depth, adjust the depth of the osteotomy with the corresponding 3.25mm Quad Shaping Drill or consider a longer length implant if the site has been over prepared. Re-evaluate with a proper length NTDI. Thread a suture through the hole to prevent accidental swallowing.

Proceed to **step 1** on **page 33** for implant placement.

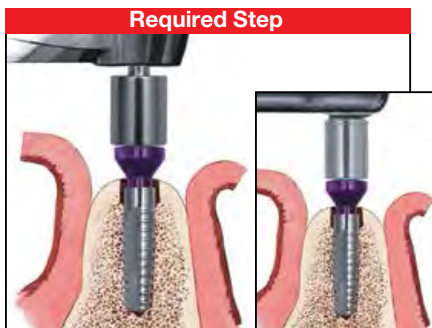

Required Tapping Step: For dense bone (Type I) or when the insertion torque is more than 90Ncm.

If placing a 3.25mm(D) implant in dense bone (Type I) or when the insertion torque is more than 90Ncm, tapping with a Dense Bone Tap is required.

Using the Handpiece Connector, advance the tap into the prepared site at approximately 15 – 20rpm. It is not uncommon for the drill unit to stall before the tap is completely seated. Final seating of the Dense Bone Tap may require the use of the Ratchet Extension and the Ratchet Wrench. Fully seat the tap to the level demonstrated by the NTDI.

- Instruments needed:
 - Handpiece Connector (MDR10)
 - Dense Bone Tap (NTAP32xx)
 - Ratchet Extension (RE100 or RE200)
 - Ratchet Wrench (WR150) or High Torque Indicating Ratchet Wrench (H-TIRW)

Proceed to **step 1** on **page 33** for implant placement.

For more information on various **bone densities** please see **page 7**.

Subcrestal Surgical Protocol

Certain® Internal & External Hex Connection

Tapered Platform Switched 4mm(D) x 3.4mm(P) & 4mm(D) Implants

For a quick reference guide to implant placement, please refer to page 18.

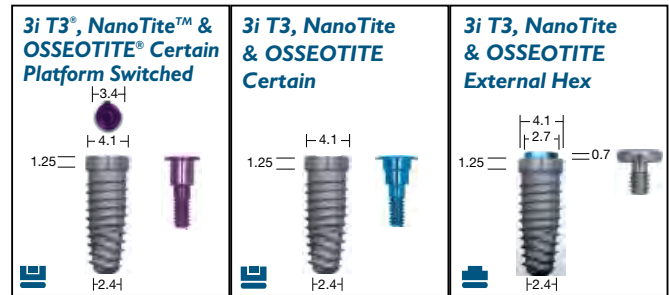

1. Once the implant site has been determined, mark the site with the ACT® Pointed Starter Drill or Round Drill and penetrate the cortical bone to the depth mark of the drill. The recommended drill speed is 1200 – 1500rpm. Use copious irrigation with sterile water or saline solution to prevent overheating of the bone during high speed drilling.

- Instrument needed:
ACT Pointed Starter Drill (ACTPSD)
or
Round Drill (RD100 or DR100)

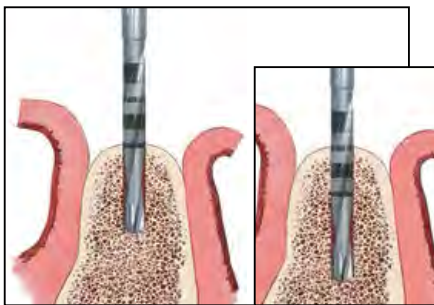

2. Proceed with the Initial Twist Drill to approximately 7mm, and then verify the direction with the narrow end of the Direction Indicator. Thread a suture through the hole to prevent accidental swallowing.

Continue to advance the drill into the osteotomy to the desired depth. The recommended drill speed is 1200 – 1500rpm.

- Instruments needed:
2mm Twist Drill
Direction Indicator (DI100 or DI2310)



3. Verify the direction and position of the preparation by inserting the narrow end of the Direction Indicator into the osteotomy. Thread a suture through the hole to prevent accidental swallowing.

At this step, a Gelb Radiographic Depth Gauge may also be used.

- Instruments needed:
Direction Indicator (DI100 or DI2310)
Gelb Radiographic Depth Gauge (XDGxx)



4. Proceed with the 3.25mm Quad Shaping Drill that is the same length as the implant to be placed. The recommended drill speed is 1200 – 1500rpm.

- Instrument needed:
Quad Shaping Drill (QSD32xx)

Subcrestal Surgical Protocol

Certain® Internal & External Hex Connection

Tapered Platform Switched 4mm(D) x 3.4mm(P) & 4mm(D) Implants (Cont'd)



Final Shaping Drill Step For A Tapered Platform Switched 4mm(D) x 3.4mm(P) And 4mm(D) Implant In Soft Bone (Type IV)

In soft bone situations where dense cortical bone is present, it may be necessary to prepare the coronal aspect of the osteotomy.

- 5a.** After preparing the osteotomy with the 3.25mm Quad Shaping Drill, finish with a 4mm x 8.5mm Quad Shaping Drill (QSD485). This will create an osteotomy of proper dimension in the dense cortical bone to receive the implant, but will slightly undersize the osteotomy in the cancellous region. The recommended drill speed is 1200 – 1500rpm.



Preparation For Placement Of A Tapered Platform Switched 4mm(D) x 3.4mm(P) And 4mm(D) Implant In Soft Bone (Type IV)

- 5b.** Flush the osteotomy with sterile saline solution. Using suction, remove any remaining drilling debris from the osteotomy before proceeding with the Depth/Direction Indicator (NTDI).



- 5c.** Insert the tapered end of the 4mm x 8.5mm NTDI (NTDI485). This will simulate the position of the implant platform in relation to the crest of the bone. If the position of the NTDI does not indicate proper osteotomy depth, adjust the depth of the osteotomy with the 4mm x 8.5mm Quad Shaping Drill or consider a longer length implant if the site has been over prepared. Re-evaluate with the 4mm x 8.5mm NTDI. Thread a suture through the hole to prevent accidental swallowing.

IMPORTANT NOTE: When placing a 4mm(D) x 3.4mm(P) and 4mm(D) implant subcrestally, an ICD100 Countersink Drill should be used to prepare the ridge before placing the implant. The ICD100 is not required for crestal and supracrestal placement of these implants.

Proceed to **step 1** on **page 33** for implant placement.

Final Shaping Drill Step For A Tapered Platform Switched 4mm(D) x 3.4mm(P) And 4mm(D) Implant In Medium (Type II And Type III) To Dense Bone (Type I)

- 6a.** Resume preparing the osteotomy with the 4mm Quad Shaping Drill that is the same length as the implant to be placed. The recommended drill speed is 1200 – 1500rpm.

- Instrument needed:
Quad Shaping Drill (QSD4xx)



Subcrestal Surgical Protocol

Certain® Internal & External Hex Connection

Tapered Platform Switched 4mm(D) x 3.4mm(P) & 4mm(D) Implants (Cont'd)



Preparation For Placement Of A Tapered Platform Switched 4mm(D) x 3.4mm(P) And 4mm(D) Implant In Medium (Type II And Type III) To Dense Bone (Type I)

6b. Flush the osteotomy with sterile saline solution. Using suction, remove any remaining drilling debris from the osteotomy before proceeding with the Depth/Direction Indicator (NTDI).



6c. Insert the tapered end of the 4mm (blue) NTDI that corresponds to the length of the implant to be placed. This will simulate the position of the implant platform in relation to the crest of the bone. If the position of the NTDI does not indicate proper osteotomy depth, adjust the depth of the osteotomy with the corresponding 4mm Quad Shaping Drill or consider a longer length implant if the site has been over prepared. Re-evaluate with a proper length NTDI. Thread a suture through the hole to prevent accidental swallowing.

Proceed to **step 1** on **page 33** for implant placement.



6d. To accommodate the Cover Screw (ICS375 or CS375) for the 4mm(D) implant, use a Countersink Drill (ICD100). This step is not necessary with the flat cover screw packaged with Certain Internal Connection Implants. The recommended drill speed is 1200 – 1500rpm.

IMPORTANT NOTE: When placing a 4mm(D) implant subcrestally, an ICD100 Countersink Drill should be used to prepare the ridge before placing the implant. The ICD100 is not required for crestal and supracrestal placement of these implants.



Required Tapping Step: For dense bone (Type I) or when the insertion torque is more than 90Ncm.

If placing a 4mm(D) x 3.4mm(P) or 4mm(D) implant in dense bone (Type I) or when the insertion torque is more than 90Ncm, tapping with a Dense Bone Tap is required. Using the Handpiece Connector, advance the tap into the prepared site at approximately 15 – 20rpm. It is not uncommon for the drill unit to stall before the tap is completely seated. Final seating of the Dense Bone Tap may require the use of the Ratchet Extension and the Ratchet Wrench. Fully seat the tap to the level demonstrated by the NTDI.

- Instruments needed:
 - Handpiece Connector (MDR10)
 - Dense Bone Tap (NTAP4xx)
 - Ratchet Extension (RE100 or RE200)
 - Ratchet Wrench (WR150) or High Torque Indicating Ratchet Wrench (H-TIRW)

Proceed to **step 1** on **page 33** for implant placement.

For more information on various **bone densities** please see **page 7**.

Subcrestal Surgical Protocol

Certain® Internal & External Hex Connection

Tapered Platform Switched 5mm(D) x 4.1mm(P) & 5mm(D) Implants

For a quick reference guide to implant placement, please refer to page 19.

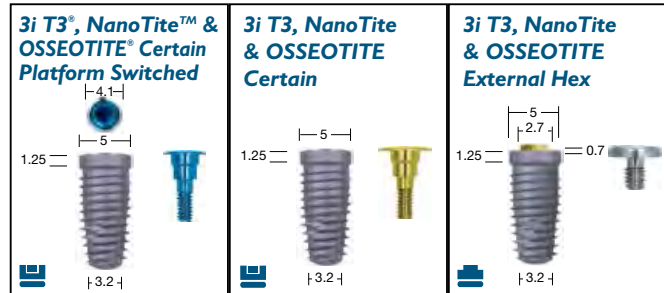

1. Once the implant site has been determined, mark the site with the ACT® Pointed Starter Drill or Round Drill and penetrate the cortical bone to the depth mark of the drill. The recommended drill speed is 1200 – 1500rpm. Use copious irrigation with sterile water or saline solution to prevent overheating of the bone during high speed drilling.

- Instrument needed:
ACT Pointed Starter Drill (ACTPSD)
or
Round Drill (RD100 or DR100)

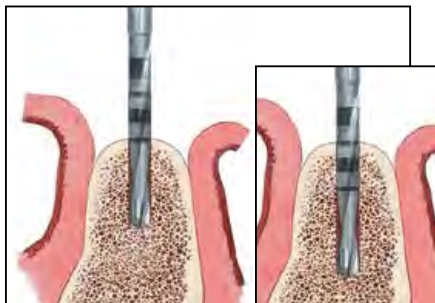

2. Proceed with the Initial Twist Drill to approximately 7mm, and then verify the direction with the narrow end of the Direction Indicator. Thread a suture through the hole to prevent accidental swallowing.

Continue to advance the drill into the osteotomy to the desired depth. The recommended drill speed is 1200 – 1500rpm.

- Instruments needed:
2mm Twist Drill
Direction Indicator (DI100 or DI2310)



3. Verify the direction and position of the preparation by inserting the narrow end of the Direction Indicator into the osteotomy. Thread a suture through the hole to prevent accidental swallowing.

At this step, a Gelb Radiographic Depth Gauge may also be used.

- Instruments needed:
Direction Indicator (DI100 or DI2310)
Gelb Radiographic Depth Gauge (XDGxx)



4. Proceed with the 3.25mm Quad Shaping Drill that is the same length as the implant to be placed. The recommended drill speed is 1200 – 1500rpm.

- Instrument needed:
Quad Shaping Drill (QSD32xx)

Subcrestal Surgical Protocol

Certain® Internal & External Hex Connection

Tapered Platform Switched 5mm(D) x 4.1mm(P) & 5mm(D) Implants (Cont'd)



4. Resume preparing the osteotomy with the 4mm Quad Shaping Drill that is the same length as the implant to be placed. The recommended drill speed is 1200 – 1500rpm.

- Instrument needed:
Quad Shaping Drill (QSD4xx)



Final Shaping Drill Step For A Tapered Platform Switched 5mm(D) x 4.1mm(P) And 5mm(D) Implant In Soft Bone (Type IV)

In soft bone situations where dense cortical bone is present, it may be necessary to prepare the coronal aspect of the osteotomy.

- 6a. After preparing the osteotomy with the 4mm Quad Shaping Drill, finish with a 5mm x 8.5mm Quad Shaping Drill (QSD585). This will create an osteotomy of proper dimension in the dense cortical bone to receive the implant, but will slightly undersize the osteotomy in the cancellous region. The recommended drill speed is 1200 – 1500rpm.



Preparation For Placement Of A Tapered Platform Switched 5mm(D) x 4.1mm(P) And 5mm(D) Implant In Soft Bone (Type IV)

- 6b. Flush the osteotomy with sterile saline solution. Using suction, remove any remaining drilling debris from the osteotomy before proceeding with the Depth/Direction Indicator (NTDI).



- 6c. Insert the tapered end of the 5mm x 8.5mm NTDI (NTDI585). This will simulate the position of the implant platform in relation to the crest of the bone. If the position of the NTDI does not indicate proper osteotomy depth, adjust the depth of the osteotomy with the 5mm x 8.5mm Quad Shaping Drill or consider a longer length implant if the site has been over prepared. Re-evaluate with the 5mm x 8.5mm NTDI. Thread a suture through the hole to prevent accidental swallowing.

Proceed to **step 1** on **page 33** for implant placement.

Subcrestal Surgical Protocol

Certain® Internal & External Hex Connection

Tapered Platform Switched 5mm(D) x 4.1mm(P) & 5mm(D) Implants (Cont'd)



Final Shaping Drill Step For A Tapered Platform Switched 5mm(D) x 4.1mm(P) And 5mm(D) Implant In Medium (Type II And Type III) To Dense Bone (Type I)

7a. Resume preparing the osteotomy with the 5mm Quad Shaping Drill that is the same length as the implant to be placed. The recommended drill speed is 1200 – 1500rpm.

- Instrument needed:
Quad Shaping Drill (QSD5xx)



Preparation For Placement Of A Tapered Platform Switched 5mm(D) x 4.1mm(P) And 5mm(D) Implant In Medium (Type II and Type III) To Dense Bone (Type I)

7b. Flush the osteotomy with sterile saline solution. Using suction, remove any remaining drilling debris from the osteotomy before proceeding with the Depth/Direction Indicator (NTDI).

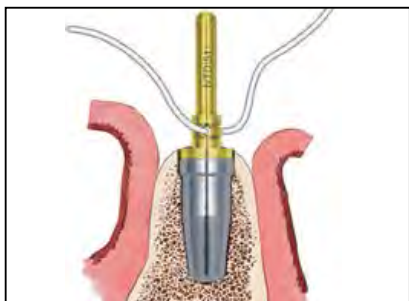

7c. Insert the tapered end of the 5mm (yellow) NTDI that corresponds to the length of the implant to be placed. This will simulate the position of the implant platform in relation to the crest of the bone. If the position of the NTDI does not indicate proper osteotomy depth, adjust the depth of the osteotomy with the corresponding 5mm Quad Shaping Drill or consider a longer length implant if the site has been over prepared. Re-evaluate with a proper length NTDI. Thread a suture through the hole to prevent accidental swallowing.

Proceed to **step 1** on **page 33** for implant placement.

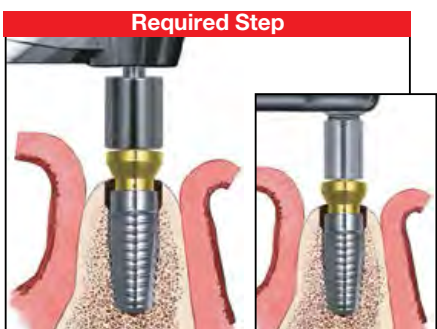

Required Tapping Step: For dense bone (Type I) or when the insertion torque is more than 90Ncm.

If placing a 5mm(D) x 4.1mm(P) or 5mm(D) implant in dense bone (Type I) or when the insertion torque is more than 90Ncm, tapping with a Dense Bone Tap is required. Using the Handpiece Connector, advance the tap into the prepared site at approximately 15 – 20rpm. It is not uncommon for the drill unit to stall before the tap is completely seated. Final seating of the Dense Bone Tap may require the use of the Ratchet Extension and the Ratchet Wrench. Fully seat the tap to the level demonstrated by the NTDI.

- Instruments needed:
Handpiece Connector (MDR10)
Dense Bone Tap (NTAP5xx)
Ratchet Extension (RE100 or RE200)
Ratchet Wrench (WR150) or High Torque Indicating Ratchet Wrench (H-TIRW)

Proceed to **step 1** on **page 33** for implant placement.

For more information on various **bone densities** please see **page 7**.

Subcrestal Surgical Protocol

Certain® Internal & External Hex Connection

Tapered Platform Switched 6mm(D) x 5mm(P) & 6mm(D) Implants

For a quick reference guide to implant placement, please refer to page 19.

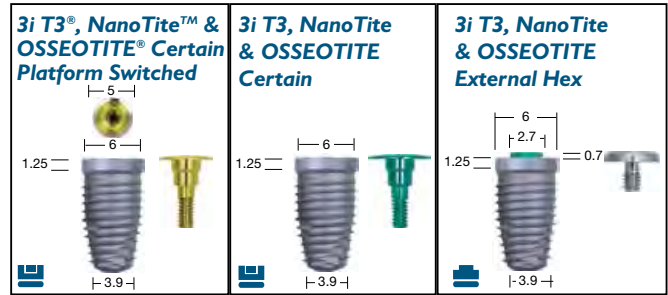

1. Once the implant site has been determined, mark the site with the ACT® Pointed Starter Drill or Round Drill and penetrate the cortical bone to the depth mark of the drill. The recommended drill speed is 1200 – 1500rpm. Use copious irrigation with sterile water or saline solution to prevent overheating of the bone during high speed drilling.

- Instrument needed:
ACT Pointed Starter Drill (ACTPSD)
or
Round Drill (RD100 or DR100)



2. Proceed with the Initial Twist Drill to approximately 7mm, and then verify the direction with the narrow end of the Direction Indicator. Thread a suture through the hole to prevent accidental swallowing.

Continue to advance the drill into the osteotomy to the desired depth. The recommended drill speed is 1200 – 1500rpm.

- Instruments needed:
2mm Twist Drill
Direction Indicator (DI100 or DI2310)



3. Verify the direction and position of the preparation by inserting the narrow end of the Direction Indicator into the osteotomy. Thread a suture through the hole to prevent accidental swallowing.

At this step, a Gelb Radiographic Depth Gauge may also be used.

- Instruments needed:
Direction Indicator (DI100 or DI2310)
Gelb Radiographic Depth Gauge (XDGxx)



4. Proceed with the 3.25mm Quad Shaping Drill that is the same length as the implant to be placed. The recommended drill speed is 1200 – 1500rpm.

- Instrument needed:
Quad Shaping Drill (QSD32xx)

Subcrestal Surgical Protocol

Certain® Internal & External Hex Connection

Tapered Platform Switched 6mm(D) x 5mm(P) & 6mm(D) Implants (Cont'd)



5. Resume preparing the osteotomy with the 4mm Quad Shaping Drill that is the same length as the implant to be placed. The recommended drill speed is 1200 – 1500rpm.

- Instrument needed:
Quad Shaping Drill (QSD4xx)



6. Resume preparing the osteotomy with the 5mm Quad Shaping Drill that is the same length as the implant to be placed. The recommended drill speed is 1200 – 1500rpm.

- Instrument needed:
Quad Shaping Drill (QSD5xx)



Final Shaping Drill Step For A Tapered Platform Switched 6mm(D) x 5mm(P) And 6mm(D) Implant In Soft Bone (Type IV)

In soft bone situations where dense cortical bone is present, it may be necessary to prepare the coronal aspect of the osteotomy.

- 7a. After preparing the osteotomy with the 5mm Quad Shaping Drill, finish with a 6mm x 8.5mm Quad Shaping Drill (QSD685). This will create an osteotomy of proper dimension in the dense cortical bone to receive the implant, but will slightly undersize the osteotomy in the cancellous region. The recommended drill speed is 1200 – 1500rpm.



Preparation For Placement Of A Tapered Platform Switched 6mm(D) x 5mm(P) And 6mm(D) Implant In Soft Bone (Type IV)

- 7b. Flush the osteotomy with sterile saline solution. Using suction, remove any remaining drilling debris from the osteotomy before proceeding with the Depth/Direction Indicator (NTDI).

Subcrestal Surgical Protocol

Certain® Internal & External Hex Connection

Tapered Platform Switched 6mm(D) x 5mm(P) & 6mm(D) Implants (Cont'd)



- 7c.** Insert the tapered end of the 6mm x 8.5mm NTDI (NTDI685). This will simulate the position of the implant platform in relation to the crest of the bone. If the position of the NTDI does not indicate proper osteotomy depth, adjust the depth of the osteotomy with the 6mm x 8.5mm Quad Shaping Drill or consider a longer length implant if the site has been over prepared. Re-evaluate with the 6mm x 8.5mm NTDI. Thread a suture through the hole to prevent accidental swallowing.

Proceed to **step 1** on **page 33** for implant placement.



Final Shaping Drill Step For A Tapered Platform Switched 6mm(D) x 5mm(P) And 6mm(D) Implant In Medium (Type II And Type III) To Dense Bone (Type I)

- 8a.** Resume preparing the osteotomy with the 6mm Quad Shaping Drill that is the same length as the implant to be placed. The recommended drill speed is 1200 – 1500rpm.

- Instrument needed:
Quad Shaping Drill (QSD6xx)



Preparation For Placement Of A Tapered Platform Switched 6mm(D) x 5mm(P) And 6mm(D) Implant In Medium (Type II And Type III) To Dense Bone (Type I)

- 8b.** Flush the osteotomy with sterile saline solution. Using suction, remove any remaining drilling debris from the osteotomy before proceeding with the Depth/Direction Indicator (NTDI).



- 8c.** Insert the tapered end of the 6mm (green) NTDI that corresponds to the length of the implant to be placed. This will simulate the position of the implant platform in relation to the crest of the bone. If the position of the NTDI does not indicate proper osteotomy depth, adjust the depth of the osteotomy with the corresponding 6mm Quad Shaping Drill or consider a longer length implant if the site has been over prepared. Re-evaluate with a proper length NTDI. Thread a suture through the hole to prevent accidental swallowing.

Proceed to **step 1** on **page 33** for implant placement.

Subcrestal Surgical Protocol

Certain® Internal & External Hex Connection

Tapered Platform Switched 6mm(D) x 5mm(P) & 6mm(D) Implants (Cont'd)

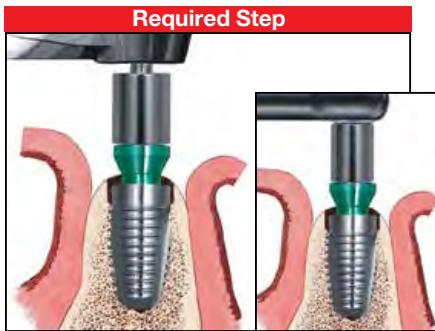

Required Tapping Step: For dense bone (Type I) or when the insertion torque is more than 90Ncm.

If placing a 6mm(D) x 5mm(P) or 6mm(D) implant in dense bone (Type I) or when the insertion torque is more than 90Ncm, tapping with a Dense Bone Tap is required. Using the Handpiece Connector, advance the tap into the prepared site at approximately 15 – 20rpm. It is not uncommon for the drill unit to stall before the tap is completely seated. Final seating of the Dense Bone Tap may require the use of the Ratchet Extension and the Ratchet Wrench. Fully seat the tap to the level demonstrated by the NTDI.

- Instruments needed:
 - Handpiece Connector (MDR10)
 - Dense Bone Tap (NTAP6xx)
 - Ratchet Extension (RE100 or RE200)
 - Ratchet Wrench (WR150) or High Torque Indicating Ratchet Wrench (H-TIRW)

Proceed to **step 1** on **page 33** for implant placement.

For more information on various **bone densities** please see **page 7**.

Subcrestal Implant Placement Protocol

Certain® Internal & External Hex Connection Tapered Implants



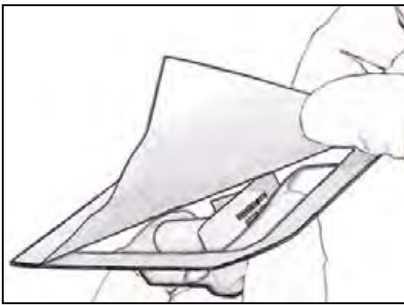

No-Touch™ Delivery System

1.  Remove contents from the implant box.

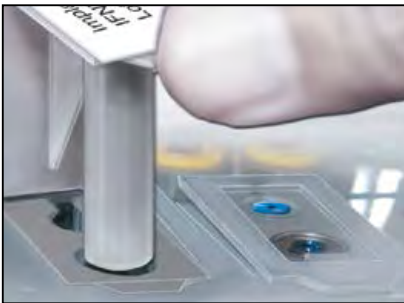

2.  The nonsterile assistant should peel back the tray lid and drop the No-Touch Implant Tray onto the sterile drape.



3.  Wearing sterile gloves, place the No-Touch Implant Tray into the appropriate location on the surgical tray.



4.  Peel back the tray lid to expose the implant and cover screw.

Subcrestal Implant Placement Protocol (Cont'd)

Certain® Internal & External Hex Connection Tapered Implants

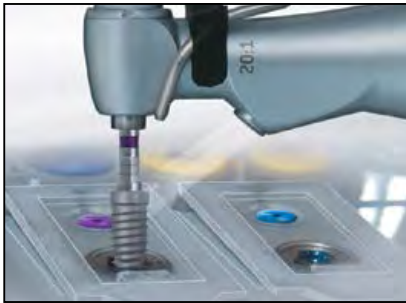

Instructions Specific To A Certain Tapered Platform Switched 4mm(D) x 3.4mm(P) And 3.25mm(D) Implant

5.  For the Certain Internal Connection Implant, pick up the implant from the surgical tray using the dedicated Certain Implant Placement Driver Tip. Carry the implant to the mouth facing upward to prevent accidental dislodging. Due to wear, periodic o-ring replacement is required for the Certain Internal Connection Driver Tip. Certain Internal Connection Driver Tips should be inspected for wear before use. See page 64 for additional technical tips.

- Instrument needed for 4mm(D) x 3.4mm(P) and 3.25mm(D) implants:
Dedicated Certain Standard 3.25mm(D) Driver Tip (IMPPTS or IMPDTL)

NOTE: The Certain Tapered 3.25mm(D) Implant requires the use of a dedicated Certain 3.4mm(D) Driver Tip (IMPPTS or IMPDTL) that is marked with a purple band on the shank. The internal connection configuration is smaller than the Certain 4, 5 and 6mm(D) Standard Implants. The item numbers can be identified on the side of the driver tip.

Proceed to **step 6** on **page 35**.

Or

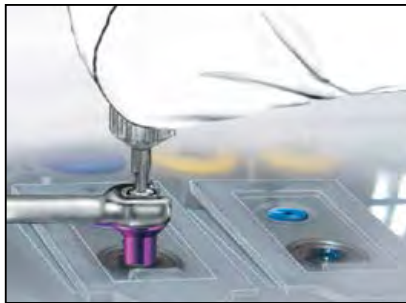

Instructions Specific To An External Hex Tapered 3.25mm(D) Implant

5.  For the External Hex Tapered Implant, pick up the implant mount from the surgical kit using the Open End Wrench. Place the mount onto the implant. Once placed on the implant, hand-tighten the mount screw using the large hex driver. Pick up the implant from the surgical tray using the Handpiece Connector. Carry the implant to the mouth facing upward to prevent accidental dislodging.

- Instruments needed:
Open End Wrench (CW100)
Large Hex Driver (PHD02N)
Implant Mount (MMC03 or MMC15)
Handpiece Connector (MDR10)

Proceed to **step 6** on **page 35**.

Subcrestal Implant Placement Protocol (Cont'd)

Certain® Internal & External Hex Connection Tapered Implants

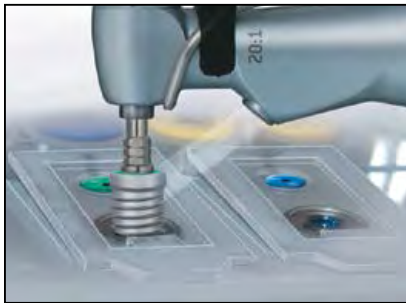

Instructions Specific To A Certain Tapered 4mm Or Larger Diameter Implant

-  For the Certain Internal Connection Tapered Implant, pick up the implant from the surgical tray using the dedicated Certain Implant Placement Driver Tip. Carry the implant to the mouth facing upward to prevent accidental dislodging. Due to wear, periodic o-ring replacement is required for the Certain Internal Connection Driver Tip. Certain Internal Connection Driver Tips should be inspected for wear before use. See page 64 for additional technical tips.

- Instrument needed for 5mm(D) x 4.1mm(P), 6mm(D) x 5mm(P) and 4, 5 and 6mm(D) Tapered Implants:
Dedicated Certain Standard Driver Tip (IIPDTS or IIPDTL)

Or

Instructions Specific To An External Hex Tapered 4mm Or Larger Diameter Implant

-  For the External Hex Tapered Implant, pick up the implant from the surgical tray using the Handpiece Connector.

- Instrument needed:
Handpiece Connector (MDR10)



Optional Step For External Hex Tapered Implant Placement Between Or Adjacent To Teeth:

Remove the pre-attached mount and replace with the standard long mount from the surgical kit for the 4, 5 and 6mm(D) Tapered Implants. Fully seat the mount and hand-tighten the mount screw using the hex driver.

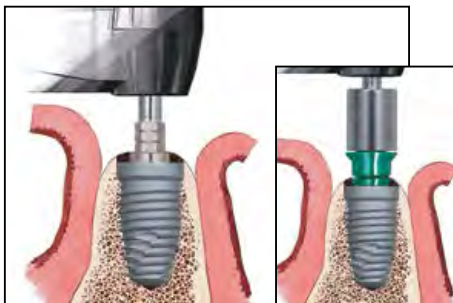

-  Place the implant into the prepared site at approximately 15 – 20rpm. It is not uncommon for the handpiece to stall before the implant is completely seated. The implant position must match what was simulated with the Depth/Direction Indicator (NTDI) or there is a risk of a poor fit between the implant and osteotomy. Tapping is required in dense bone (Type I) or when the insertion torque is more than 90Ncm.

-  Final seating of the implant may require the use of the Ratchet Extension and the Ratchet Wrench.

- Instruments needed:
Ratchet Wrench (WR150) or
High Torque Indicating Ratchet Wrench (H-TIRW)
Certain Ratchet Extension (IRE100U or IRE200U) or
3.25mm(D) Ratchet Extension (IMRE100 or IMRE200)
External Hex Connection Ratchet Extension (RE100 or RE200)

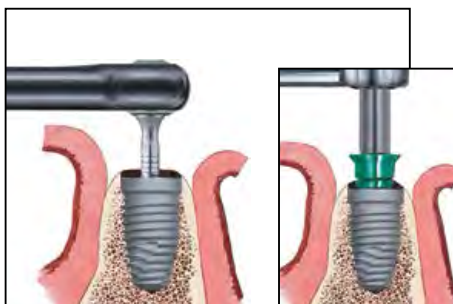

Subcrestal Implant Placement Protocol (Cont'd)

Certain® Internal & External Hex Connection Tapered Implants

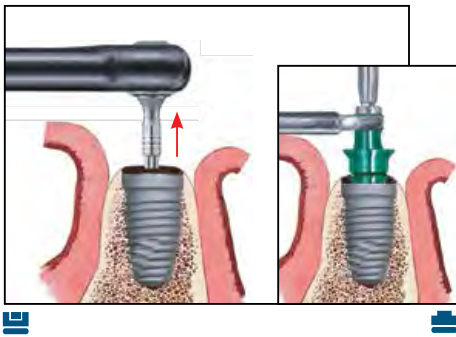

8.  To remove the Certain Ratchet Extension from the implant, lift it straight up and out.

 To remove the implant mount from External Hex Connection Tapered Implants, place the Open End Wrench onto the mount. Loosen the screw at the top of the mount with a Large Hex Driver or the Large Hex Driver Tip inserted into the Right-Angle Driver and rotate counter-clockwise. After the screw is loosened, rotate the Open End Wrench counter-clockwise slightly before removing the mount. The mount may be carried from the mouth with the Open End Wrench.

- Instruments needed:
Open End Wrench (CW100), Large Hex Driver Tip (RASH3) and Right-Angle Driver (CATDB with CADD1) or Large Hex Driver (PHD02N)

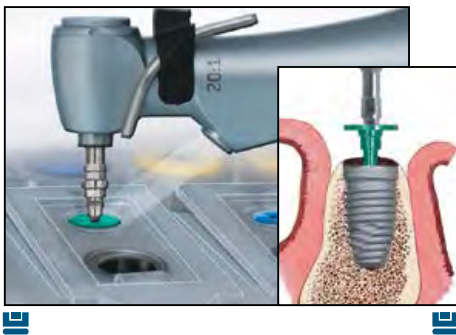



9.  If performing a two-stage surgical protocol, pick up the Cover Screw from the No-Touch™ Implant Tray with the Implant Placement Driver Tip or Large Hex Driver and place it onto the implant.

NOTE: When using the Certain Implant Placement Driver, reduce the torque setting on the drill unit to 10Ncm. Tighten the cover screw to 10Ncm.

- Instruments needed:
Implant Placement Driver Tip (IIPDTS or IIPDTL)
Large Hex Driver (PHD02N)

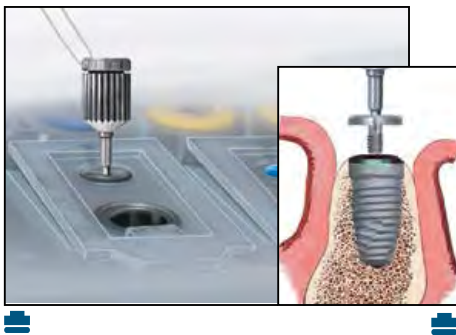
Or



 If performing a two-stage surgical protocol, pick up the Cover Screw from the No-Touch Implant Tray with the Small Hex Driver (PHD00N) and place it onto the implant. Thread a suture through the hole to prevent accidental swallowing. Tighten the cover screw to 10Ncm.

NOTE: At this step, a temporary healing abutment may be placed in lieu of a cover screw when performing a single-stage surgical protocol. Tighten the healing abutment to 20Ncm.

10.  Reposition the soft-tissue flaps and secure with sutures.

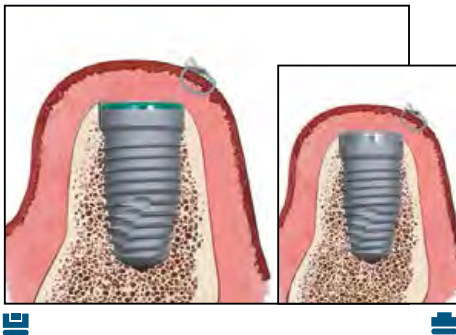

Parallel Walled Implants

Certain® Internal & External Hex Connection

Certain Parallel Walled
Implant



Certain Platform Switched
Implant



External Hex Connection
Parallel Walled Implant



Parallel Walled Implants

Twist Drill Depth Marking System

Certain® Internal & External Hex Connection Parallel Walled Implants

A 2mm Twist Drill is used to prepare the osteotomy for the sequential twist drills in each of the parallel walled surgical protocols. Pages 39-43 outline the guidelines for understanding the depth markings on the Twist Drill System.

Types Of Twist Drills



ITD Reusable Drills

- Internal irrigation lumen
- All thin lines



DT & DTN Disposable Drills

- Without internal irrigation lumen
- Bands
- DTN disposable drills do not have a hub



ACT® Reusable Drills

- Without internal irrigation lumen
- Alternating lines and bands
- No hub

Twist Drill Marks



- 15mm
- 13mm
- 11.5mm
- 10mm
- 8.5mm
- 7mm

The center of the drill's single line depth marks and the beginning or end of the broad band indicate subcrestal placement for the corresponding length implant.

The length of the drill tip is not included in the depth mark measurement. The drill tip length should be considered when preparing the osteotomy.

Drill Tip
Max 1.3mm

The length of the drill tip varies with the diameter of the drill.

Drill Tip Dimensions

Drill Diameter	ITD/DTN/DT Drill Tip Length	ACT Drill Tip Length
2mm	0.6mm	0.6mm
2.3mm	0.7mm	N/A
2.75mm	0.8mm	0.9mm
3mm	0.9mm	0.9mm
3.15mm	1mm	1mm
3.25mm	1mm	1mm
3.85mm	N/A	1.2mm
4.25mm	0.4mm	1.3mm
4.85mm	N/A	1.3mm
5.25mm	0.5mm	1.2mm

Twist Drill Depth Marking System (Cont'd)

Certain® Internal & External Hex Connection Parallel Walled Implants

The BIOMET **3i** Depth Marks measurement system provides a mark on the drill that corresponds to the placement of the implant via well-established procedures. The BIOMET **3i** original protocol follows the principles of protecting the implant from premature loading by placing the implant **subcrestally**.

Drilling Depth

The drilling depth with the Twist Drill will vary depending on the type of placement related to the bone crest.

The depth marks are specific for **subcrestal** implant placement only. There are no specific depth marks on the drills for crestal or supracrestal placement.

The drill depth marks do not indicate implant lengths. Rather, the drill depth marks represent the length of the implant with a standard 1mm cover screw in place. As a result, to place an implant and cover screw **subcrestally** requires drilling to the middle of the single line depth mark or the beginning or end of the broad band depth mark on ACT® Drills. For **crestal** placement, drill halfway before the corresponding depth mark for the implant length. For **supracrestal** placement, the drill depth mark should remain above the bone by 1mm for the cover screw plus the implant collar height. Refer to the diagram at the bottom of page 42 for more information on supracrestal placement.

Certain Internal Connection Implants are packaged with a 0.4mm Cover Screw. However, the protocol for these implants do not differ from the protocol for BIOMET **3i** Implants packaged with a 1mm Cover Screw.

Standard Subcrestal Protocol

1mm Cover Screw

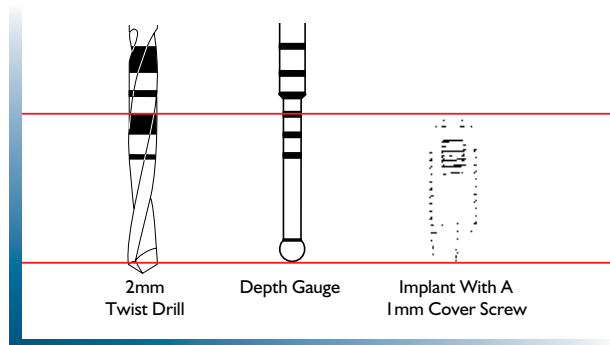

Drilling Depth Comparison

Certain Internal Connection

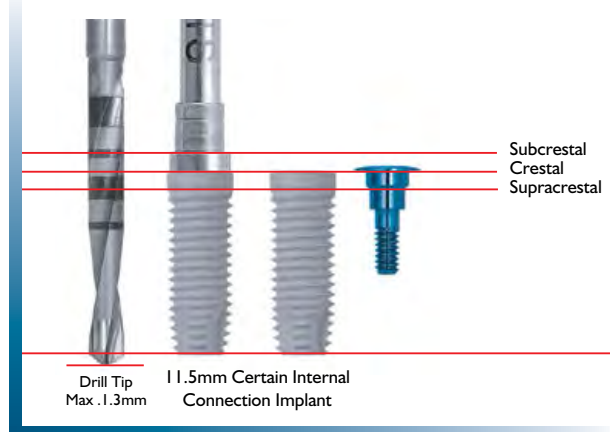

Drilling Depth Comparison

External Hex Connection

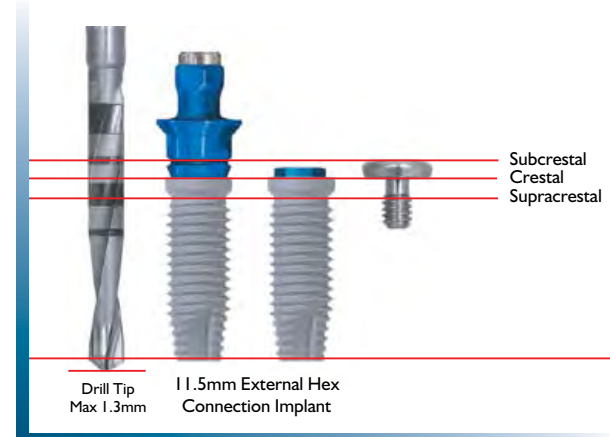

Twist Drill Depth Marking System (Cont'd)

Certain® Internal & External Hex Connection Parallel Walled Implants

Labeled vs. Actual Lengths

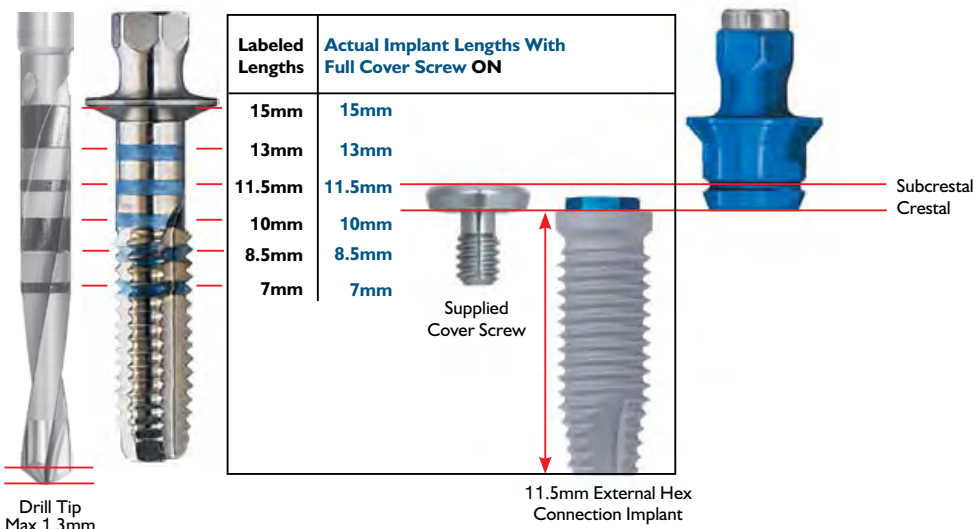
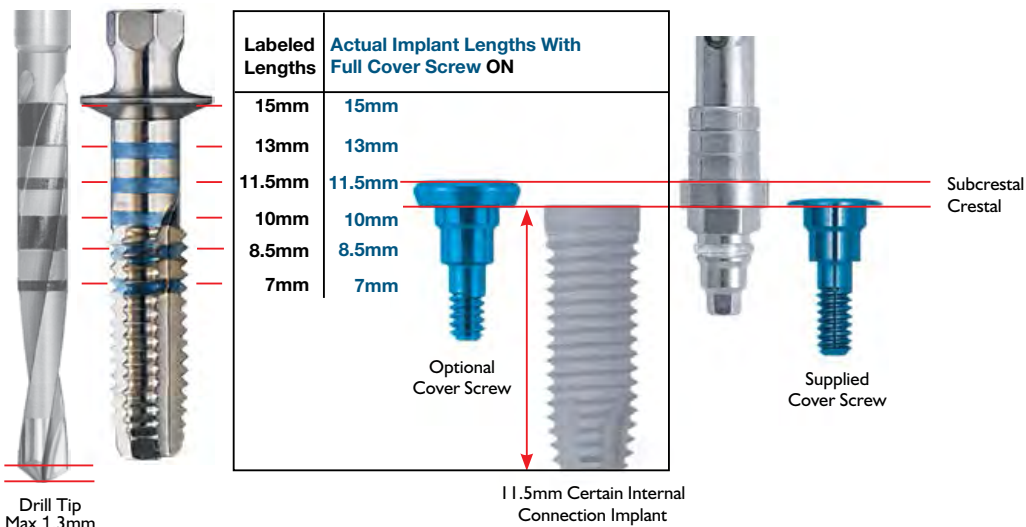

The center of the drill's single line depth marks and the beginning or end of the broad band indicate the length of the implant with a standard 1mm cover screw in place.

The actual implant lengths from the top of the implant collar (platform) to the tip of the implant are shorter by 0.4mm than the labeled length.

The landmarks (grooves) on the Certain Implant Driver Tip act as references during implant placement.

Twist Drill Depth Marking System (Cont'd)

Certain® Internal & External Hex Connection Parallel Walled Implants

Subcrestal Placement

- The implant **platform** will be **1mm (or more) below** the bone crest.
- Mostly used in the anterior region for aesthetics

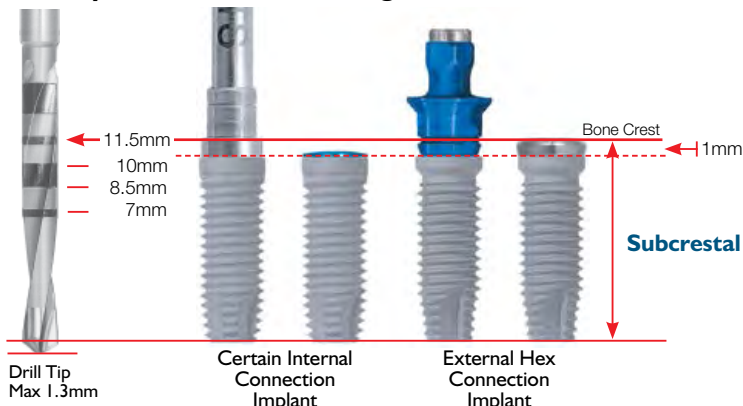

For subcrestal Certain Internal Connection and External Hex Connection Implant placement, drill to the drill depth mark that corresponds to the labeled implant length.

Crestal Placement

- The implant **platform** will be **at** the bone crest.

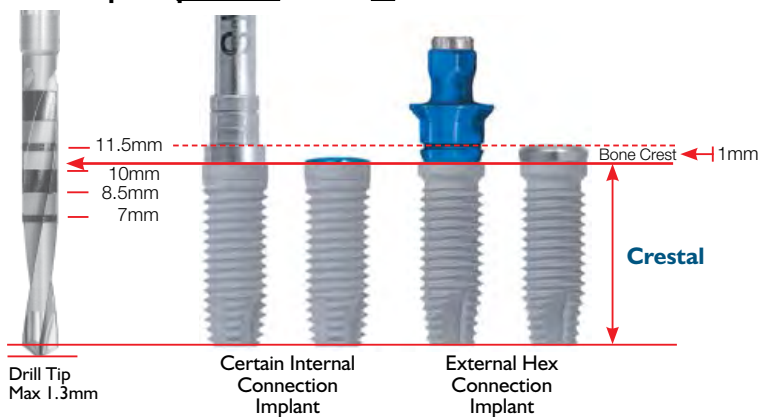

For crestal Certain Internal Connection and External Hex Connection Implant placement, stop drilling **1mm before** the drill depth mark that corresponds to the labeled implant length (1mm equals the traditional cover screw height).

Supracrestal Placement

- The implant **collar** will be **above** the bone crest.

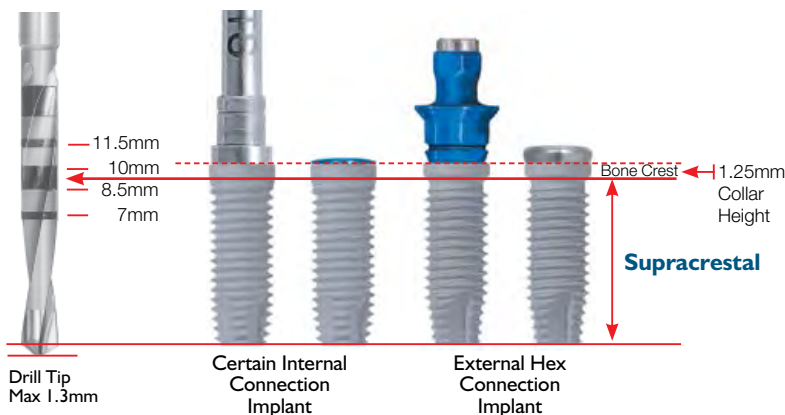

For supracrestal Certain Internal Connection and External Hex Connection Implant placement, stop drilling **2.25mm before** the drill depth mark that corresponds to the labeled implant length (2.25mm equals the external hex cover screw height plus the implant collar height).

NOTE: A Countersink Drill is not needed for internal or external connection supracrestal implant placement.

Twist Drill Depth Marking System (Cont'd)

Certain® Internal & External Hex Connection Parallel Walled Implants

Subcrestal, Crestal & Supracrestal Placement Comparison

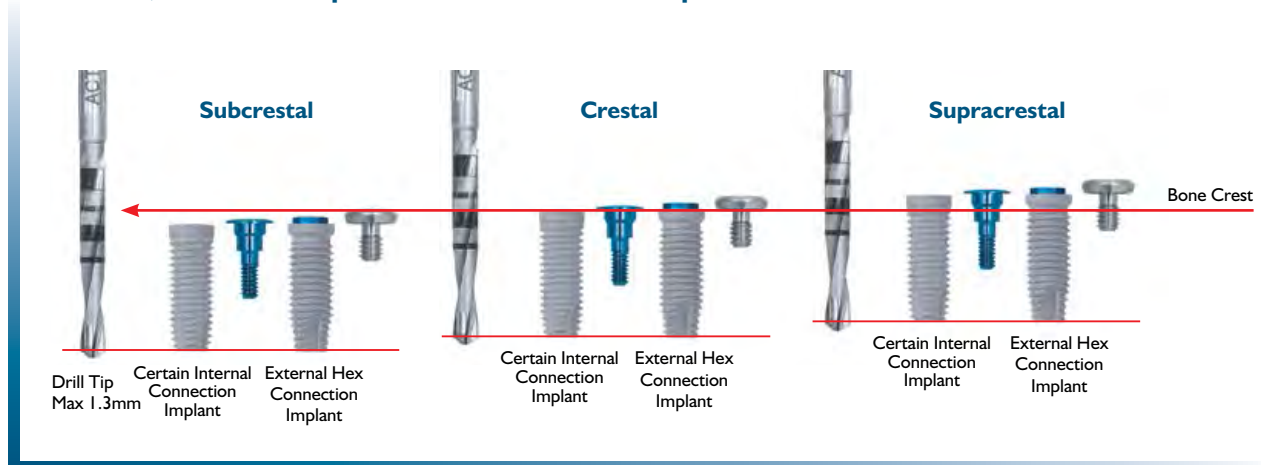

Countersink Drill Depth Marking System

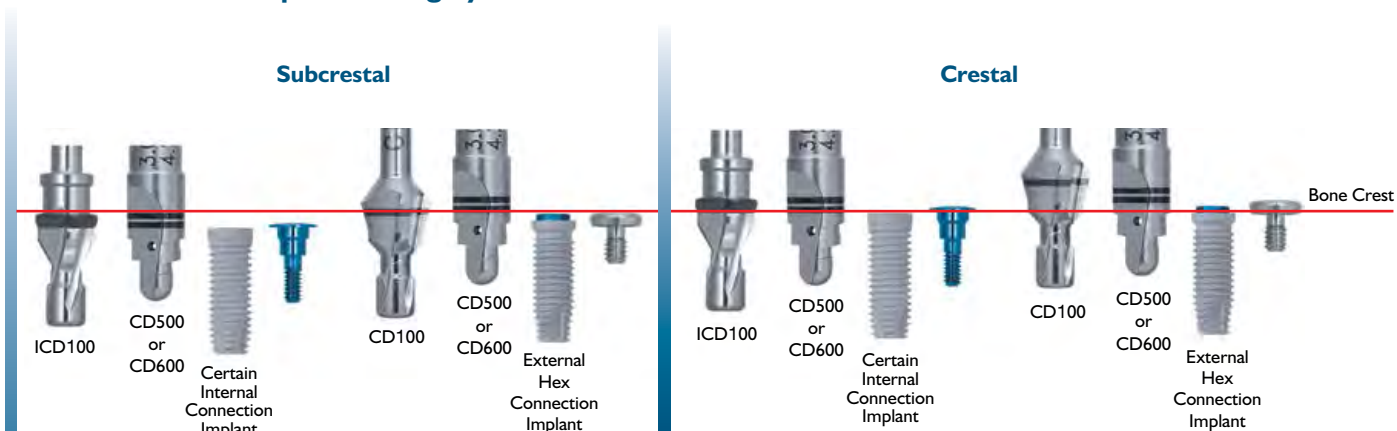

A Countersink Drill is used when placing 4, 5 and 6mm(D) Implants subcrestally to shape the crestal bone to accept the implant collar.

For crestal placement of the implant, a Countersink Drill may be needed in dense bone due to the shape of the implant collar.

Quick Reference Subcrestal Surgical Protocol

Certain® Internal & External Hex Connection Parallel Walled Implants

- The recommended drill speed for drills 3.85mm diameter or smaller is 1200 – 1500rpm.
- The recommended drill speed for drills 4.25mm diameter or larger is 900rpm.
- The implant placement torque may exceed 50Ncm.
- The recommended implant placement speed is 15 – 20rpm.
- Final Twist Drill selection is based on clinician evaluation of bone quality.
- Hand ratcheting may be necessary to fully seat the implant into the osteotomy.
- Certain Internal Connection Driver Tips should be inspected for wear before use.
- It is recommended that reusable drills be replaced after 15 uses.
- **Tapping is required for implant placement in dense bone (Type I) for parallel walled 5mm, 6mm, 5/4mm and 6/5mm diameter implants or when the insertion torque is more than 90Ncm.**

IMPORTANT NOTE: Exceeding insertion torque of more than 90Ncm may deform or strip the driver tip or the implant's internal hex and may possibly delay the surgical procedure.

ACT® Twist Drill Depth Marks

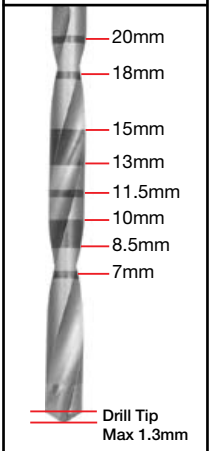

D = Diameter
L = Length

Parallel Walled 3.25mm(D) Implants

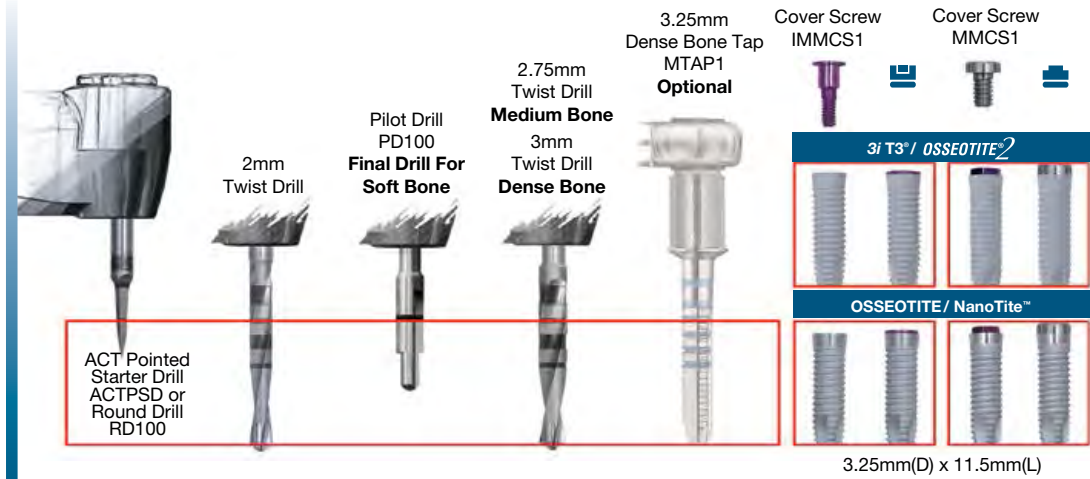

See page 46 for detailed instructions.

Parallel Walled 3.75mm(D) Implants

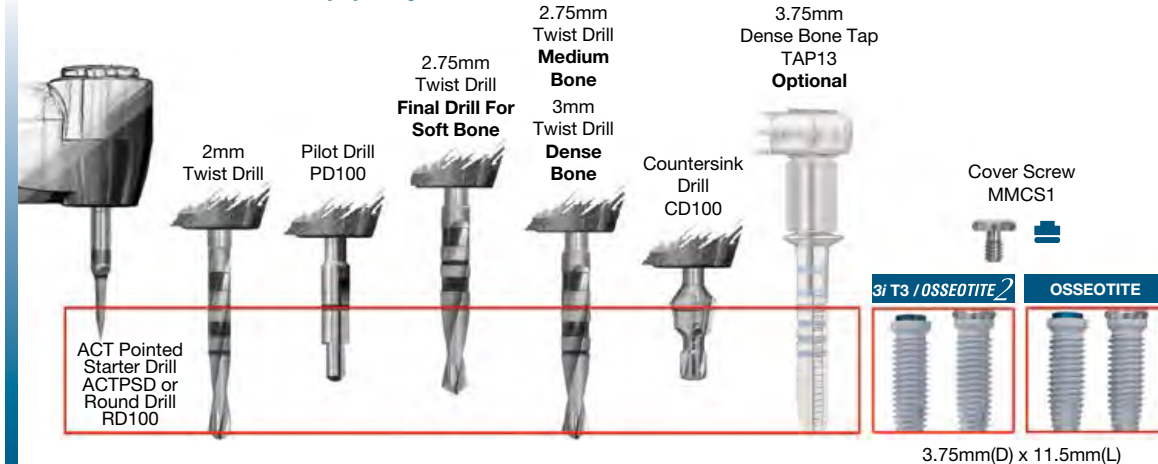

See page 48 for detailed instructions.

Quick Reference Subcrestal Surgical Protocol (Cont'd)

Certain® Internal & External Hex Connection Parallel Walled Implants

Parallel Walled Platform Switched 4mm(D) x 3.4mm(P) & 4mm(D) Implants

D = Diameter
P = Platform
L = Length

2.75mm Twist Drill **Soft Bone**
3mm Twist Drill **Medium Bone**
3.25mm Twist Drill **Dense Bone**

4mm Countersink Drill ICD100
4.1mm Countersink Drill CD100

ACT® Pointed Starter Drill
ACTPSD or Round Drill RD100

Certain Internal Connection External Connection

Cover Screw IMCSF34
4mm Dense Bone Tap TAP413
Optional

Cover Screw ICSF41
Cover Screw CS375

3i T3 / OSSEOTITE²
OSSEOTITE / NanoTite™

4mm(D) x 3.4mm(P) x 11.5mm(L) 4mm(D) x 11.5mm(L)

See page 50 for detailed instructions.

Parallel Walled Platform Switched 5mm(D) x 4.1mm(P) & 5mm(D) Implants

5mm Countersink Drill CD500
Final Drill For Soft Bone

3.85mm Twist Drill **Medium Bone**
4.25mm Twist Drill **Dense Bone**

5mm 3i T3 & OSSEOTITE² Dense Bone Tap XTAP53S
5mm OSSEOTITE Dense Bone Tap TAP53S

ACT Pointed Starter Drill
ACTPSD or Round Drill RD100

Certain Internal Connection External Connection

Cover Screw ICSF41
Cover Screw ICSF50
Cover Screw CS500

3i T3 / OSSEOTITE²
OSSEOTITE / NanoTite

5mm(D) x 4.1mm(P) x 11.5mm(L) 5mm(D) x 11.5mm(L)

Required for use in dense bone

See page 52 for detailed instructions.

Parallel Walled Platform Switched 6mm(D) x 5mm(P) & 6mm(D) Implants

6mm Countersink Drill CD600
Final Drill For Soft Bone

4.85mm Twist Drill **Medium Bone**
5.25mm Twist Drill **Dense Bone**

6mm 3i T3 & OSSEOTITE² Dense Bone Tap XTAP63S
6mm OSSEOTITE Dense Bone Tap TAP63S

ACT Pointed Starter Drill
ACTPSD or Round Drill RD100

Certain Internal Connection External Connection

Cover Screw ICSF50
Cover Screw ICSF60
Cover Screw CS600

3i T3 / OSSEOTITE²
OSSEOTITE / NanoTite

6mm(D) x 5mm(P) x 11.5mm(L) 6mm(D) x 11.5mm(L)

Required for use in dense bone

See page 54 for detailed instructions.

Subcrestal Surgical Protocol

Certain® Internal & External Hex Connection

Parallel Walled 3.25mm(D) Implants

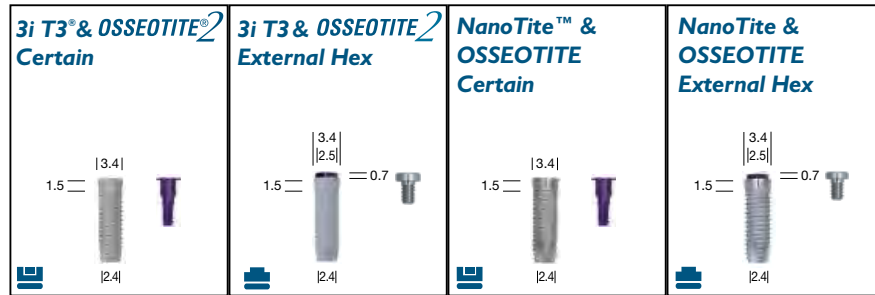

For a quick reference guide to implant placement, please refer to page 44.



1. Once the implant site has been determined, mark the site with the ACT® Pointed Starter Drill or Round Drill and penetrate the cortical bone to the depth mark of the drill. The recommended drill speed is 1200 – 1500rpm. Use copious irrigation with sterile water or saline solution to prevent overheating of the bone during high speed drilling.

- Instrument needed:
ACT Pointed Starter Drill (ACTPSD)
or
Round Drill (RD100 or DR100)

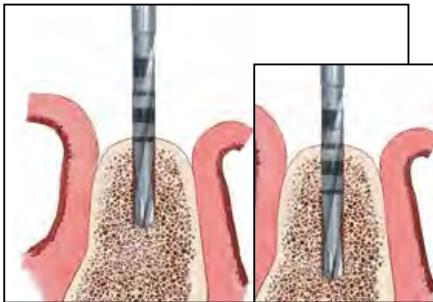

2. Proceed with the Initial Twist Drill to approximately 7mm, and then verify the direction with the narrow end of the Direction Indicator. Thread a suture through the hole to prevent accidental swallowing.

Continue to advance the drill into the osteotomy to the desired depth. The recommended drill speed is 1200 – 1500rpm.

- Instruments needed:
2mm Twist Drill
Direction Indicator (DI100 or DI2310)



3. Verify the direction and position of the preparation by inserting the narrow end of the Direction Indicator into the osteotomy. Thread a suture through the hole to prevent accidental swallowing.

At this step, a Gelb Radiographic Depth Gauge may also be used.

- Instruments needed:
Direction Indicator (DI100 or DI2310)
Gelb Radiographic Depth Gauge (XDGxx)

Subcrestal Surgical Protocol

Certain® Internal & External Hex Connection Parallel Walled 3.25mm(D) Implants (Cont'd)



4. Use the Pilot Drill to shape the coronal aspect of the implant site and to provide a starting point for the next diameter drill. Drill to the depth mark. The recommended drill speed is 1200 – 1500rpm.

For **soft bone (Type IV)**, this is the final drill. Proceed to **step 1** on **page 57** for implant placement.

- Instrument needed:
Pilot Drill (PD100 or DP100)



5. Once proper alignment is verified using the Direction Indicator, proceed with the 2.75mm Twist Drill to the desired depth for implant placement in medium bone (Type II and III). Proceed with the 3mm Twist Drill to the desired depth for implant placement in dense bone (Type I). The recommended drill speed is 1200 – 1500rpm.

- Instruments needed:
2.75mm Twist Drill for medium bone (Type II and III)
3mm Twist Drill for dense bone (Type I)

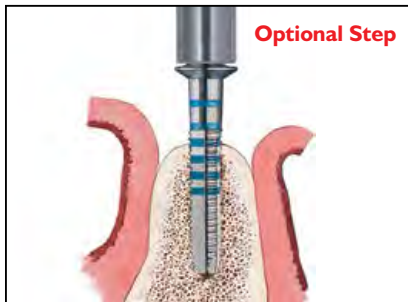

Optional Tapping Step: For dense bone (Type I) or when the insertion torque is more than 90Ncm.

If placing a 3.25mm(D) Implant in dense bone (Type I) or when the insertion torque is more than 90Ncm, tapping with a Dense Bone Tap is recommended.

Using the Handpiece Connector, advance the tap into the prepared site at approximately 15 – 20rpm. It is not uncommon for the drill unit to stall before the tap is completely seated. Final seating of the Dense Bone Tap may require the use of the Ratchet Extension and the Ratchet Wrench.

- Instruments needed:
Handpiece Connector (MDR10)
Bone Tap (MTAP1 or MTAP2)
Ratchet Wrench (WR150) or High Torque Indicating Ratchet Wrench (H-TIRW)
Ratchet Extension (RE100 or RE200)

Proceed to **step 1** on **page 57** for implant placement.

For more information on various **bone densities**, please see **page 7**.

Subcrestal Surgical Protocol

External Hex Connection

Parallel Walled 3.75mm(D) Implants

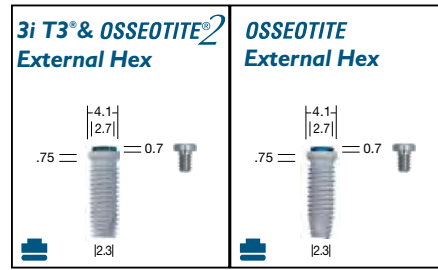

For a quick reference guide for 3.75mm(D) implant placement, please refer to page 44.



1. Once the implant site has been determined, mark the site with the ACT® Pointed Starter Drill or Round Drill and penetrate the cortical bone to the depth mark of the drill. The recommended drill speed is 1200 – 1500rpm. Use copious irrigation with sterile water or saline solution to prevent overheating of the bone during high speed drilling.

- Instrument needed:
ACT Pointed Starter Drill (ACTPSD)
or
Round Drill (RD100 or DR100)



2. Proceed with the Initial Twist Drill to approximately 7mm, and then verify the direction with the narrow end of the Direction Indicator. Thread a suture through the hole to prevent accidental swallowing.

Continue to advance the drill into the osteotomy to the desired depth. The recommended drill speed is 1200 – 1500rpm.

- Instruments needed:
2mm Twist Drill
Direction Indicator (DI100 or DI2310)



3. Verify the direction and position of the preparation by inserting the narrow end of the Direction Indicator into the osteotomy. Thread a suture through the hole to prevent accidental swallowing.

At this step, a Gelb Radiographic Depth Gauge may also be used.

- Instruments needed:
Direction Indicator (DI100 or DI2310)
Gelb Radiographic Depth Gauge (XDGxx)



4. Use the Pilot Drill to shape the coronal aspect of the implant site and to provide a starting point for the next diameter drill. Drill to the depth mark. The recommended drill speed is 1200 – 1500rpm.

- Instrument needed:
Pilot Drill (PD100 or DP100)

Subcrestal Surgical Protocol

External Hex Connection

Parallel Walled 3.75mm(D) Implants (Cont'd)



Final Twist Drill Step For A Parallel Walled 3.75mm(D) Implant In Soft Bone (Type IV)

In soft bone situations where dense cortical bone is present, it may be necessary to prepare the coronal aspect of the osteotomy.

- 5a.** After preparing the osteotomy with the PD100 Pilot Drill, proceed with the 2.75mm Twist Drill to the first depth mark (7mm).

Proceed to **step 6** for soft bone (Type IV).



Final Twist Drill Step For A Parallel Walled 3.75mm(D) Implant In Medium (Type II And Type III) To Dense Bone (Type I)

- 5b.** Once proper alignment is verified using the Direction Indicator, proceed with the 2.75mm Twist Drill to the desired depth for implant placement in medium bone (Type II and III). Proceed with the 3mm Twist Drill to the desired depth for implant placement in dense bone (Type I). The recommended drill speed is 1200 – 1500rpm.

- Instruments needed:
2.75mm Twist Drill for medium bone (Type II and III)
3mm Twist Drill for dense bone (Type I)



- 6.** Using the Countersink Drill, prepare the coronal aspect of the osteotomy to accept the 4.5mm flared cover screw of the 3.75mm(D) implant for subcrestal placement. Drill to the center of the depth mark for subcrestal placement. The recommended drill speed is 1200 – 1500rpm.

- Instrument needed:
Countersink Drill (CD100)

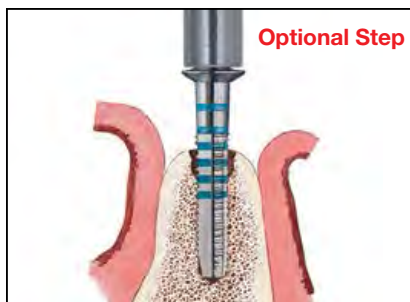

Optional Tapping Step: For dense bone (Type I) or when the insertion torque is more than 90Ncm.

If placing a 3.75mm(D) implant in dense bone (Type I) or when the insertion torque is more than 90Ncm, tapping with a Dense Bone Tap is recommended.

Using the Handpiece Connector, advance the tap into the prepared site at approximately 15 – 20rpm. It is not uncommon for the drill unit to stall before the tap is completely seated. Final seating of the tap may require the use of the Ratchet Extension and the Ratchet Wrench.

- Instruments needed:
Handpiece Connector (MDR10)
Dense Bone Tap - 3.75mm(D) (TAP10, TAP13 or TAP20)
Ratchet Wrench (WR150) or High Torque Indicating Ratchet Wrench (H-TIRW)
Ratchet Extension (RE100 or RE200)

Proceed to **step 1** on **page 57** for implant placement.

For more information on various **bone densities**, please see **page 7**.

Subcrestal Surgical Protocol

Certain® Internal & External Hex Connection

Parallel Walled Platform Switched 4mm(D) x 3.4mm(P) & 4mm(D) Implants

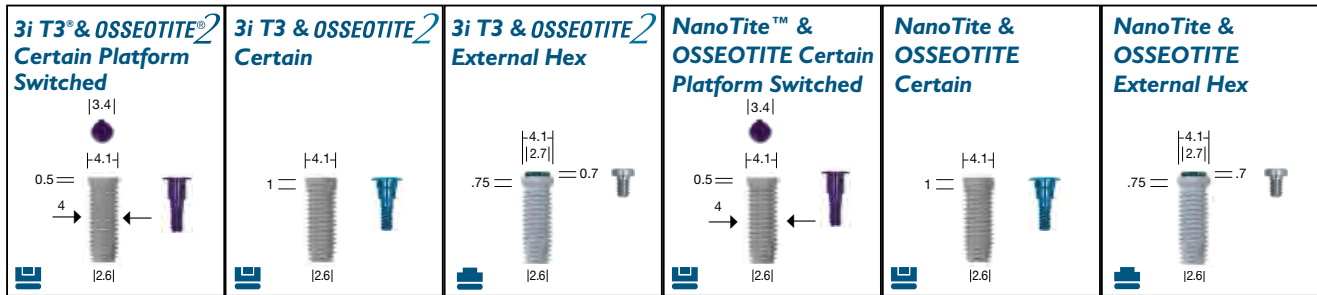

For a quick reference guide to implant placement, please refer to page 45.



- Once the implant site has been determined, mark the site with the ACT® Pointed Starter Drill or Round Drill and penetrate the cortical bone to the depth mark of the drill. The recommended drill speed is 1200 – 1500rpm. Use copious irrigation with sterile water or saline solution to prevent overheating of the bone during high speed drilling.
 - Instrument needed:
ACT Pointed Starter Drill (ACTPSD)
or
Round Drill (RD100 or DR100)



- Proceed with the initial Twist Drill to approximately 7mm, and then verify the direction with the narrow end of the Direction Indicator. Thread a suture through the hole to prevent accidental swallowing.

Continue to advance the drill into the osteotomy to the desired depth. The recommended drill speed is 1200 – 1500rpm.

- Instruments needed:
2mm Twist Drill
Direction Indicator (DI100 or DI2310)



- Verify the direction and position of the preparation by inserting the narrow end of the Direction Indicator into the osteotomy. Thread a suture through the hole to prevent accidental swallowing.

At this step, a Gelb Radiographic Depth Gauge may also be used.

- Instruments needed:
Direction Indicator (DI100 or DI2310)
Gelb Radiographic Depth Gauge (XDGxx)



- Use the Pilot Drill to shape the coronal aspect of the implant site and to provide a starting point for the next diameter drill. Drill to the depth mark. The recommended drill speed is 1200 – 1500rpm.

- Instrument needed:
Pilot Drill (PD100 or DP100)

Subcrestal Surgical Protocol

Certain® Internal & External Hex Connection

Parallel Walled Platform Switched 4mm(D) x 3.4mm(P) & 4mm(D) Implants (Cont'd)





5. Once proper alignment is verified using the Direction Indicator, proceed with the 2.75mm Twist Drill to the desired depth for implant placement in soft bone (Type IV). Proceed with the 3mm Twist Drill to the desired depth for implant placement in medium bone (Type II and III). Proceed with the 3.25mm Twist Drill for implant placement in dense bone (Type I). The recommended drill speed is 1200 – 1500rpm.

- Instruments needed:
 - 2.75mm Twist Drill for soft bone (Type IV)
 - 3mm Twist Drill for medium bone (Type II and III)
 - 3.25mm Twist Drill for dense bone (Type I)



6. Using the Countersink Drill, prepare the coronal aspect of the osteotomy to accept the 4mm(D) implant collar. Drill to the **top** edge of the depth mark for subcrestal placement of Certain Internal Connection Implants. Drill to the **center** of the depth mark for subcrestal placement of External Hex Connection Implants. The recommended drill speed is 1200 – 1500rpm.

- Instrument needed:
 -  Countersink Drill (ICD100)
 -  Countersink Drill (CD100)



Optional Tapping Step: For dense bone (Type I) or when the insertion torque is more than 90Ncm.

If placing a 4mm(D) x 3.4mm(P) or 4mm(D) Implant in dense bone (Type I) or when the insertion torque is more than 90Ncm, tapping with a Dense Bone Tap is recommended.

Using the Handpiece Connector, advance the tap into the prepared site at approximately 15 – 20rpm. It is not uncommon for the drill unit to stall before the tap is completely seated. Final seating of the Dense Bone Tap may require the use of the Ratchet Extension and the Ratchet Wrench.

- Instruments needed:
 - Handpiece Connector (MDR10)
 - Bone Tap (TAP410, TAP413 or TAP420)
 - Ratchet Wrench (WR150) or High Torque Indicating Ratchet Wrench (H-TIRW)
 - Ratchet Extension (RE100 or RE200)

Proceed to **step 1** on **page 57** for implant placement.

For more information on various **bone densities**, please see **page 7**.

Subcrestal Surgical Protocol

Certain® Internal & External Hex Connection

Parallel Walled Platform Switched 5mm(D) x 4.1mm(P) & 5mm(D) Implants

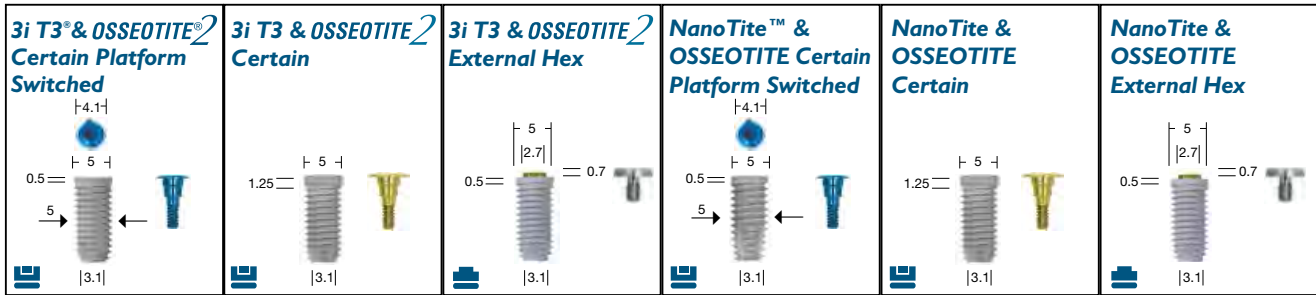

For a quick reference guide to implant placement, please refer to page 45.



- Once the implant site has been determined, mark the site with the ACT® Pointed Starter Drill or Round Drill and penetrate the cortical bone to the depth mark of the drill. The recommended drill speed is 1200 – 1500rpm. Use copious irrigation with sterile water or saline solution to prevent overheating of the bone during high speed drilling.
 - Instrument needed:
ACT Pointed Starter Drill (ACTPSD)
or
Round Drill (RD100 or DR100)



- Proceed with the initial Twist Drill to approximately 7mm, and then verify the direction with the narrow end of the Direction Indicator. Thread a suture through the hole to prevent accidental swallowing.

Continue to advance the drill into the osteotomy to the desired depth. The recommended drill speed is 1200 – 1500rpm.

- Instruments needed:
2mm Twist Drill
Direction Indicator (DI100 or DI2310)



- Verify the direction and position of the preparation by inserting the narrow end of the Direction Indicator into the osteotomy. Thread a suture through the hole to prevent accidental swallowing.

At this step, a Gelb Radiographic Depth Gauge may also be used.

- Instruments needed:
Direction Indicator (DI100 or DI2310)
Gelb Radiographic Depth Gauge (XDGxx)



- Use the Pilot Drill to shape the coronal aspect of the implant site and to provide a starting point for the next diameter drill. Drill to the depth mark. The recommended drill speed is 1200 – 1500rpm.

- Instrument needed:
Pilot Drill (PD100 or DP100)

Subcrestal Surgical Protocol

Certain® Internal & External Hex Connection

Parallel Walled Platform Switched 5mm(D) x 4.1mm(P) & 5mm(D) Implants (Cont'd)



5. Once proper alignment is verified using the Direction Indicator, proceed with the 3.25mm Twist Drill to the desired depth. The recommended drill speed is 1200 – 1500rpm.

- Instrument needed:
3.25mm Twist Drill



6. Use the 5mm(D) Countersink/Pilot Drill to shape the coronal aspect of the implant site. For subcrestal placement of a Certain Internal Connection Implant, drill to the top edge of the **top** depth mark. For subcrestal placement of an External Hex Connection Implant, drill to the center of the **bottom** depth mark. The recommended drill speed is 900rpm.

- Instrument needed:
5mm Countersink/Pilot Drill (CD500)

For **soft bone (Type IV)**, this is the final drill. Proceed to **step 1** on **page 57** for implant placement.



7. Once the coronal aspect of the osteotomy has been prepared, proceed with the 3.85mm Twist Drill to the desired depth for implant placement in medium bone (Type II and III). Proceed with the 4.25mm Twist Drill to the desired depth for implant placement in dense bone (Type I). The recommended drill speed is 900rpm.

- Instruments needed:
3.85mm Twist Drill for medium bone (Type II and III)
4.25mm Twist Drill for dense bone (Type I)

Required Tapping Step: For dense bone (Type I) or when the insertion torque is more than 90Ncm.

If placing a 5mm(D) x 4.1mm(P) or 5mm(D) implant in dense bone (Type I) or when the insertion torque is more than 90Ncm, tapping with a Dense Bone Tap is recommended.

Using the Handpiece Connector, advance the tap into the prepared site at approximately 15 – 20rpm. It is not uncommon for the drill unit to stall before the tap is completely seated. Final seating of the Dense Bone Tap may require the use of the Ratchet Extension and the Ratchet Wrench.

- Instruments needed:
Handpiece Connector (MDR10)
Bone Tap (XTAP58S, XTAP53S or XTAP518S)
Ratchet Wrench (WR150) or High Torque Indicating Ratchet Wrench (H-TIRW)
Ratchet Extension (RE100 or RE200)

Proceed to **step 1** on **page 57** for implant placement.

For more information on various **bone densities**, please see **page 7**.



OSSEOTITE²

Parallel Walled
Implants except for
OSSEOTITE²

Subcrestal Surgical Protocol

Certain® Internal & External Hex Connection

Parallel Walled Platform Switched 6mm(D) x 5mm(P) & 6mm(D) Implants

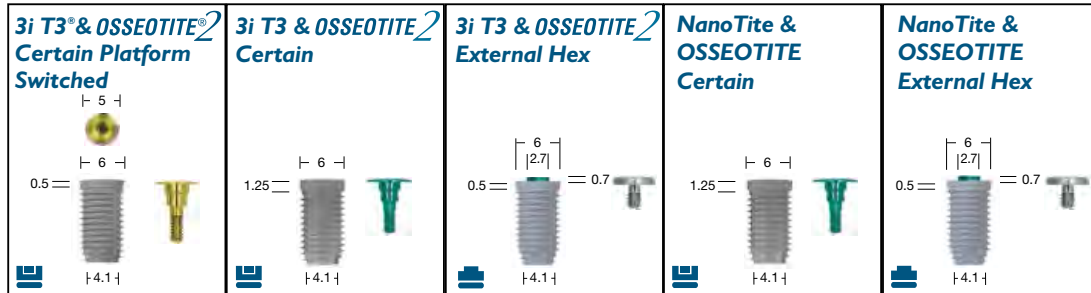

For a quick reference guide to implant placement, please refer to page 45.

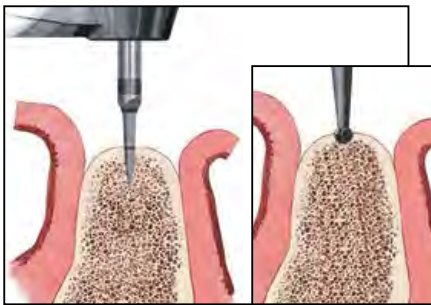

1. Once the implant site has been determined, mark the site with the ACT® Pointed Starter Drill or Round Drill and penetrate the cortical bone to the depth mark of the drill. The recommended drill speed is 1200 – 1500rpm. Use copious irrigation with sterile water or saline solution to prevent overheating of the bone during high speed drilling.

- Instrument needed:
ACT Pointed Starter Drill (ACTPSD)
or
Round Drill (RD100 or DR100)



2. Proceed with the initial Twist Drill to approximately 7mm, and then verify the direction with the narrow end of the Direction Indicator. Thread a suture through the hole to prevent accidental swallowing.

Continue to advance the drill into the osteotomy to the desired depth. The recommended drill speed is 1200 – 1500rpm.

- Instruments needed:
2mm Twist Drill
Direction Indicator (DI100 or DI2310)



3. Verify the direction and position of the preparation by inserting the narrow end of the Direction Indicator into the osteotomy. Thread a suture through the hole to prevent accidental swallowing.

At this step, a Gelb Radiographic Depth Gauge may also be used.

- Instruments needed:
Direction Indicator (DI100 or DI2310)
Gelb Radiographic Depth Gauge (XDGxx)

Subcrestal Surgical Protocol

Certain® Internal & External Hex Connection

Parallel Walled Platform Switched 6mm(D) x 5mm(P) & 6mm(D) Implants (Cont'd)



4. Use the Pilot Drill to shape the coronal aspect of the implant site and to provide a starting point for the next diameter drill. Drill to the depth mark. The recommended drill speed is 1200 – 1500rpm.

- Instrument needed:
Pilot Drill (PD100 or DP100)



5. Once proper alignment is verified using the Direction Indicator, proceed with the 3.25mm Twist Drill to the desired depth. The recommended drill speed is 1200 – 1500rpm.

- Instrument needed:
3.25mm Twist Drill



6. Advance the 5mm Countersink/Pilot Drill to the center of the **top** depth mark to widen the coronal aspect of the osteotomy, allowing the 4.25mm Twist Drill to enter the osteotomy. The recommended drill speed is 900 – 1200rpm.

- Instrument needed:
5mm Countersink/Pilot Drill (CD500)



7. Once the coronal aspect of the osteotomy has been prepared, proceed with the 4.25mm Twist Drill to the desired depth. The recommended drill speed is 900 – 1200rpm.

- Instrument needed:
4.25mm Twist Drill

Subcrestal Surgical Protocol

Certain® Internal & External Hex Connection

Parallel Walled Platform Switched 6mm(D) x 5mm(P) & 6mm(D) Implants (Cont'd)

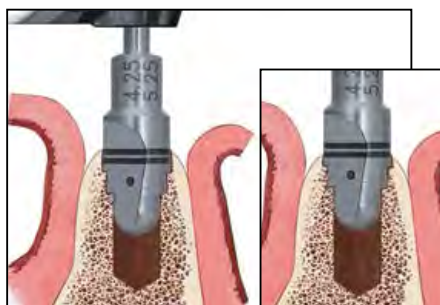

- Use the 6mm(D) Countersink/Pilot Drill to shape the coronal aspect of the implant site. For subcrestal placement of a Certain Internal Connection Implant, drill to the top edge of the **top** depth mark. For subcrestal placement of an External Hex Connection Implant, drill to the center of the **bottom** depth mark. The recommended drill speed is 900 – 1200rpm.

- Instrument needed:
6mm Countersink/Pilot Drill (CD600)

For **soft bone (Type IV)**, this is the final drill. Proceed to **step 1** on **page 57** for implant placement.



- Once the coronal aspect of the osteotomy has been prepared, proceed with the 4.85mm Twist Drill to the desired depth for implant placement in medium bone (Type II and Type III). Proceed with the 5.25mm Twist Drill to the desired depth for implant placement in dense bone (Type I). The recommended drill speed is 900rpm.

- Instruments needed:
4.85mm Twist Drill for medium bone (Type II and III)
5.25mm Twist Drill for dense bone (Type I)

Proceed to **step 1** on **page 57** for implant placement.



OSSEOTITE²

**Parallel Walled
Implants except for
OSSEOTITE²**

Required Tapping Step: For dense bone (Type I) or when the insertion torque is more than 90Ncm.

If placing a 6mm(D) x 5mm(P) or 6mm(D) Implant in dense bone (Type I) or when the insertion torque is more than 90Ncm, tapping with a Dense Bone Tap is required.

Using the Handpiece Connector, advance the tap into the prepared site at approximately 15 – 20rpm. It is not uncommon for the drill unit to stall before the tap is completely seated. Final seating of the Dense Bone Tap may require the use of the Ratchet Extension and the Ratchet Wrench.

- Instruments needed:
Handpiece Connector (MDR10)
Bone Tap (XTAP68S, XTAP63S or XTAP618S)
Ratchet Wrench (WR150) or High Torque Indicating Ratchet Wrench (H-TIRW)
Ratchet Extension (RE100 or RE200)

Proceed to **step 1** on **page 57** for implant placement.

For more information on various **bone densities**, please see **page 7**.

Subcrestal Implant Placement Protocol

Certain® Internal & External Hex Connection Parallel Walled Implants



No-Touch™ Delivery System

1.  Remove contents from the implant box.

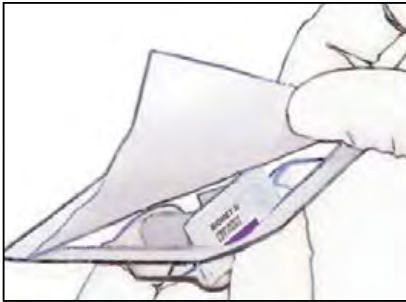

2.  The nonsterile assistant should peel back the tray lid and drop the No-Touch Implant Tray onto the sterile drape.



3.  Wearing sterile gloves, place the No-Touch Implant Tray into the appropriate location on the surgical tray.



4.  Peel back the tray lid to expose the implant and cover screw.

Subcrestal Implant Placement Protocol (Cont'd)

Certain® Internal & External Hex Connection

Parallel Walled Implants



Instructions Specific To A Certain Parallel Walled Platform Switched 4mm(D) x 3.4mm(P) And 3.25mm(D) Implant

5.  For the Certain Internal Connection Implant, pick up the implant from the surgical tray using the dedicated Certain Implant Placement Driver Tip. Carry the implant to the mouth facing upward to prevent accidental dislodging. Due to wear, periodic o-ring replacement is required for the Certain Internal Connection Driver Tip. Certain Internal Connection Driver Tips should be inspected for wear before use. See page 64 for additional technical tips.

- Instrument needed for 4mm(D) x 3.4mm(P) and 3.25mm(D) Implants:
Dedicated Certain 3.25mm(D) Driver Tip (IMPPTS or IMPDTL)

NOTE: The Certain Parallel Walled 4mm(D) x 3.4mm(P) and 3.25mm(D) Implants require the use of a dedicated Certain 3.4mm(D) Driver Tip (IMPPTS or IMPDTL) that is marked with a purple band on the shank. The internal connection configuration is smaller than the Certain 4, 5 and 6mm(D) Standard Implants. The item numbers can be identified on the side of the driver tip.

Proceed to **step 6** on **page 59**.

Or

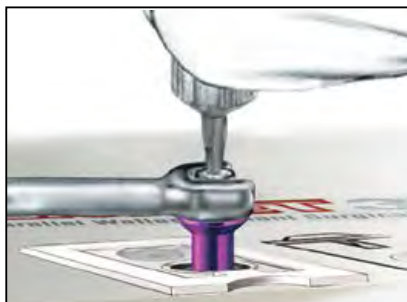

Instructions Specific To An External Hex Parallel Walled 3.25mm(D) Implant

5.  For the External Hex Connection Implant, pick up the implant mount from the surgical kit using the Open End Wrench. Place the mount onto the implant. Once placed on the implant, hand-tighten the mount screw using the large hex driver. Pick up the implant from the surgical tray using the Handpiece Connector. Carry the implant to the mouth facing upward to prevent accidental dislodging.

- Instruments needed:
 - Open End Wrench (CW100)
 - Large Hex Driver (PHD02N)
 - Implant Mount (MMC03 or MMC15)
 - Handpiece Connector (MDR10)

Proceed to **step 6** on **page 59**.



Subcrestal Implant Placement Protocol (Cont'd)

Certain® Internal & External Hex Connection

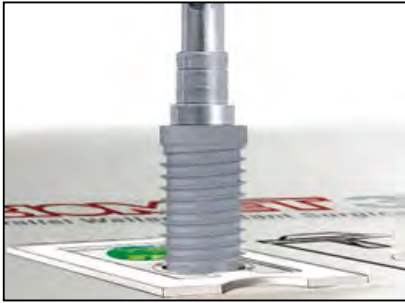
Parallel Walled Implants



Instructions Specific To A Certain Parallel Walled 4mm(D) Or Larger Implant

5.   For the Certain Internal Connection Implant, pick up the implant from the surgical tray using the dedicated Certain Implant Placement Driver Tip. Carry the implant to the mouth facing upward to prevent accidental dislodging. Due to wear, periodic o-ring replacement is required for the Certain Internal Connection Driver Tip. Certain Internal Connection Driver Tips should be inspected for wear before use. See page 64 for additional technical tips.

- Instrument needed for 5mm(D) x 4.1mm(P), 6mm(D) x 5mm(P) and 4, 5 and 6mm(D) Implants:

Dedicated Certain Standard Driver Tip (IIPDTS or IIPDTL)

Or

Instructions Specific To An External Hex Parallel Walled 3.75mm(D) Or Larger Implant



-   For the External Hex Connection Implant, pick up the implant from the surgical tray using the Handpiece Connector.

- Instrument needed:
Handpiece Connector (MDR10)



Optional Step For External Hex Implant Placement Between Or Adjacent To Teeth:

Remove the pre-attached mount and replace with the standard (long) mount from the surgical kit for 3.75, 4, 5 and 6mm(D) Implants. Fully seat the mount and hand-tighten the mount screw using the hex driver.



6.   Place the implant in the prepared site at approximately 15 – 20rpm. It is not uncommon for the handpiece to stall before the implant is completely seated. In dense bone (Type I), tapping is required prior to placement of a 5mm(D) x 4.1mm(P), 6mm(D) x 5mm(P) and 5 and 6mm(D) Implants and is optional for 4mm(D) x 3.4mm(P), 3.25, 3.75 and 4mm(D) Implants.



7.   Final seating of the implant may require the use of the Ratchet Wrench and Certain Ratchet Extension.

- Instruments needed:
Ratchet Wrench (WR150) or High Torque Indicating Ratchet Wrench (H-TIRW)
Certain Ratchet Extension (IRE100U or IRE200U) or 3.4mm(D) Ratchet Extension (IMRE100 or IMRE200)
External Hex Connection Ratchet Extension (RE100 or RE200)





Subcrestal Implant Placement Protocol (Cont'd)

Certain® Internal & External Hex Connection

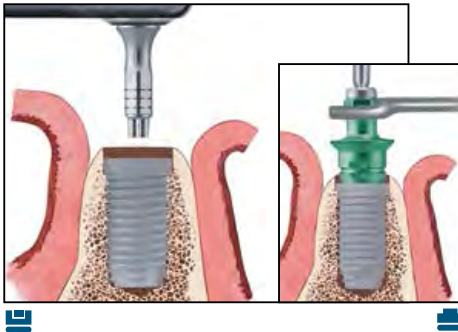
Parallel Walled Implants



8.  To remove the Certain Ratchet Extension from the implant, lift straight up and out.
-  To remove the implant mount, place the Open End Wrench onto the mount. Loosen the screw at the top of the mount with a Large Hex Driver or the Large Hex Driver Tip inserted into the Right-Angle Driver and rotate counter-clockwise. After the screw is completely loosened, rotate the Open End Wrench counter-clockwise slightly, remove the Mount Driver Tip and Open End Wrench at the same time.

- Instruments needed:
Open End Wrench (CW100), Large Hex Driver Tip (RASH3) and Right-Angle Driver (CATDB with CADD1) or Large Hex Driver (PHD02N)

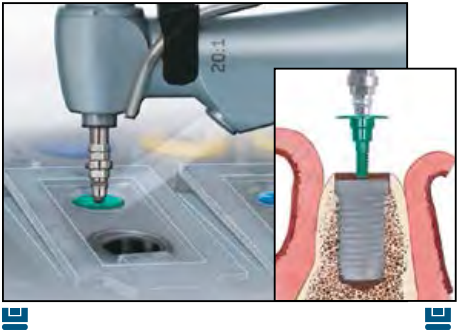



9.  If performing a two-stage surgical protocol, pick up the Cover Screw from the No-Touch™ Implant Tray with the Implant Placement Driver Tip or Large Hex Driver and place it onto the implant.

NOTE: When using the Certain Implant Placement Driver, reduce the torque setting on the drill unit to 10Ncm. Tighten the cover screw to 10Ncm.

- Instruments needed:
Implant Placement Driver Tip (IIPDTS or IIPDTL)
Large Hex Driver (PHD02N)

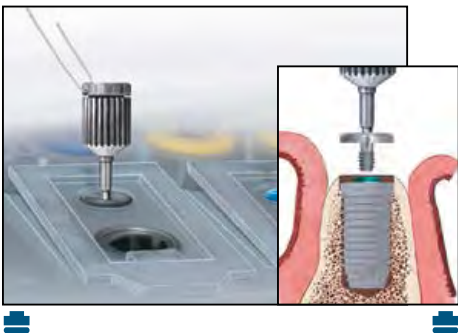
Or



-  If performing a two-stage surgical protocol, pick up the Cover Screw from the No-Touch Implant Tray with the Small Hex Driver (PHD00N) and place it onto the implant. Thread a suture through the hole to prevent accidental swallowing. Tighten the cover screw to 10Ncm.

NOTE: At this step, a temporary healing abutment may be placed in lieu of a cover screw when performing a single-stage surgical protocol. Tighten the healing abutment to 20Ncm.

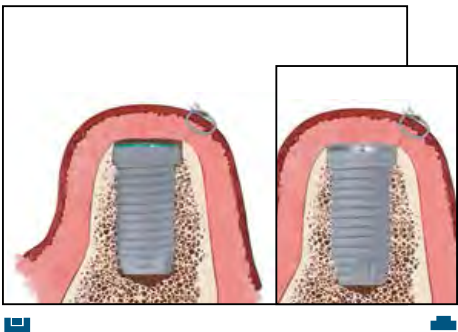

10.  Reposition the soft-tissue flaps and secure with sutures.

Surgical Indexing

Certain® Internal & External Hex Connection Tapered & Parallel Walled Implants



Surgeon

1. For surgical implant placement of a BIOMET 3i Implant, follow the normal protocol as described in the previous sections.



Surgical Indexing

2. A surgical index may be made at stage one or stage two surgery to facilitate the fabrication of a provisional restoration. This can be accomplished by using a Pick-Up Impression Coping (or a Hexed Temporary Cylinder) with retention, a waxing screw and medium-to-heavy body impression material.

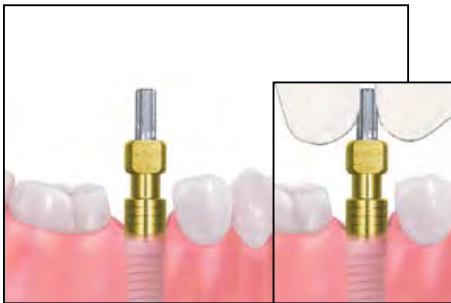

Creating A Surgical Index

3. Select the proper Pick-Up Impression Coping by matching it with the implant diameter platform.

Certain Internal Connection Implants			
Diameter Platform			
4/3mm 3.25mm	5/4mm 4mm	6/5mm 5mm	6mm
3.4mm	4.1mm	5mm	6mm

External Hex Connection Implants				
Diameter Platform				
3.25mm	3.75mm	4mm	5mm	6mm
3.4mm	4.1mm	4.1mm	5mm	6mm

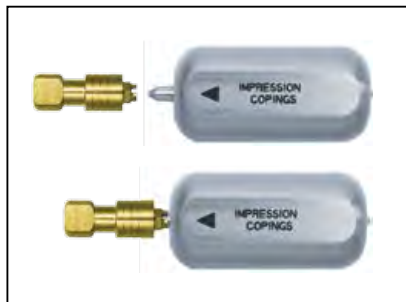

- Activate the fingers using the QuickSeat® Activator Tool. Place the Pick-Up Impression Coping or the Temporary Cylinder into the implant, line up the hex and press firmly until feeling a tactile click.

Or

- Place the Pick-Up Impression Coping or the Temporary Cylinder on the implant and engage the hex.

- Thread the Pick-Up Impression Coping Screw or Waxing Screw into the implant until finger tight. Tighten the screw using the Large Hex Driver. If the Impression Coping touches the adjacent teeth, the Impression Coping may need to be modified with a bur or disc.

Surgical Indexing (Cont'd)

Certain® Internal & External Hex Connection Tapered & Parallel Walled Implants

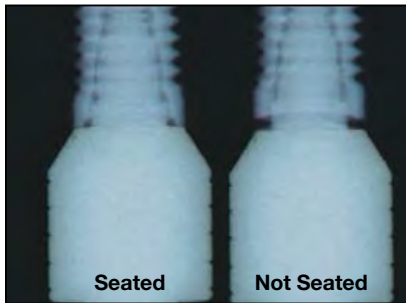

4.  If flapless surgery is performed or when the index is made at stage two surgery, take a radiograph of the interface to verify complete seating of the coping on the implant. Place the film or digital sensor perpendicular to the interface of the coping on the implant.

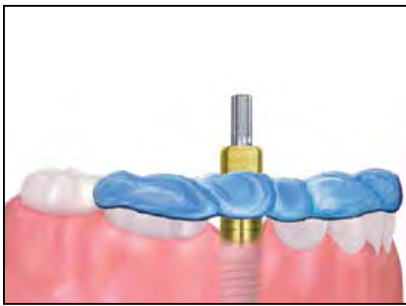

5.  Syringe a medium-to-heavy body impression material around the impression coping or temporary cylinder and over the occlusal surfaces of the adjacent teeth (approximately 1.5 teeth on either side). Allow the impression material to set per the manufacturer's instructions. Once the material has set, remove the impression coping screw or waxing screw using the Large Hex Driver. Remove the surgical index from the mouth. Send the index to the restorative clinician so that it may be included in the package to the laboratory. Do not place a lab analog into the index.



6.  Select a healing abutment by matching the implant platform, preferred emergence profile diameter and collar height. The collar height should be selected by measuring from the implant platform to the highest crest of the gingival tissue and adding 1mm.

Single Stage Treatment Protocol

Certain® Internal & External Hex Connection Tapered & Parallel Walled Implants

There may be several advantages to utilizing a two-stage implant system in a single-stage treatment protocol. Attaching a one-piece or two-piece healing abutment immediately following implant placement eliminates the need for a second-stage surgery. Eliminating the second surgical procedure reduces trauma and decreases treatment time, while the two-stage implant design maintains restorative flexibility.

NOTE: Tapered Implants are illustrated below. These instructions are also to be followed when using Parallel Walled Implants.

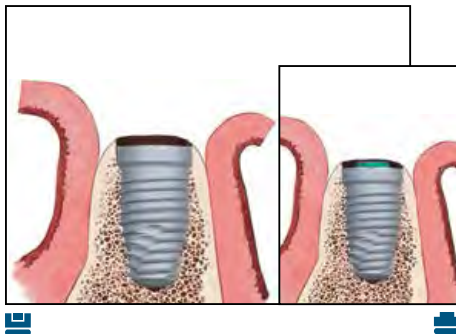

1. Fully seat the implant. If using an External Hex Connection Implant, remove the implant mount.

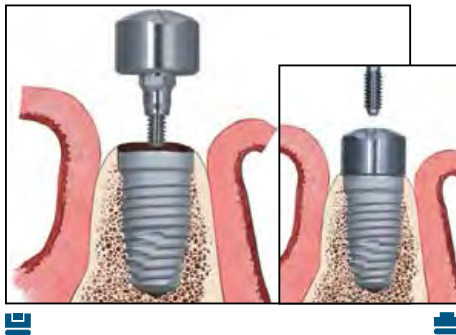

2. Select the appropriate one-piece healing abutment or *BellaTek*® Encode® Healing Abutment depending upon the implant seating surface, tissue depth and desired emergence profile dimension.

Bone profiling of the osteotomy may be necessary to fully seat the healing abutment onto the implant. See **page 67** for **bone profiling instructions**.

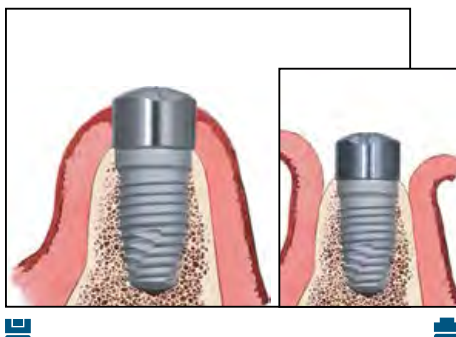

3. Tighten the one or two-piece healing abutment screw to 20Ncm and secure the soft-tissue flaps around it with intermittent sutures.

Mountless Delivery Protocol

Certain® Internal & External Hex Connection

Tapered & Parallel Walled Implants

NOTE: Tapered Implants are illustrated below. These instructions are also to be followed when using Parallel Walled Implants.

Pick-Up And Delivery Of Implant

Care must be taken when inserting the Implant Placement Driver Tip into the implant. A very low RPM must be used as you approach the internal connection of the implant with the driver tip to properly align the internal hex of the implant with the external hex of the driver. Press down firmly to engage the implant securely.

NOTE: The Certain® Platform Switched 4mm(D) x 3.4mm(P) and 3.25mm(D) Implants require the use of a dedicated Certain 3.4mm(D) Driver Tip (IMPPTS or IMPDTL) that is marked with a purple band on the shank. The internal connection configuration of these implants is smaller than the Certain 4mm(D), 5mm(D) and 6mm(D) Implants. The item numbers can be identified on the side of the driver tip.

Pick-Up And Delivery Of Cover Screw Or Healing Abutment

The 0.048 inch tip of the Certain Implant Placement Driver Tip can be used to pick up and place the cover screw or the healing abutment.

NOTE: When using the Certain Internal Connection Implant Driver (IIPDTS or IIPDTL) to place a cover screw or healing abutment, reduce the torque setting on the drilling unit to 10Ncm. Tighten the cover screw to 10Ncm.

The cover screw replica portion of the driver allows for visual verification of the standard 1mm cover screw position, making subcrestal and crestal placement of the implant predictable.

NOTE: Periodic o-ring replacement is required for the Certain Internal Connection Driver Tips. Certain Internal Connection Driver Tips should be inspected for wear before use.

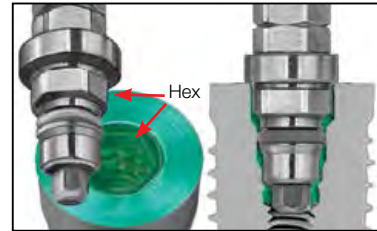

Implant And Driver Hex Design

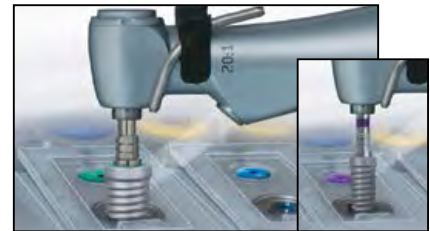

Implant Pick-Up

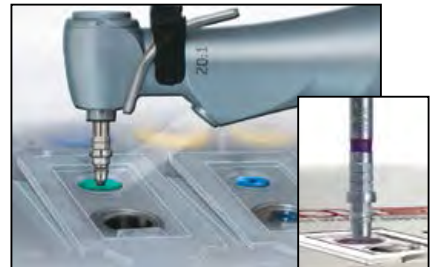

Cover Screw Pick-Up

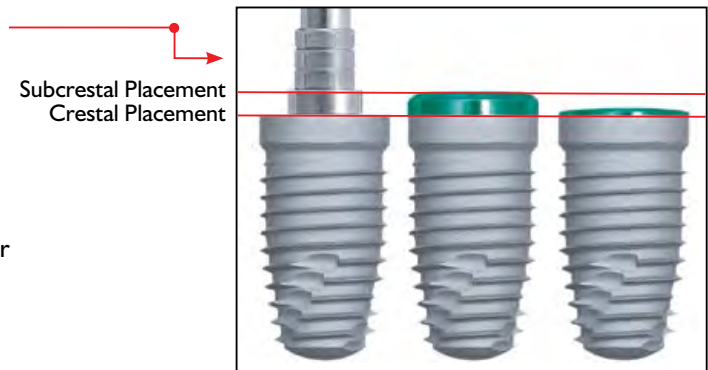

Subcrestal Placement
Crestal Placement

Implant Placement In Dense Bone

Certain® Internal & External Hex Connection

Tapered Implants Only

The specifications of the BIOMET **3i** Tapered Implant and the corresponding Quad Shaping Drills (QSDs) and Depth and Direction Indicators (NTDIs) are held to rigorous tolerances, which are intended to provide a closely integrated implant-to-osteotomy fit and primary stability. Because of the precise implant-to-osteotomy fit, the Tapered Implant may require reasonably higher levels of insertion torque (*cutting torque resistance* — the resistance created by the implant threads cutting a path into the osteotomy walls) to seat completely within the osteotomy. Higher torque may be equated with higher primary stability and hand ratcheting the implant

to the final position may be required. Therefore, when placing a Tapered Implant, the insertion torque required to fully seat the implant may exceed the maximum torque capable of being delivered by an implant drill unit (typically 50Ncm) and the need to tap the osteotomy may occur, such as in dense bone (Type I) or when the insertion torque is more than 90Ncm. More importantly, tapping (pre-threading) the osteotomy wall reduces cutting torque resistance so that the implant can be placed more passively while still maintaining a precise implant-to-osteotomy fit.

Preparation Of An Osteotomy In Dense Bone

The QSDs for placement of BIOMET **3i** Tapered Implants are designed to prepare the osteotomy to match the dimension of the minor diameter of the Tapered Implant (i.e. the implant body without the threads). The Tapered Implant NTDI is also precisely matched to the minor diameter of the implant. Therefore, in order to verify the accuracy of the desired placement (bucco-lingually, mesio-distally and apico-occlusally), the NTDI should be placed into the prepared site after irrigating and suctioning bone debris from the osteotomy. Thread a suture through the hole to prevent accidental swallowing. The NTDI should fit smoothly and cleanly (without binding or snapping) to the exact depth of the preparation, mimicking the final position of the implant. Should the NTDI not seat to the desired depth of the final seating position of the implant, it is likely because the drill was not advanced to the appropriate depth landmark on the QSD or the site was inadvertently ledged (subcrestal, crestal or supracrestal). If this occurs, additional drilling may be necessary to achieve the desired position using the QSD depth landmark as guidance. When Tapered Implants are placed subcrestally, care should be taken to ensure that residual supracrestal bone does not interfere with complete seating of the implant (Figures 1a and 1b). Adjustment of the supracrestal bone may be required as illustrated in Figure 2a. After adjustment, the fit of the NTDI should be verified (Figure 2b). Figures 3a and 3b demonstrate excessive supracrestal bone and the appropriate adjustment performed to permit a smooth and passive fit of the NTDI.

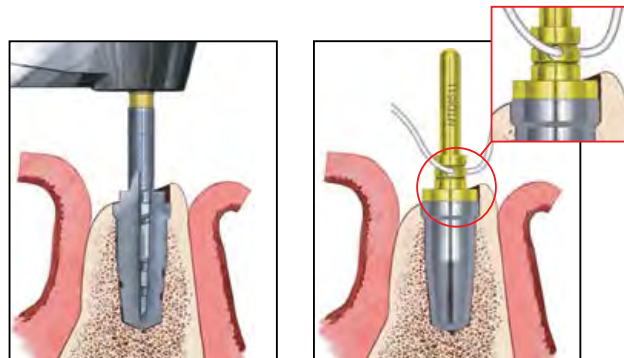

Figure 1a

Figure 1b

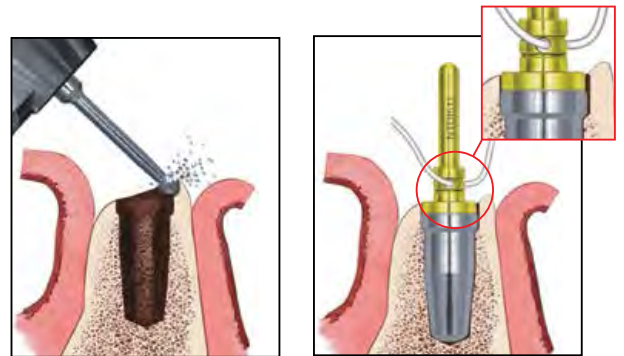

Figure 2a

Figure 2b

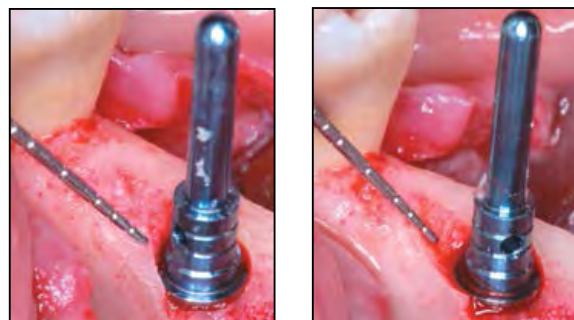

Figure 3a

Figure 3b

Implant Placement In Dense Bone (Cont'd)

Certain® Internal & External Hex Connection

Tapered & Parallel Walled Implants

Using Dense Bone Taps

In dense bone (Type I) or when the insertion torque is more than 90Ncm, it is often necessary to tap the osteotomy in order to fully seat the implant and reduce insertion torque. If tapping is not performed, deformation of the external hex of the implant or implant placement mount may occur. Dense Bone Taps should be advanced into the prepared osteotomy with the drilling unit set to 50Ncm and 15 – 20rpm. It is not unusual for the handpiece to stop prior to the tap reaching the full depth of the osteotomy. Therefore, a hand ratchet should be used to complete the tapping process (Figure 4).

Clinical Tip: A thumb or forefinger should be placed on top of the Ratchet Wrench with light downward pressure applied (Figure 5). This helps ensure continued full engagement of the mount and prevents implant wobble during insertion and assists in keeping the orientation in the proper plane.

Lavage Of The Osteotomy

Bone debris remaining in the osteotomy after site preparation with the drills or taps should be removed by irrigation with sterile water or saline and suction (Figure 6), as debris in the site may increase cutting torque resistance during tapping and implant placement, or prevent the implant from fully seating.

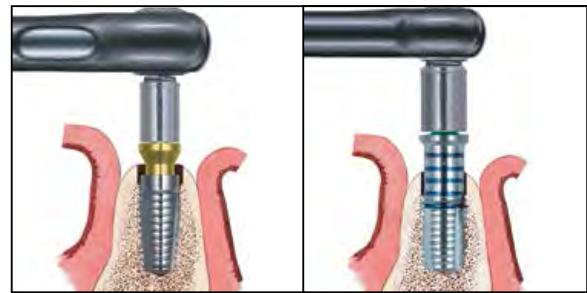

Figure 4

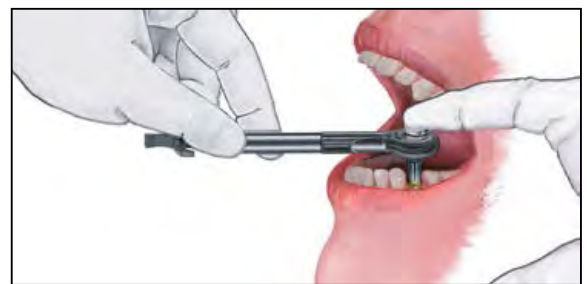

Figure 5



Figure 6

Bone Profiling

Certain® Internal & External Hex Connection Tapered & Parallel Walled Implants

Emergence Profile (EP®) Bone Profilers

Corresponding EP Bone Profilers are available to contour the bone that is to receive an EP Healing Abutment. This is especially helpful in a single-stage surgical protocol when the implant is placed subcrestally. Internal Connection Bone Profiling Pins are available for Certain Internal Connection Implants.

If the implant is placed subcrestally and use of an EP or *BellaTek* Encode® Healing Abutment is indicated, the coronal aspect of the osteotomy must be prepared to receive the flare of the healing abutment.



EP Bone Profilers correspond to the sizes of EP Healing Abutments

NOTE: Non-EP, straight healing abutments and impression copings are available if bone profiling is not preferred at either stage one or stage two surgery.

Internal Connection Two-Piece Bone Profiling Pin (IBPGP)

The internal connection implant requires a dedicated Bone Profiling Pin, which is used with EP Bone Profilers. This two-piece design allows the pin to engage the internal connection of the implant. The hex engagement prevents the pin from tightening into the implant during profiling, making it easy to remove. **Lubricating the top of the pin with an appropriate lubricant, such as tetracycline ointment, is recommended. Do not exceed 50rpm when using Bone Profilers.**



Internal Connection
Two-Piece
Bone Profiler Pin



External Hex Connection
One-Piece
Bone Profiler Pin

Bone Profiling Technique

- EP Bone Profiler slides over the Bone Profiler Pin.



- EP Bone Profiler creates a flare in the crest of bone.



- Flare of EP Abutment matches the flare of the corresponding EP Bone Profiler.



- EP Healing Abutment seated properly onto the implant in subcrestal placement.



Want A Broad Range Of Implant Solutions? We Have The Solution!

VISIT
www.biomet3i.com

For More Information, Please Contact Your Local BIOMET 3i Sales Representative



BIOMET 3i
4555 Riverside Drive
Palm Beach Gardens, FL 33410
1-800-342-5454
Outside The U.S.: +1-561-776-6700
Fax: +1-561-776-1272
www.biomet3i.com



BIOMET 3i
Dental Iberica S.L.
WTC Almeda Park, Ed. 1, Planta 1ª
Pl. de la Pau, s/n
08940, Cornellà de Llobregat
(Barcelona) Spain
Phone: +34-93-470-55-00
Fax: +34-93-371-78-49



Join
Us



Follow
Us



Watch
Us



Download
It

3i T3, ACT, BellaTek design, Certain, Encode, EP, OSSEOTITE and QuickSeat are registered trademarks of BIOMET 3i. NanoTite, No-Touch and Providing Solutions – One Patient At A Time are trademarks of BIOMET 3i LLC. ©2014 BIOMET 3i LLC.

All trademarks herein are the property of BIOMET 3i LLC unless otherwise indicated. This material is intended for clinicians only and is not intended for patient distribution. This material is not to be redistributed, duplicated, or disclosed without the express written consent of BIOMET 3i. For additional product information, including indications, contraindications, warnings, precautions, and potential adverse effects, see the product package insert and the BIOMET 3i Website: www.ifu.biomet3i.com.



CAISM
REV K 03/14