

Product Catalog

For Site Preparation & Surgical Technologies



Table Of Contents

Introduction

Company Overview	i
Implant & Abutment System Connections	ii
Implant Body & Connection Types	iv
Certain® Platform Switching Implants	v
Surface Technologies	
The 3i T3® Implant Family	vi
The NanoTite™ Implant Family	vii
The OSSEOTITE® Implant Family	vii
Top-Down Treatment Planning	viii

Certain Internal Connection Implants

Tapered

3i T3 With DCD® Platform Switched	1
3i T3 With DCD Non-Platform Switched	1
3i T3 Platform Switched	1
3i T3 Non-Platform Switched	1
NanoTite Tapered Certain PREVAIL®	3
NanoTite Tapered Certain	3
OSSEOTITE Tapered Certain PREVAIL	4
Full OSSEOTITE Tapered Certain	4

Parallel Walled

3i T3 With DCD Platform Switched	2
3i T3 With DCD Non-Platform Switched	2
3i T3 Platform Switched	2
3i T3 Non-Platform Switched	2
NanoTite Certain PREVAIL	5
OSSEOTITE 2 Certain PREVAIL	5
NanoTite Parallel Walled Certain	6
OSSEOTITE 2 Parallel Walled Certain	6

External Hex Connection Implants

Tapered Implants

3i T3 Tapered With DCD	7
3i T3 Tapered	7
NanoTite Tapered	7
Full OSSEOTITE Tapered	8
OSSEOTITE Tapered	8

Parallel Walled

3i T3 Parallel Walled With DCD	7
3i T3 Parallel Walled	7
NanoTite Parallel Walled	9
OSSEOTITE 2 Parallel Walled	9
Full OSSEOTITE Parallel Walled	10
OSSEOTITE Parallel Walled	10

Healing Abutments

Certain Internal Connection

<i>BellaTek</i> Encode® Two-Piece	12
EP® One-Piece	13

External Hex Connection

BellaTek® Encode Two-Piece	15
EP One-Piece	16

Site Preparation Technologies

Product Overview	17
DUI000 Surgical Drilling Unit	19
OSSEOCISION® Surgical Drilling Unit	20
Tapered Navigator® System For Guided Surgery	21
Parallel Walled Navigator System For Guided Surgery	25
Tapered Implant Surgical Kits	28
Parallel Walled Surgical Kits	31
ACT® Non-Irrigated Reusable Twist Drills	35
Surgical Drills	
Drills, Quad Shaping Drills For Tapered Implants	35
Surgical Components	
Handpiece Bone Profilers	36
Low Profile Abutment Bone Profilers	36
Certain Manual Bone Profilers	36
Bone Profiler Guide Pins	36
Bone Profiler Organizers & Kits	36
Bone Taps, Dense Bone Taps For Tapered Implants	37
Depth/Direction Indicators For Tapered Implants,	
Direction Indicators, Mounts	38
Miscellaneous Instrumentation	39
Site Preparation Components	
Straight And Angled Osteotomes,	
Summer Osteotomes	41
Sinus Elevation, Trephine Burs	42

Regenerative Technologies

Product Overview	43
Allografts	
RegenerOss® Allograft	45
RegenerOss Allograft Putty	46
RegenerOss Allograft Putty Plus	46
Xenografts	
Endobon® Xenograft Granules	47
GBR Barriers	
OsseoGuard® & OsseoGuard Flex® Membranes	47
Alloplasts	
Biogran®	47
Autogenous	
Safescraper® TWIST, R. Quétin Bone-Mill	47

Patient Education Products

Additional Information

Important Product Information For Dental Implants	49
Important Product Information For Restorative Products	50
Index	51
Ordering Form	64
Ordering Information	66

Introduction

Company Overview



Providing Solutions – One Patient At A Time™

Mission Statement:

BIOMET 3i will be recognized as a global leader in the oral reconstruction marketplace. We will achieve this through superior customer support and continuous product innovation.

Headquartered in Palm Beach Gardens, Florida, with operations throughout the world, BIOMET **3i** is one of the leading companies in the oral reconstruction market. Of equal importance, BIOMET **3i** brings the same innovation, high standards and comprehensive approach to customer service, dental practice and laboratory support and education.

BIOMET **3i** offers one of implant dentistry's most comprehensive lines of implants and abutments, augmented by a growing line of site preparation, digital, restorative and regenerative products.

BIOMET **3i** pioneered the development of biologically driven implants, winning worldwide acclaim for the micro-textured OSSEOTITE® surface and then the nano-scaled, Bone Bonding® NanoTite™ Surface Implants. The tradition of implant innovation continues with the introduction of the **3i** T3® Implant, a contemporary hybrid that is designed for sustainable aesthetics.

This spirit of innovation continues with the introduction of DIEM®2, a protocol to enable clinicians to pursue immediate provisionalization options for full arch patient cases.



Introduction

Implant & Abutment System Connections

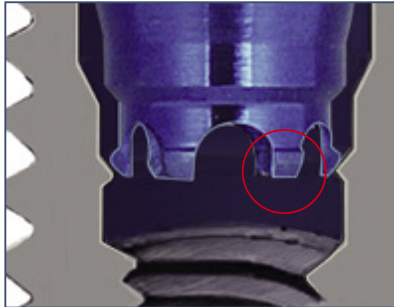

Certain® Internal Connection

The internal connection aspect of the implant and abutment are designed for ease of use and simplicity.

- QuickSeat® Connection: It Clicks! The Certain Implant and Abutment Systems feature the QuickSeat Connection. This unique connection produces an audible and tactile “click” that confirms placement of Impression Copings and Abutments.

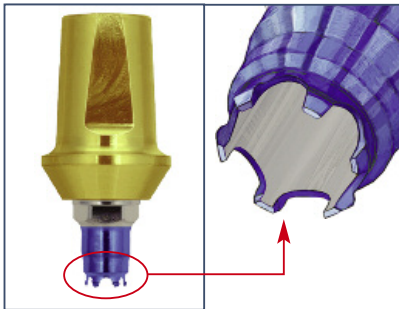



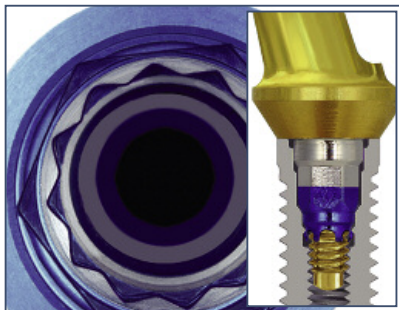

- Abutment fingers cause the “click” and also provide retention for the prosthetic components in the implant before the screw is placed. A screw is needed to fully seat the components when the restoration is being tried in or definitively placed.



- The 6/12 hex inside the internal connection incorporates both a 6-point single and a 12-point double hex. The 6-point single hex has two functions: engaging the driver tip for mountless delivery during implant placement and providing anti-rotation for all straight abutments. The 12-point double hex provides 30° rotational positioning for pre-angled abutments.



- Impression Copings: Pick-Up and Twist Lock™ Transfer Copings are available in the Certain Internal Connection design, in three EP® (Emergence Profile) diameters and a straight diameter to match the corresponding Healing Abutment. The Impression Copings also “click” when properly seated. These copings have a different finger design that engages 2mm internally into the implant, as compared to the abutment’s design that engages 4mm deep into the implant. This shorter engagement into the implant is important because it allows off-axis draw for implant impressions that are divergent.

(purple)	(blue)	(yellow)	(green)
			
3.4mm	4.1mm	5mm	6mm

- Color-Coding: Certain Implants and all interfacing components are color-coded by restorative platform diameter for easy identification and selection.

Introduction

Implant & Abutment System Connections

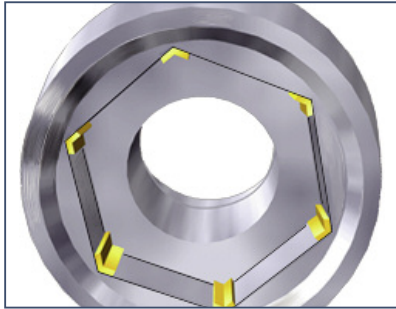

External Hex Connection

The external hex connection implant and abutment designs have been widely used in implant dentistry.

- Gold Standard ZR (Zero Rotation) is a patented design incorporating machined microstops within the corners of the hex in the abutment. The design reduces horizontal rotation between the implant and abutment. Gold Standard ZR is available on UCLA, GingiHue® and Conical Abutments.

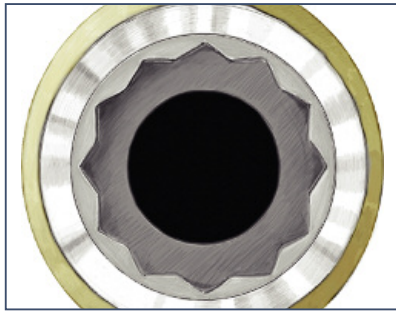

- The 12-point double hex, which is machined in the 15° Pre-Angled GingiHue Abutment, provides rotational positioning in 30° increments on the implant hex.

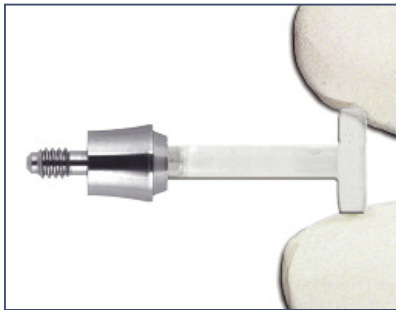

- Precise Abutment Placement: The ASYST Abutment Placement Tool provides fingertip control for fast and easy abutment delivery. The patented packaging design makes abutment placement easier because the abutment is delivered sterile from the package directly to the implant site. The abutment and abutment screw are packaged inside the plastic ASYST seating device. The plastic seating device facilitates precise placement of the abutment on the implant, thus reducing chair time. The ASYST Tool is packaged with Low Profile, Standard and Conical Abutments.



- Impression Copings: Pick-Up and Twist Lock™ Transfer Copings are both available in the external connection design in three EP® (Emergence Profile) diameters and a straight diameter to match the corresponding healing abutment. The patented Twist Lock design provides a more accurate transfer of the implant connection as compared to other transfer (closed tray) techniques. This unique Twist Lock feature provides a series of undercuts to guide the coping into the impression, giving stability to the impression coping/analog prior to pouring the impression. As a result, the copings lock into orientation grooves upon clockwise rotation, thereby allowing for a tactile sensation of resistance that ensures an accurate hex transfer.

Introduction

Implant Body & Connection Types

Icon Descriptions:

The following icons are used to represent the connection type of the implant system:

 **Internal**  **External**

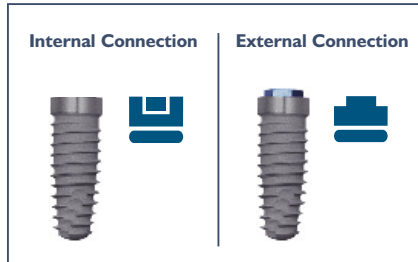

Certain[®] Internal Connection Tapered Implants & External Hex Connection Tapered Implants

Tapered Implants closely approximate the shape of a natural tooth root with a thread design that produces an anchoring “bite in bone” response. These implants are available in the **3i** T3[®] Contemporary Hybrid, NanoTite™ and OSSEOTITE[®] Surface configurations.

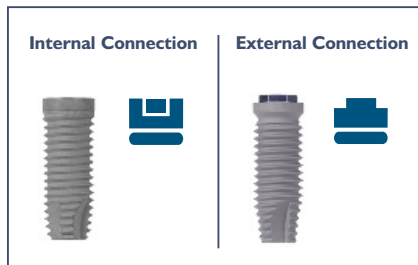

Certain Internal Connection Implants & External Hex Connection Parallel Walled Implants

Parallel Walled Implants feature a unique ICE™ Self-Tapping Design. These implants are available in the **3i** T3 Contemporary Hybrid, NanoTite and OSSEOTITE Surface configurations.

Introduction

Certain® Platform Switching Implant

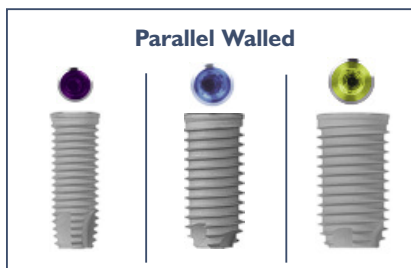
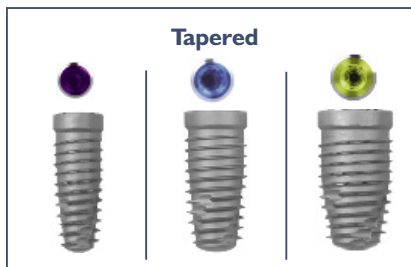
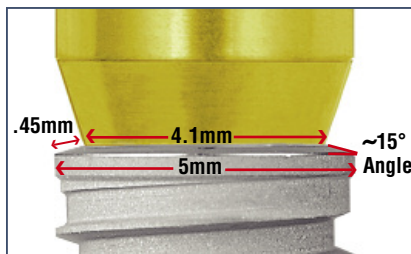

Overview

BIOMET 3i created an implant system that is designed to help clinicians in the pursuit of crestal bone preservation. The Certain Platform Switching Implant features integrated platform switching, which incorporates a coronal bevel design that medializes the Implant Abutment Junction (IAJ). This feature is available on 3i T3®, OSSEOTITE® and NanoTite™ Implants unless otherwise noted. The surface extends to the top of the collar where the medialization of the implant begins, creating a continuous bone loading surface.

The Certain Platform Switching Implant offers the Certain QuickSeat® Connection. This provides the clinician with an audible and tactile click that confirms the abutment is properly seated. The double hex allows for as many as 12 rotational positions, which is ideal for angled abutments.

The Certain Platform Switching Implant's prosthetic table is appropriately color-coded to ensure proper matching of the corresponding BIOMET 3i Abutments.

The Certain Platform Switching Implant is offered in two different implant configurations:

Tapered Certain Platform Switching Implant

Incorporates all of the design features of a platform switching implant with a tapered design, which approximates the shape of a natural tooth root. The innovative thread angle, depth and pitch produce an anchoring "bite in bone" response for establishing primary stability.

Parallel Walled Certain Platform Switching Implant

The straight collar design incorporates platform switching using a parallel walled implant.

Introduction

Surface Technologies

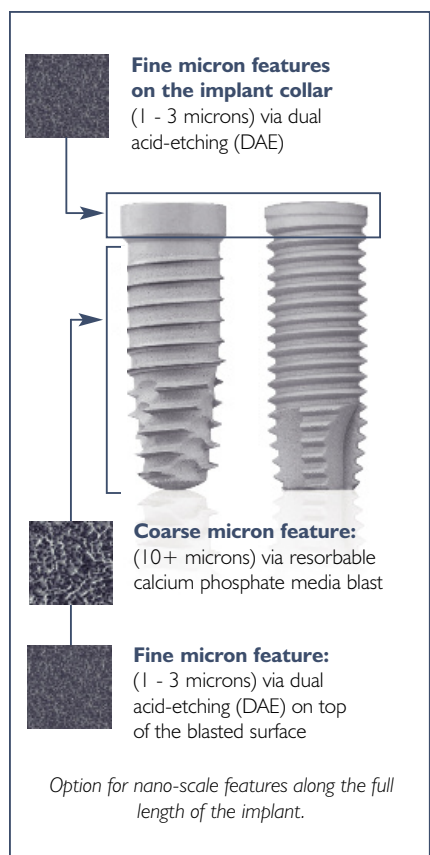

The **3i** T3® Implant Family

The **3i** T3 Implant represents the most recent advanced dental implant surface technology since the introduction of the NanoTite™ Implant in 2007. This latest surface technology is designed to deliver aesthetic results through tissue preservation.

A contemporary hybrid surface is provided by complex multi-surface topography. In preclinical studies*, the **3i** T3 with DCD® Surface demonstrated increased integration strength throughout the healing phase as compared to less complex surface topographies.¹

Osseointegration is achieved with initial bone-to-implant contact, a major contributor to the implant's stability.² The specifications of the **3i** T3 Implant and surgical instrumentation are held to rigorous tolerances to provide a closely integrated implant-to-osteotomy fit, creating a dental implant system designed for primary stability.

The seal integrity is provided by a stable, tight implant/abutment interface that can minimize abutment micromotion and reduce the potential for microleakage.³ The seal strength is designed to reduce microleakage through exacting interface tolerances and maximized clamping forces.

The **BIOMET 3i**® Gold-Tite® Screw increases implant/abutment clamping force by 113% as compared to a non-coated screw with the Certain® Implant.⁴ The patented Gold-Tite Surface lubrication allows the screw to rotate further, increasing clamping force and maximizing abutment stability.⁵ Implants with integrated platform switching medialize the implant/abutment junction (IAJ) inward, creating a biologic width between connective tissue and the IAJ, helping to maintain bone levels.⁶

1. Davies JE†, Ajami E, Moinuddin R, et al. The role of different scale ranges of surface implant topography on the stability of the bone/implant interface. *Biomaterials* 2013;34(14):3535-3546. Epub 2013 Feb 14.
2. Meredith N. Assessment of implant stability as a prognostic determinant. *Int J Prosthodont*. 1998 Sep-Oct;11(5):491-501.
3. Gubbi P†, Suttin Z†, Towse R†. Microgap analysis at the implant-abutment interface of various dental implant systems. Poster Presentation (P-98): Academy of Osseointegration 28th Annual Meeting, March 2013, Tampa, Florida, USA.
4. Suttin Z††, Towse R††. Effect of abutment screw design on implant system seal performance. Presented at the European Association for Osseointegration, 20th Annual Scientific Meeting; October 2012; Copenhagen, Denmark. http://biomet3i.com/Pdf/Posters/P-450_Effect_of_Screw_Design_on_Implant_Seal.pdf
5. Byrne D, Jacobs S, O'Connell B, Houston F, Claffey N. Preloads generated with repeated tightening in three types of screws used in dental implant assemblies. *J. Prosthodont*. 2006 May-Jun;15(3):164-171.
6. Lazzara R†, Porter SS. Platform switching: A new concept in implant dentistry for controlling post-restorative crestal bone levels. *Int J Perio Rest Dent*. 2006;26:9-17.

† JE Davies and R. Lazzara have financial relationships with BIOMET **3i** LLC resulting from speaking engagements, consulting engagements and other retained services.

†† Mr. Gubbi, Mr. Suttin and Mr. Towse contributed to the above research while employed by BIOMET **3i**.

*Pre-clinical studies are not necessarily indicative of clinical results.

Introduction

Surface Technologies

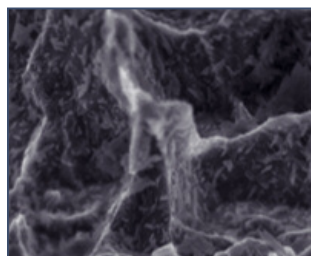

NanoTite Surface at 20,000x magnification

The NanoTite™ Implant Family

The NanoTite Implant is the patented OSSEOTITE® dual-acid-etched surface, which is then further treated with a deposition of nanometer scale crystals of calcium phosphate. This is known as the Discrete Crystalline Deposition or DCD® Process. The surface treatment is a discrete crystalline deposition on the OSSEOTITE Surface, not a plasma sprayed coating.

The synergistic effect of these two technologies, the OSSEOTITE Surface and the DCD Process has demonstrated promising results in animal studies.* Because of this synergistic effect, a more complex micro-surface is created. Preclinical studies* demonstrated that the NanoTite Surface treatment, when compared to OSSEOTITE Control Implants, significantly improved the rate and extent of bone-to-implant contact, resulting in statistically significant enhanced integration.^{1,2}

For all NanoTite Configurations, wherever there is the dual-acid-etched OSSEOTITE Surface, the DCD nano-scale calcium phosphate has been applied.

1. Mendes VC, Davies JE[†]. Discrete calcium phosphate nanocrystals enhance osteoconduction on titanium-based implant surfaces. *Canadian Biomaterials Society, 25th Annual Meeting, May 26-28, 2006, Calgary, Alberta, Canada.*

2. Mendes VC, Davies JE[†]. Discrete calcium phosphate nanocrystals render titanium surfaces bone-bonding. *Int J Oral Maxillofac Implant.* 2007;22:484.

*Pre-clinical studies are not necessarily indicative of clinical results.

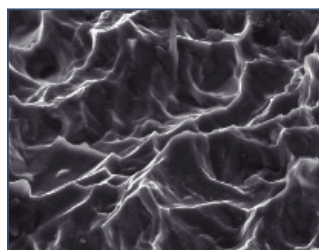

OSSEOTITE Surface at 20,000x magnification

The OSSEOTITE® Implant Family

The OSSEOTITE Implant features the **BIOMET 3i**™ patented dual-acid-etched surface that is optimal for improving the clot/implant attachment, which may increase platelet activation and red blood cell (rbc) agglomeration.¹

For more than 15 years, with documentation from numerous global multicenter clinical evaluations,²⁻⁹ the OSSEOTITE Surface has proven to be one of the most predictable and well-researched surfaces ever. Clinical studies on the OSSEOTITE Surface document the benefits of increased contact osteogenesis, especially in poor quality bone.¹⁰

1. Park JY, Davies JE[†]. Red Blood Cell and Platelet Interactions with Titanium Implant Surfaces. *Clinical Oral Implants Research.* 2000;11:530-539.
2. Sullivan DY, Sherwood RL, Porter SS. Long-Term Performance of OSSEOTITE Implants: A 6-Year Clinical Follow-up. *Compendium.* April 2001; Vol. 22, No. 4.
3. Davarpanah M, Martinez H, Etienne D, Zabalegui I, Mattout P, Chiche F[†], Michel J. A Prospective Multicenter Evaluation of 1,538 **3i** Implants: 1 to 5-year Data. *The International Journal of Oral & Maxillofacial Implants.* 2002; Vol. 17, No. 6.
4. Feldman S, Boitel N, Weng D, Kohles SS, Stach RM^{††}. Five-Year Survival Distributions of Short-Length (10mm or less) Machined-Surfaced and OSSEOTITE Implants. *Clinical Implant Dentistry and Related Research.* 2004; Vol. 6, No. 1.
5. Sullivan D, Vincenzi G, Feldman S. Early Loading of OSSEOTITE Implants 2 Months After Placement in the Maxilla and Mandible: A 5-year Report. *The International Journal of Oral & Maxillofacial Implants.* 2006; Vol. 20, No. 6.
6. Stach RM^{††}, Kohles SS. A Meta-Analysis Examining the Clinical Survivability of Machined-Surfaced and OSSEOTITE Implants in Poor-Quality Bone. *Implant Dentistry.* 2003; Vol. 12, No. 1.
7. Testori T[†], Wiseman L, Woolfe S, Porter SS. A Prospective Multicenter Clinical Study of the OSSEOTITE Implant: Four-Year Interim Report. *The International Journal of Oral & Maxillofacial Implants.* 2001;16:193-200.
8. Gaucher H, Bentley K, Roy S, Head T, Blomfield J, Blondeau F, Nicholson L, Chehade A, Tardif N, Emery R[†]. A Multi-Centre Study of OSSEOTITE Implants Supporting Mandibular Restorations: A 3-Year Report. *Journal of the Canadian Dental Association.* October 2001; Vol. 67, No. 9.
9. Testori T[†], Fabbro MD, Feldman S, Vincenzi G, Sullivan D, Rossi R, Anitua E, Bianchi F, Francetti L, Weinstein RL. A Multicenter Prospective Evaluation of 2-months Loaded OSSEOTITE Implants Placed in the Posterior Jaws: 3-year Follow-up Results. *Clinical Oral Implants Research.* 2002;13:154-161.
10. Stach RM^{††}, Kohles SS. A Meta-Analysis Examining the Clinical Survivability of Machined-Surfaced and OSSEOTITE Implants In Poor Quality Bone. *Implant Dent* 2003;12:87-96.

† F Chiche, JE Davies, R Emory and T Testori have financial relationships with BIOMET **3i** LLC resulting from speaking engagements, consulting engagements and other retained services.

†† RM Stach contributed to the above research while employed by BIOMET **3i**.

Top-Down Treatment Planning

In its simplest form, top-down treatment planning refers to a guideline whereby the desired restorative result is considered first, leading to consideration of the appropriate prosthetic platform and subsequent implant selection based on bony anatomy and the size of the missing tooth.

A top-down treatment planning methodology will provide maximum biomechanical stability and allow for soft-tissue flaring by utilizing an implant with a prosthetic platform slightly smaller in diameter than the emergence diameter of the tooth being replaced. The wide selection of **COMET 3i** Implants allows clinicians to match the size of the prosthetic platform to the restoration it will eventually support, while allowing for different bone volumes and anatomical features at the implant site.

Implant and healing abutment selections are based upon the relationship of several key measurements:

- The emerging dimension of the crown in relation to the diameter of the prosthetic platform of the implant
- The height and diameter of the intended restoration at the tissue exit point
- The bone volume at the implant site in relation to the diameter of the implant body

The Emergence Profile (EP®) Healing Abutment System consists of healing abutments of various diameters and heights for shaping the soft tissue to replicate the geometry and gingival contours of natural dentition.

Implant Indications: Include both straight and pre-angled restorative components.

	3.25mm(D)	3.75mm(D)	4mm(D)	5mm(D)	6mm(D)	4mm(D) X 3.4mm(P)	5mm(D) X 4.1mm(P)	6mm(D) X 5mm(P)
Anterior	✓	✓	✓	✓	✓	✓	✓	✓
Posterior			✓	✓	✓	✓	✓	✓

NOTE: It is recommended that implants less than 4mm diameter not be placed in the posterior regions.

Top-Down Treatment Planning

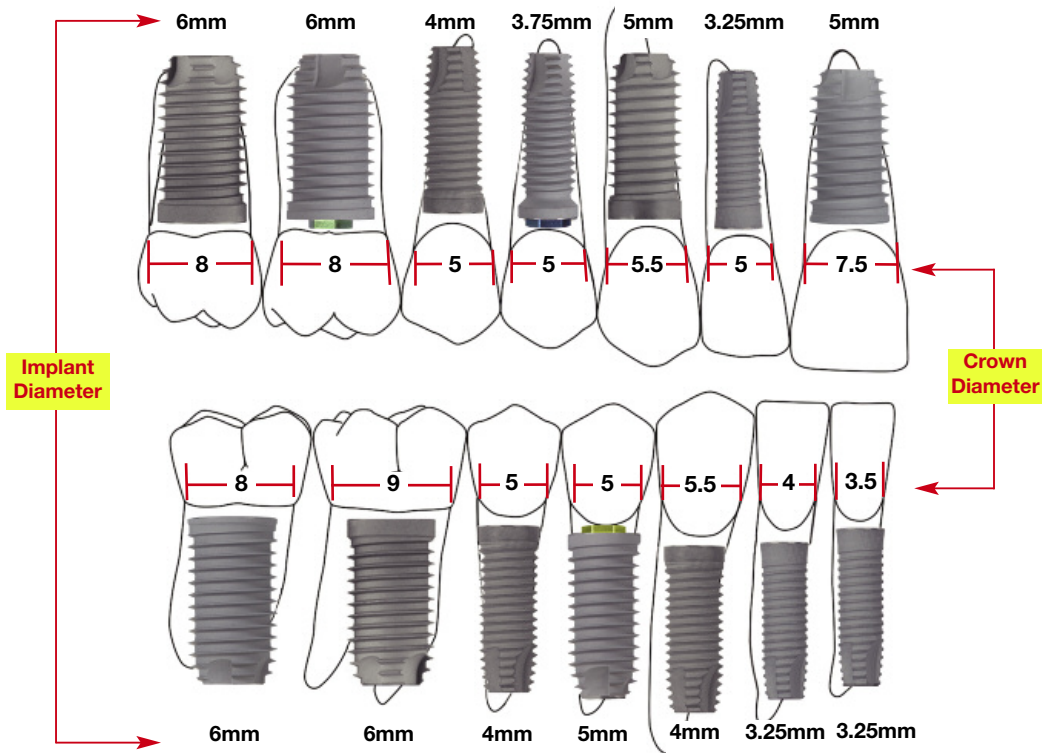
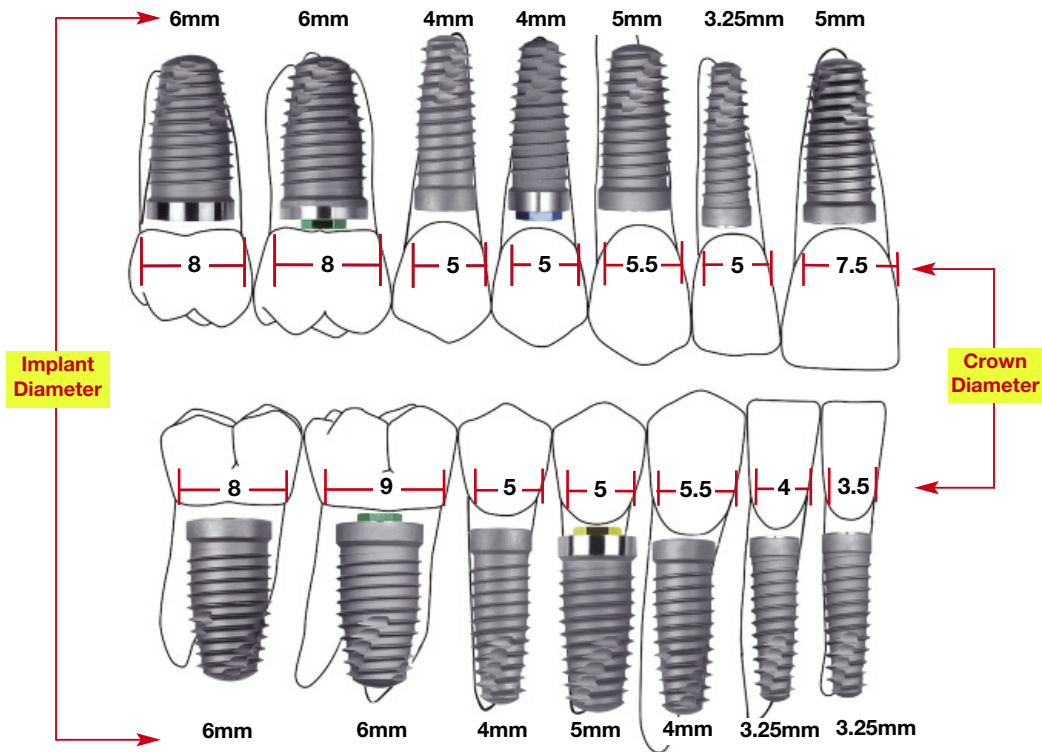



Certain® Internal Connection Implants

Tapered

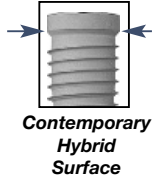

3i T3® With DCD® Platform Switched

Commercially Pure Titanium

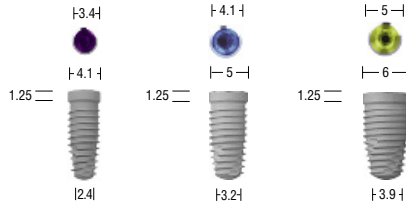

3i T3 With DCD Non-Platform Switched

Commercially Pure Titanium

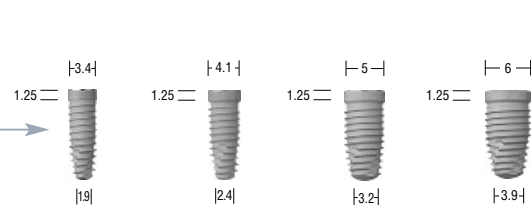

Length	4mm(D) X 3.4mm(P)	5mm(D) X 4mm(P)	6mm(D) X 5mm(P)	3.25mm(D)	4mm(D)	5mm(D)	6mm(D)
8.5mm	BNPT4385	BNPT5485	BNPT6585	BNST3285	BNST485	BNST585	BNST685
10mm	BNPT4310	BNPT5410	BNPT6510	BNST3210	BNST410	BNST510	BNST610
11.5mm	BNPT4311	BNPT5411	BNPT6511	BNST3211	BNST411	BNST511	BNST611
13mm	BNPT4313	BNPT5413	BNPT6513	BNST3213	BNST413	BNST513	BNST613
15mm	BNPT4315	BNPT5415	BNPT6515	BNST3215	BNST415	BNST515	BNST615

3i T3 Platform Switched

Commercially Pure Titanium

8.5mm	BOPT4385	BOPT5485	BOPT6585
10mm	BOPT4310	BOPT5410	BOPT6510
11.5mm	BOPT4311	BOPT5411	BOPT6511
13mm	BOPT4313	BOPT5413	BOPT6513
15mm	BOPT4315	BOPT5415	BOPT6515

3i T3 Non-Platform Switched

Commercially Pure Titanium

8.5mm	BOST3285	BOST485	BOST585	BOST685
10mm	BOST3210	BOST410	BOST510	BOST610
11.5mm	BOST3211	BOST411	BOST511	BOST611
13mm	BOST3213	BOST413	BOST513	BOST613
15mm	BOST3215	BOST415	BOST515	BOST615

Cover Screw Flat (included)							
Cover Screw 1mm(H)	IMMCS1	ICS375*	ICS500	IMMCS1	ICS375*	ICS500	ICS600

*Non-Flared 4.1mm(P) Cover Screw ICS400 is also available.

All indicated measurements are in millimeters.

Some products may not be available outside of the United States.
 Algunos productos no se comercializan fuera de EE.UU.
 Certains produits ne sont pas disponibles en dehors des États-Unis.
 Einige Produkte sind außerhalb der USA nicht erhältlich.

Certain® Internal Connection Implants

Parallel Walled

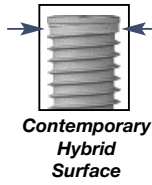

3i T3® With DCD® Platform Switched

Commercially Pure Titanium

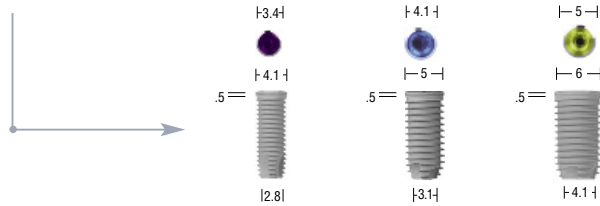

3i T3 With DCD Non-Platform Switched

Commercially Pure Titanium

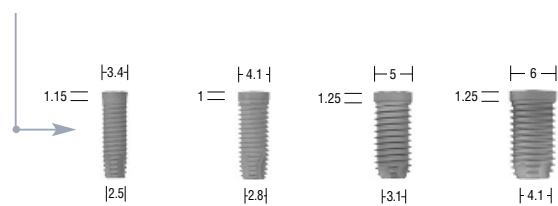

Length	4mm(D) X 3.4mm(P)	5mm(D) X 4mm(P)	6mm(D) X 5mm(P)	3.25mm(D)	4mm(D)	5mm(D)	6mm(D)
8.5mm	BNPS4385	BNPS5485	BNPS6585	BNSS385	BNSS485	BNSS585	BNSS685
10mm	BNPS4310	BNPS5410	BNPS6510	BNSS310	BNSS410	BNSS510	BNSS610
11.5mm	BNPS4311	BNPS5411	BNPS6511	BNSS311	BNSS411	BNSS511	BNSS611
13mm	BNPS4313	BNPS5413	BNPS6513	BNSS313	BNSS413	BNSS513	BNSS613
15mm	BNPS4315	BNPS5415	BNPS6515	BNSS315	BNSS415	BNSS515	BNSS615
18mm	—	—	—	BNSS318	BNSS418	—	—

3i T3 Platform Switched

Commercially Pure Titanium

8.5mm	BOPS4385	BOPS5485	BOPS6585
10mm	BOPS4310	BOPS5410	BOPS6510
11.5mm	BOPS4311	BOPS5411	BOPS6511
13mm	BOPS4313	BOPS5413	BOPS6513
15mm	BOPS4315	BOPS5415	BOPS6515
18mm	—	—	—

3i T3 Non-Platform Switched

Commercially Pure Titanium

8.5mm	BOSS385	BOSS485	BOSS585	BOSS685
10mm	BOSS310	BOSS410	BOSS510	BOSS610
11.5mm	BOSS311	BOSS411	BOSS511	BOSS611
13mm	BOSS313	BOSS413	BOSS513	BOSS613
15mm	BOSS315	BOSS415	BOSS515	BOSS615
18mm	BOSS318	BOSS418	—	—

Cover Screw Flat (included)							
	IMCSF34	ICSF41	ICSF50	IMCSF34	ICSF41	ICSF50	ICSF60
Cover Screw 1mm(H)	IMMCS1	ICS375*	ICS500	IMMCS1	ICS375*	ICS500	ICS600

*Non-Flared 4.1mm(P) Cover Screw ICS400 is also available.

All indicated measurements are in millimeters.

Some products may not be available outside of the United States.
 Algunos productos no se comercializan fuera de EE.UU.
 Certains produits ne sont pas disponibles en dehors des États-Unis.
 Einige Produkte sind außerhalb der USA nicht erhältlich.



Certain® Internal Connection Implants

Tapered

NanoTite™ Tapered Certain PREVAIL®

Titanium Alloy

Full NanoTite Surface





Length	4/3mm(P)	5/4mm(P)	6/5mm(P)
8.5mm	NIITP4385	NIITP5485	NIITP6585
10mm	NIITP4310	NIITP5410	NIITP6510
11.5mm	NIITP4311	NIITP5411	NIITP6511
13mm	NIITP4313	NIITP5413	NIITP6513
15mm	NIITP4315	NIITP5415	NIITP6515
Cover Screw Flat (included)	 IMCSF34	 ICSF41	 ICSF50
Cover Screw 1mm(H)	IMMCS1	ICS375*	ICS500

*Non-Flared 4.1mm(P) Cover Screw ICS400 is also available.

NanoTite Tapered Certain

Titanium Alloy

Modified Hybrid NanoTite Surface

Length	3.25mm(D)	4mm(D)	5mm(D)	6mm(D)
8.5mm	NINT3285	NINT485	NINT585	NINT685
10mm	NINT3210	NINT410	NINT510	NINT610
11.5mm	NINT3211	NINT411	NINT511	NINT611
13mm	NINT3213	NINT413	NINT513	NINT613
15mm	NINT3215	NINT415	NINT515	NINT615
Cover Screw Flat (included)	 IMCSF34	 ICSF41	 ICSF50	 ICSF60
Cover Screw 1mm(H)	IMMCS1	ICS375*	ICS500	ICS600

*Non-Flared 4.1mm(P) Cover Screw ICS400 is also available.



All indicated measurements are in millimeters.

Some products may not be available outside of the United States.
 Algunos productos no se comercializan fuera de EE.UU.
 Certains produits ne sont pas disponibles en dehors des États-Unis.
 Einige Produkte sind außerhalb der USA nicht erhältlich.

Certain® Internal Connection Implants





Tapered

OSSEOTITE® Tapered Certain PREVAIL®
Commercially Pure Titanium

Length	4/3mm(P)	5/4mm(P)	6/5mm(P)
8.5mm	XIITP4385	XIITP5485	XIITP6585
10mm	XIITP4310	XIITP5410	XIITP6510
11.5mm	XIITP4311	XIITP5411	XIITP6511
13mm	XIITP4313	XIITP5413	XIITP6513
15mm	XIITP4315	XIITP5415	XIITP6515
Cover Screw Flat (included)	 IMCSF34	 ICSF41	 ICSF50
Cover Screw 1mm(H)	IMMCS1	ICS375*	ICS500

*Non-Flared 4.1mm(P) Cover Screw ICS400 is also available.

Full OSSEOTITE Tapered Certain
Commercially Pure Titanium

Length	3.25mm(D)	4mm(D)	5mm(D)	6mm(D)
8.5mm	XIFNT3285	XIFNT485	XIFNT585	XIFNT685
10mm	XIFNT3210	XIFNT410	XIFNT510	XIFNT610
11.5mm	XIFNT3211	XIFNT411	XIFNT511	XIFNT611
13mm	XIFNT3213	XIFNT413	XIFNT513	XIFNT613
15mm	XIFNT3215	XIFNT415	XIFNT515	XIFNT615
Cover Screw Flat (included)	 IMCSF34	 ICSF41	 ICSF50	 ICSF60
Cover Screw 1mm(H)	IMMCS1	ICS375*	ICS500	ICS600

*Non-Flared 4.1mm(P) Cover Screw ICS400 is also available.



All indicated measurements are in millimeters.

Some products may not be available outside of the United States.
Algunos productos no se comercializan fuera de EE.UU.
Certains produits ne sont pas disponibles en dehors des États-Unis.
Einige Produkte sind außerhalb der USA nicht erhältlich.

Certain® Internal Connection Implants



Parallel Walled

NanoTite™ Certain PREVAIL®
Titanium Alloy

Length	4/3mm(P)	5/4mm(P)
8.5mm	NIIOS4385	NIIOS5485
10mm	NIIOS4310	NIIOS5410
11.5mm	NIIOS4311	NIIOS5411
13mm	NIIOS4313	NIIOS5413
15mm	NIIOS4315	NIIOS5415
Cover Screw Flat (included)	 IMCSF34	 ICSF41
Cover Screw 1mm(H)	IMMCS1	ICS375*

*Non-Flared 4.1mm(P) Cover Screw ICS400 is also available.

OSSEOTITE®2 Certain PREVAIL
Commercially Pure Titanium

Length	4/3mm(P)	5/4mm(P)	6/5mm(P)
8.5mm	XIIOS4385	XIIOS5485	XIIOS6585
10mm	XIIOS4310	XIIOS5410	XIIOS6510
11.5mm	XIIOS4311	XIIOS5411	XIIOS6511
13mm	XIIOS4313	XIIOS5413	XIIOS6513
15mm	XIIOS4315	XIIOS5415	XIIOS6515
Cover Screw Flat (included)	 IMCSF34	 ICSF41	 ICSF50
Cover Screw 1mm(H)	IMMCS1	ICS375*	ICS500

*Non-Flared 4.1mm(P) Cover Screw ICS400 is also available.

All indicated measurements are in millimeters.

Some products may not be available outside of the United States.
Algunos productos no se comercializan fuera de EE.UU.
Certains produits ne sont pas disponibles en dehors des États-Unis.
Einige Produkte sind außerhalb der USA nicht erhältlich.



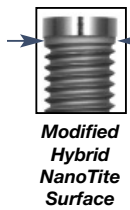

Certain® Internal Connection Implants

Parallel Walled



NanoTite™ Parallel Walled Certain

Titanium Alloy





Length	3.25mm(D)	4mm(D)	5mm(D)	6mm(D)
8.5mm	NIOSM385	NIOSS485	NIOSS585	NIOSS685
10mm	NIOSM310	NIOSS410	NIOSS510	NIOSS610
11.5mm	NIOSM311	NIOSS411	NIOSS511	NIOSS611
13mm	NIOSM313	NIOSS413	NIOSS513	NIOSS613
15mm	NIOSM315	NIOSS415	NIOSS515	NIOSS615
18mm	NIOSM318	NIOSS418	N/A	N/A
Cover Screw Flat (included)	 IMCSF34	 ICSF41	 ICSF50	 ICSF60
Cover Screw 1mm(H)	IMMCS1	ICS375*	ICS500	ICS600

*Non-Flared 4.1mm(P) Cover Screw ICS400 is also available.



OSSEOTITE® Parallel Walled Certain

Commercially Pure Titanium

Length	3.25mm(D)	4mm(D)	5mm(D)	6mm(D)
8.5mm	XIFOSM385	XIFOSS485	XIFOSS585	XIFOSS685
10mm	XIFOSM310	XIFOSS410	XIFOSS510	XIFOSS610
11.5mm	XIFOSM311	XIFOSS411	XIFOSS511	XIFOSS611
13mm	XIFOSM313	XIFOSS413	XIFOSS513	XIFOSS613
15mm	XIFOSM315	XIFOSS415	XIFOSS515	XIFOSS615
Cover Screw Flat (included)	 IMCSF34	 ICSF41	 ICSF50	 ICSF60
Cover Screw 1mm(H)	IMMCS1	ICS375*	ICS500	ICS600

*Non-Flared 4.1mm(P) Cover Screw ICS400 is also available.

All indicated measurements are in millimeters.

Some products may not be available outside of the United States.
 Algunos productos no se comercializan fuera de EE.UU.
 Certains produits ne sont pas disponibles en dehors des États-Unis.
 Einige Produkte sind außerhalb der USA nicht erhältlich.



External Hex Connection Implants

Tapered & Parallel Walled



3i T3® Tapered With DCD®

Commercially Pure Titanium

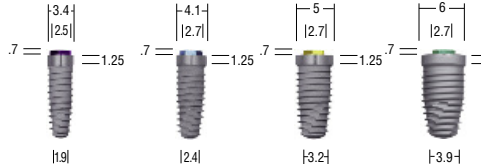

3i T3 Parallel Walled With DCD

Commercially Pure Titanium

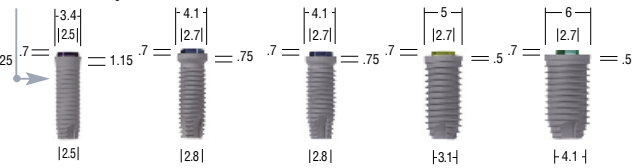

Length	3.25mm(D)	4mm(D)	5mm(D)	6mm(D)	3.25mm(D)	3.75mm(D)	4mm(D)	5mm(D)	6mm(D)
6.5mm	—	—	—	—	BNES365	BNES3765	BNES465	BNES565	BNES665
8.5mm	BNET3285	BNET485	BNET585	BNET685	BNES385	BNES3785	BNES485	BNES585	BNES685
10mm	BNET3210	BNET410	BNET510	BNET610	BNES310	BNES3710	BNES410	BNES510	BNES610
11.5mm	BNET3211	BNET411	BNET511	BNET611	BNES311	BNES3711	BNES411	BNES511	BNES611
13mm	BNET3213	BNET413	BNET513	BNET613	BNES313	BNES3713	BNES413	BNES513	BNES613
15mm	BNET3215	BNET415	BNET515	BNET615	BNES315	BNES3715	BNES415	BNES515	BNES615
18mm	—	—	—	—	BNES318	BNES3718	BNES418	BNES518	BNES618

3i T3 Tapered

Commercially Pure Titanium

6.5mm	—	—	—	—
8.5mm	BOET3285	BOET485	BOET585	BOET685
10mm	BOET3210	BOET410	BOET510	BOET610
11.5mm	BOET3211	BOET411	BOET511	BOET611
13mm	BOET3213	BOET413	BOET513	BOET613
15mm	BOET3215	BOET415	BOET515	BOET615
18mm	—	—	—	—

3i T3 Parallel Walled

Commercially Pure Titanium

6.5mm	BOES365	BOES3765	BOES465	BOES565	BOES665
8.5mm	BOES385	BOES3785	BOES485	BOES585	BOES685
10mm	BOES310	BOES3710	BOES410	BOES510	BOES610
11.5mm	BOES311	BOES3711	BOES411	BOES511	BOES611
13mm	BOES313	BOES3713	BOES413	BOES513	BOES613
15mm	BOES315	BOES3715	BOES415	BOES515	BOES615
18mm	BOES318	BOES3718	BOES418	BOES518	BOES618

Cover Screw 1mm(H) (included)	MMCS1	CS375	CS500	CS600	MMCS1	CS375	CS375	CS500	CS600
Cover Screw Headless	CS275	CS275	CS275	CS275	CS275	CS275	CS275	CS275	CS275

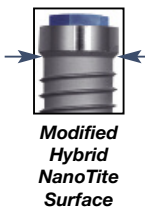

NanoTite™ Tapered

Titanium Alloy

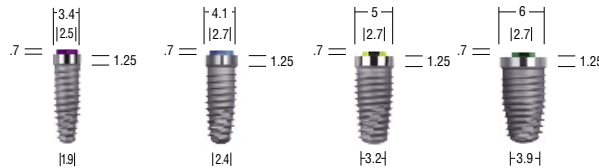

Length	3.25mm(D)	4mm(D)	5mm(D)	6mm(D)
8.5mm	NNT3285	NNT485	NNT585	NNT685
10mm	NNT3210	NNT410	NNT510	NNT610
11.5mm	NNT3211	NNT411	NNT511	NNT611
13mm	NNT3213	NNT413	NNT513	NNT613
15mm	NNT3215	NNT415	NNT515	NNT615

Cover Screw 1mm(H) (included)	MMCS1	CS375	CS500	CS600
Cover Screw Headless	CS275	CS275	CS275	CS275

All indicated measurements are in millimeters.

Some products may not be available outside of the United States. Algunos productos no se comercializan fuera de EE.UU. Certains produits ne sont pas disponibles en dehors des États-Unis. Einige Produkte sind außerhalb der USA nicht erhältlich.

External Hex Connection Implants

Tapered

Full OSSEOTITE® Tapered
Commercially Pure Titanium

Length	3.25mm(D)	4mm(D)	5mm(D)	6mm(D)
8.5mm	FNT3285	FNT485	FNT585	FNT685
10mm	FNT3210	FNT410	FNT510	FNT610
11.5mm	FNT3211	FNT411	FNT511	FNT611
13mm	FNT3213	FNT413	FNT513	FNT613
15mm	FNT3215	FNT415	FNT515	FNT615
Cover Screw 1mm(H) (included)	MMCS1	CS375	CS500	CS600
Cover Screw Headless	CS275	CS275	CS275	CS275

OSSEOTITE Tapered
Commercially Pure Titanium

Length	3.25mm(D)	4mm(D)	5mm(D)	6mm(D)
8.5mm	NT3285	NT485	NT585	NT685
10mm	NT3210	NT410	NT510	NT610
11.5mm	NT3211	NT411	NT511	NT611
13mm	NT3213	NT413	NT513	NT613
15mm	NT3215	NT415	NT515	NT615
Cover Screw 1mm(H) (included)	MMCS1	CS375	CS500	CS600
Cover Screw Headless	CS275	CS275	CS275	CS275





All indicated measurements are in millimeters.

Some products may not be available outside of the United States.
Algunos productos no se comercializan fuera de EE.UU.
Certains produits ne sont pas disponibles en dehors des États-Unis.
Einige Produkte sind außerhalb der USA nicht erhältlich.

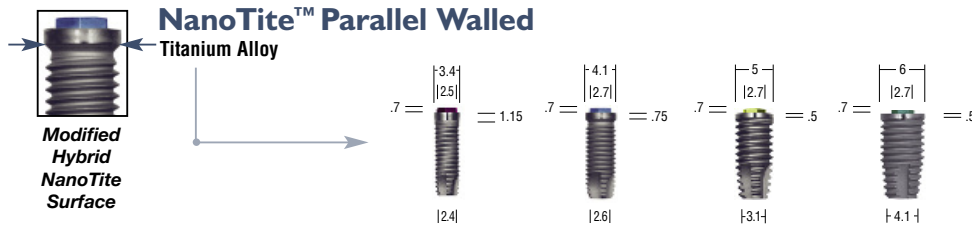



External Hex Connection Implants

Parallel Walled

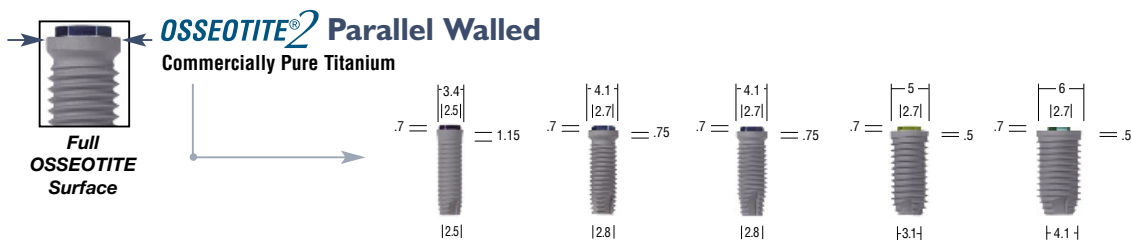

Length	3.25mm(D)	4mm(D)	5mm(D)	6mm(D)
7mm	N/A	NOSS407	NOSS507	NOSS607
8.5mm	NOSM385	NOSS485	NOSS585	NOSS685
10mm	NOSM310	NOSS410	NOSS510	NOSS610
11.5mm	NOSM311	NOSS411	NOSS511	NOSS611
13mm	NOSM313	NOSS413	NOSS513	NOSS613
15mm	NOSM315	NOSS415	NOSS515	NOSS615
18mm	NOSM318	NOSS418	NOSS518	NOSS618
Cover Screw 1mm(H) (included)	 MMCS1	 CS375	 CS500	 CS600
Cover Screw Headless	CS275	CS275	CS275	CS275



Length	3.25mm(D)	3.75mm(D)	4mm(D)	5mm(D)	6mm(D)
6.5mm	XFOSM365	XFOS365	XFOS465	XFOS565	XFOS665
8.5mm	XFOSM385	XFOS385	XFOS485	XFOS585	XFOS685
10mm	XFOSM310	XFOS310	XFOS410	XFOS510	XFOS610
11.5mm	XFOSM311	XFOS311	XFOS411	XFOS511	XFOS611
13mm	XFOSM313	XFOS313	XFOS413	XFOS513	XFOS613
15mm	XFOSM315	XFOS315	XFOS415	XFOS515	XFOS615
Cover Screw 1mm(H) (included)	 MMCS1	 CS375	 CS375	 CS500	 CS600
Cover Screw Headless	CS275	CS275	CS275	CS275	CS275

All indicated measurements are in millimeters.

Some products may not be available outside of the United States.
 Algunos productos no se comercializan fuera de EE.UU.
 Certains produits ne sont pas disponibles en dehors des États-Unis.
 Einige Produkte sind außerhalb der USA nicht erhältlich.

External Hex Connection Implants

Parallel Walled

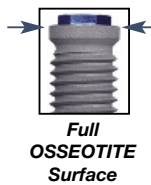

Full OSSEOTITE® Parallel Walled

Commercially Pure Titanium

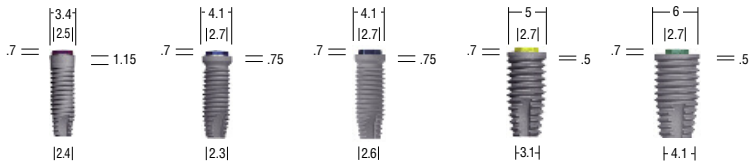

Length	3.25mm(D)	3.75mm(D)	4mm(D)	5mm(D)	6mm(D)
7mm	FOSM307	FOS307	FOS407	FOS507	FOS607
8.5mm	FOSM385	FOS385	FOS485	FOS585	FOS685
10mm	FOSM310	FOS310	FOS410	FOS510	FOS610
11.5mm	FOSM311	FOS311	FOS411	FOS511	FOS611
13mm	FOSM313	FOS313	FOS413	FOS513	FOS613
15mm	FOSM315	FOS315	FOS415	FOS515	FOS615
Cover Screw 1mm(H) (included)					
	MMCS1	CS375	CS375	CS500	CS600
Cover Screw Headless	CS275	CS275	CS275	CS275	CS275

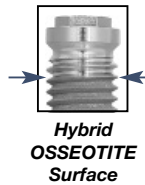

OSSEOTITE Parallel Walled

Commercially Pure Titanium

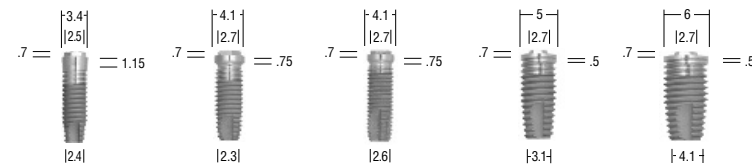

Length	3.25mm(D)	3.75mm(D)	4mm(D)	5mm(D)	6mm(D)
7mm	N/A	N/A	N/A	OSS507	OSS607
8.5mm	OSM385	OSS385	OSS485	OSS585	OSS685
10mm	OSM310	OSS310	OSS410	OSS510	OSS610
11.5mm	OSM311	OSS311	OSS411	OSS511	OSS611
13mm	OSM313	OSS313	OSS413	OSS513	OSS613
15mm	OSM315	OSS315	OSS415	OSS515	OSS615
18mm	OSM318	OSS318	OSS418	OSS518	OSS618
20mm	N/A	OSS320	OSS420	N/A	N/A
Cover Screw 1mm(H) (included)					
	MMCS1	CS375	CS375	CS500	CS600
Cover Screw Headless	CS275	CS275	CS275	CS275	CS275

All indicated measurements are in millimeters.

Some products may not be available outside of the United States.
 Algunos productos no se comercializan fuera de EE.UU.
 Certains produits ne sont pas disponibles en dehors des États-Unis.
 Einige Produkte sind außerhalb der USA nicht erhältlich.

Healing Abutments

Certain® Internal Connection



The **BellaTek® Encode® Impression System** eliminates the need for an implant-level impression while delivering a patient specific restoration with appropriate margin height and natural emergence contours for the patient. This accuracy is achieved from an impression of the BellaTek Encode Healing Abutment.

Codes embedded on the occlusal surface of the BellaTek Encode Healing Abutment communicate the collar height, implant hex orientation, platform diameter and interface (the Certain Internal Connection or External Hex Connection) of the implant.

Because the tissue is healed at the time of impression, the margin should have the appropriate placement and contour. The result is a patient specific, anatomically designed, final BellaTek Encode Abutment. Available in titanium or with titanium nitride coating.

Optimization Is Key To Bellatek Digital Dentistry Solutions

- *Hard- And Soft-Tissue Maintenance*
- *Customized Treatment Solutions*
- *Practice Growth*

Healing Abutments

Certain® Internal Connection

BellaTek

Encode® Two-Piece



Occlusal markings provide scanner information for abutment design.

3.4mm(D) Seating Surface



Emergence Profile	Collar Height	Item Numbers
3.8mm	3mm	IEHA343
3.8mm	4mm	IEHA344
3.8mm	6mm	IEHA346
3.8mm	8mm	IEHA348
5mm	3mm	IEHA353
5mm	4mm	IEHA354
5mm	6mm	IEHA356
5mm	8mm	IEHA358

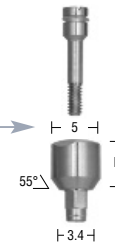

4.1mm(D) Seating Surface

Emergence Profile	Collar Height	Item Numbers
4.1mm	3mm	IEHA443
4.1mm	4mm	IEHA444
4.1mm	6mm	IEHA446
4.1mm	8mm	IEHA448
5mm	3mm	IEHA453
5mm	4mm	IEHA454
5mm	6mm	IEHA456
5mm	8mm	IEHA458
6mm	3mm	IEHA463
6mm	4mm	IEHA464
6mm	6mm	IEHA466
6mm	8mm	IEHA468

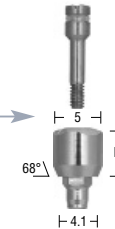

5mm(D) Seating Surface

Emergence Profile	Collar Height	Item Numbers
5.6mm	3mm	IEHA553
5.6mm	4mm	IEHA554
5.6mm	6mm	IEHA556
5.6mm	8mm	IEHA558
6mm	3mm	IEHA563
6mm	4mm	IEHA564
6mm	6mm	IEHA566
6mm	8mm	IEHA568

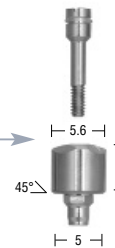

6mm(D) Seating Surface

Emergence Profile	Collar Height	Item Numbers
6.8mm	3mm	IEHA663
6.8mm	4mm	IEHA664
6.8mm	6mm	IEHA666
6.8mm	8mm	IEHA668

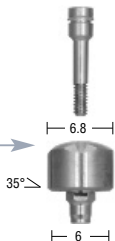

All indicated measurements are in millimeters.

Some products may not be available outside of the United States.
 Algunos productos no se comercializan fuera de EE.UU.
 Certains produits ne sont pas disponibles en dehors des États-Unis.
 Einige Produkte sind außerhalb der USA nicht erhältlich.

BIOMET 3i
 PROVIDING SOLUTIONS – ONE PATIENT AT A TIME™

Healing Abutments

Certain® Internal Connection

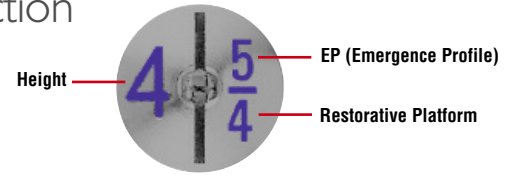

EP® One-Piece

3.4mm(D) Seating Surface

Emergence Profile	Collar Height	Item Numbers
3.4mm	2mm	ISMHA32
3.4mm	3mm	ISMHA33
3.4mm	4mm	ISMHA34
3.4mm	6mm	ISMHA36
3.8mm	2mm	IMHA32
3.8mm	3mm	IMHA33
3.8mm	4mm	IMHA34
3.8mm	6mm	IMHA36
5mm	2mm	IMHA352
5mm	3mm	IMHA353
5mm	4mm	IMHA354
5mm	6mm	IMHA356

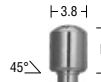
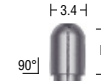

4.1mm(D) Seating Surface

Emergence Profile	Collar Height	Item Numbers
4.1mm	2mm	ISHA42
4.1mm	3mm	ISHA43
4.1mm	4mm	ISHA44
4.1mm	6mm	ISHA46
4.1mm	8mm	ISHA48
5mm	2mm	ITHA52
5mm	3mm	ITHA53
5mm	4mm	ITHA54
5mm	6mm	ITHA56
5mm	8mm	ITHA58
6mm	3mm	ITHA63
6mm	4mm	ITHA64
6mm	6mm	ITHA66
6mm	8mm	ITHA68

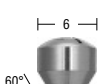
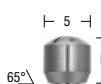
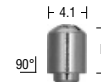

All indicated measurements are in millimeters.

Some products may not be available outside of the United States.
Algunos productos no se comercializan fuera de EE.UU.
Certains produits ne sont pas disponibles en dehors des États-Unis.
Einige Produkte sind außerhalb der USA nicht erhältlich.

Healing Abutments

Certain® Internal Connection

EP® One-Piece

5mm(D) Seating Surface		
Emergence Profile	Collar Height	Item Numbers
5mm	2mm	ISWHA52
5mm	3mm	ISWHA53
5mm	4mm	ISWHA54
5mm	6mm	ISWHA56
5mm	8mm	ISWHA58
5.6mm	2mm	IWTH52
5.6mm	3mm	IWTH53
5.6mm	4mm	IWTH54
5.6mm	6mm	IWTH56
5.6mm	8mm	IWTH58
6mm	2mm	IWTH562
6mm	3mm	IWTH563
6mm	4mm	IWTH564
6mm	6mm	IWTH566
6mm	8mm	IWTH568

6mm(D) Seating Surface		
Emergence Profile	Collar Height	Item Numbers
6mm	2mm	ISWHA62
6mm	3mm	ISWHA63
6mm	4mm	ISWHA64
6mm	6mm	ISWHA66
6mm	8mm	ISWHA68
6.8mm	2mm	IWTH62
6.8mm	3mm	IWTH63
6.8mm	4mm	IWTH64
6.8mm	6mm	IWTH66
6.8mm	8mm	IWTH68

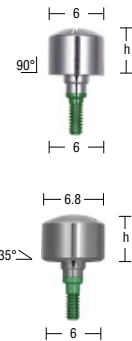
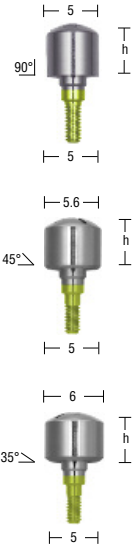

All indicated measurements are in millimeters.

Some products may not be available outside of the United States.
 Algunos productos no se comercializan fuera de EE.UU.
 Certains produits ne sont pas disponibles en dehors des États-Unis.
 Einige Produkte sind außerhalb der USA nicht erhältlich.

Healing Abutments

External Hex Connection



Encode® Two-Piece



Occlusal markings provide scanner information for abutment design.

3.4mm(D) Seating Surface



Emergence Profile	Collar Height	Item Numbers
3.8mm	3mm	EHA343
3.8mm	4mm	EHA344
3.8mm	6mm	EHA346
3.8mm	8mm	EHA348
5mm	3mm	EHA353
5mm	4mm	EHA354
5mm	6mm	EHA356
5mm	8mm	EHA358

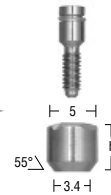

4.1mm(D) Seating Surface

Emergence Profile	Collar Height	Item Numbers
4.1mm	3mm	EHA443
4.1mm	4mm	EHA444
4.1mm	6mm	EHA446
4.1mm	8mm	EHA448
5mm	3mm	EHA453
5mm	4mm	EHA454
5mm	6mm	EHA456
5mm	8mm	EHA458
6mm	3mm	EHA463
6mm	4mm	EHA464
6mm	6mm	EHA466
6mm	8mm	EHA468

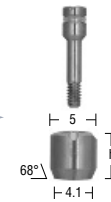

5mm(D) Seating Surface

Emergence Profile	Collar Height	Item Numbers
5.6mm	3mm	EHA553
5.6mm	4mm	EHA554
5.6mm	6mm	EHA556
5.6mm	8mm	EHA558
6mm	3mm	EHA563
6mm	4mm	EHA564
6mm	6mm	EHA566
6mm	8mm	EHA568

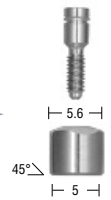

6mm(D) Seating Surface

Emergence Profile	Collar Height	Item Numbers
6.8mm	3mm	EHA663
6.8mm	4mm	EHA664
6.8mm	6mm	EHA666
6.8mm	8mm	EHA668

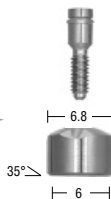

All indicated measurements are in millimeters.

Some products may not be available outside of the United States.
 Algunos productos no se comercializan fuera de EE.UU.
 Certains produits ne sont pas disponibles en dehors des États-Unis.
 Einige Produkte sind außerhalb der USA nicht erhältlich.

Healing Abutments

External Hex Connection

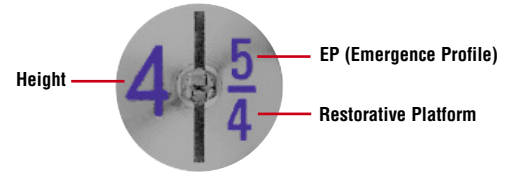

EP® One-Piece

3.4mm(D) Seating Surface

Emergence Profile	Collar Height	Item Numbers
3.8mm	2mm	MHA32
3.8mm	3mm	MHA33
3.8mm	4mm	MHA34
3.8mm	6mm	MHA36

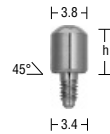

4.1mm(D) Seating Surface

Emergence Profile	Collar Height	Item Numbers
4.1mm	2mm	THA42
4.1mm	3mm	THA43
4.1mm	4mm	THA44
4.1mm	6mm	THA46
4.1mm	8mm	THA48
5mm	2mm	THA52
5mm	3mm	THA53
5mm	4mm	THA54
5mm	6mm	THA56
5mm	8mm	THA58
6mm	3mm	THA63
6mm	4mm	THA64
6mm	6mm	THA66
6mm	8mm	THA68

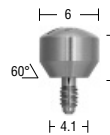
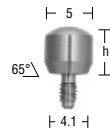
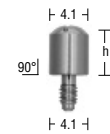

5mm(D) Seating Surface

Emergence Profile	Collar Height	Item Numbers
5.6mm	2mm	WTH52
5.6mm	3mm	WTH53
5.6mm	4mm	WTH54
5.6mm	6mm	WTH56
5.6mm	8mm	WTH58
6mm	2mm	WTH562
6mm	3mm	WTH563
6mm	4mm	WTH564
6mm	6mm	WTH566
6mm	8mm	WTH568

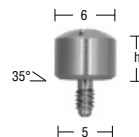
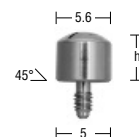

6mm(D) Seating Surface

Emergence Profile	Collar Height	Item Numbers
6.8mm	2mm	WTH62
6.8mm	3mm	WTH63
6.8mm	4mm	WTH64
6.8mm	6mm	WTH66
6.8mm	8mm	WTH68

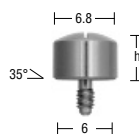

Temporary Healing Retention Cylinder

Retains denture with soft tissue liner.

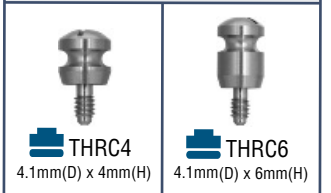

All indicated measurements are in millimeters.

Some products may not be available outside of the United States.
Algunos productos no se comercializan fuera de EE.UU.
Certains produits ne sont pas disponibles en dehors des États-Unis.
Einige Produkte sind außerhalb der USA nicht erhältlich.

Site Preparation Technologies

Product Overview

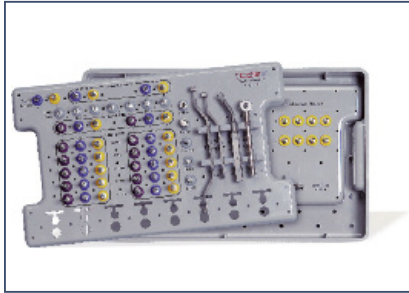

Tapered Navigator Surgical Kit



Parallel Walled Navigator Surgical Kit



DU1000 Surgical Drilling Unit



OSSEOCISION Surgical Drilling Unit

The Navigator® System For Guided Surgery

The Navigator System helps clinicians transform computer-based planning into practical implant placement with an opportunity for immediate provisionalization.

The Navigator System enables placement and restoration of the following **COMET 3i** Tapered and Parallel Walled Implant Systems:

- Tapered/Parallel Walled Certain® 3.25, 4 and 5mm Implants
- Certain PREVAIL® 3/4/3, 4/3, 4/5/4 and 5/4 Implants
- Certain Tapered PREVAIL 4/3 and 5/4 Implants

Features specific to the Navigator System include:

- Depth-specific instrumentation for preparation and implant placement
- Control of hex-orientation to fabricate and deliver provisional restorations immediately following implant placement
- Open architecture compatibility that provides freedom to choose among leading planning software solutions

DU1000 & OSSEOCISION® Surgical Drilling Units

Both DU1000 and OSSEOCISION Surgical Drilling Units accept twist drills, shaping drills and implant drivers. The units power these instruments in order to create the osteotomy for implant placement.

- Ergonomic handpiece design
- Customized programs for every stage of dental implant surgical procedures
- Foot control for hands-free program and setting selections

DU1000 is manufactured by W&H Dentalwerk Bürmoos GmbH .

OSSEOCISION is manufactured by NSK Nakanishi Inc.

Site Preparation Technologies

Product Overview



Advanced Cutting Technology[®] (ACT[®]) Drills

- Two-flute design for efficient cutting
- Alternating lines and bands enhance depth mark visibility and drill orientation in the osteotomy
- Matte finish to reduce glare



Tapered Implant Depth Indicators & Quad Shaping Drills

- Tapered Implant Depth Indicators (NTDIs) verify the position of the implant platform prior to placement
- Quad Shaping Drills (QSDs) use stepped depth marks for accuracy in creating the osteotomy
- QSDs have end cutting ability
- Both QSDs and NTDIs are color-coded for platform recognition



Summers Osteotomes & Tapered Osteotomes

- Summers Osteotomes for use with parallel walled implants
- Tapered Osteotomes available in straight and angled designs for use with tapered implants
- Matte finished tip surface to reduce glare
- Ball striking end to facilitate use of a mallet



High Torque Indicating Ratchet Wrench (H-TIRW)

- The H-TIRW doubles as a conventional ratchet wrench to place implants and as a torque indicator to provide a visual assessment of torque.
- Clearly indicates forward and reverse torque of 50-90Ncm without the need for additional components.
- Does not require lubrication or periodic re-calibration. Calibration may be checked by verifying that the arrow is positioned at the first scale mark (0Ncm).
- Consisting of only two parts, the H-TIRW is easy to prepare for sterilization.

Site Preparation Technologies



DU1000 Surgical Drilling Unit

Description	Item Numbers
DU1000 Surgical Drilling Unit 115 volt 230 volt	DU1000US DU1000EU*
Accessories Included With The DU1000:	All accessories listed are compatible with both the DU900 and DU1000 except for DU1KMC, DU1KHS, DU1KFC and DU1KH1.
Micromotor With Cable - 1.8m/5.9ft motor cable plugs into console and attaches to handpiece	DU1KMC
Motor/Handpiece Support - Drill unit attachment for resting handpiece	DU1KHS
Foot Control - Ergonomic design, variable speed and connects to console to provide foot activation	DU1KFC
Handle For Foot Control - Foot control attachment allowing for repositioning of foot control	DU1KH1
Irrigation Bag Stand - Stand for irrigation solution bag	DU9IBS
Circuit Fuse - Fuse for console, T1.25AH (250 volt)	DU9F
Motor Protective Cover - Component placed over the end of a DU1KMC before cleaning and disinfection and for sterilization in sterilizers without a drying program	DU9SP
Locking Pin - Prevents handpiece on the motor attachment from turning during transmission	DU9LP
Disposable Irrigation Tubing Set (6-piece) - For the supply of irrigation fluid	DU1KIT
Spray Cap With Nozzle - Spray cap for service oil	DU9SC
Bur Testing Gauge - Verifies bur/drill shank diameter	DU9BG
Irrigation Tube Clamps (5-pack) - Clamps holding irrigation tubing to motor cable (DU9MC)	DU9CL
Electrical Power Cord (United States, Canada, Japan) - Connects to console and appropriate wall outlet	DU9PCUS
Electrical Power Cord (European Union) - Connects to console and appropriate wall outlet	DU9PCEU*
Electrical Power Cord (Switzerland) - Connects to console and appropriate wall outlet	DU1KPCCH*
Electrical Power Cord (Denmark) - Connects to console and appropriate wall outlet	DU1KPCDK*
Electrical Power Cord (United Kingdom, Ireland) - Connects to console and appropriate wall outlet	DU9PCUK*
Electrical Power Cord (Australia, New Zealand) - Connects to console and appropriate wall outlet	DU9PCAU*

The following items are not included with the DU1000 Surgical Drilling Unit, but can be ordered separately through  Customer Service.

20:1 Handpiece - WS-75 E/KM Gear reduction handpiece	DU9WS75
20:1 Handpiece - WI-75 LED G Gear reduction handpiece with built-in LED light	DU9WI75L
Nozzle Cleaner - Cleans coolant outlets of handpieces; included with handpiece	DU9NC
Y-Connector (3-pack) - Used to bifurcate irrigate flow from irrigation tube, DU1KIT, to provide both internal and external irrigation; included with handpiece	DU9YC

*Not available in the United States.

Some products may not be available outside of the United States.
Algunos productos no se comercializan fuera de EE.UU.
Certains produits ne sont pas disponibles en dehors des États-Unis.
Einige Produkte sind außerhalb der USA nicht erhältlich.

Site Preparation Technologies



OSSEOCISION® Surgical Drilling Unit

Description	Item Numbers
OSSEOCISION Surgical Drilling Unit	
120 volt	DS100US
100 volt	DS100J*
230 volt	DS100RW*

Accessories Included With The OSSEOCISION Surgical Drilling Unit:

Tube Clamp - Holds irrigation tubing to motor cord	C202-750
Internal Irrigation Tube - "L" shaped tube that fits through the handpiece head and connects the irrigation tubing and an internally irrigated component	C293-025
Y-Connector - Used to bifurcate irrigate flow from irrigation tube to provide both internal and external irrigation	C823-752
Micromotor With Cord - Plugs into DS100 Console and attaches to handpiece	E211-001
Autoclave Plug For Motor - Used to keep moisture from entering micromotor during sterilization	E211-701
20:1 Handpiece - 20:1 Gear Reduction Handpiece for the drilling unit	SGQ-ER20H
Fuse (100V/120V) - Circuit fuse for DS100 Console (110–130 volt)	U195-152
Fuse (230V) - Circuit fuse for DS100 Console (230 volt)	U197-152*
Coolant Solution Hanger Post - Suspends irrigation bag or bottle from console	U370-152
Control Unit (100V) - DS100J Console	U370-003*
Control Unit (120V) - DS100US Console	U371-003
Control Unit (230V) - DS100RW Console	U372-003*
Electrical Power Cord (100V) - Plugs into DS100J Console and appropriate wall outlet	U389-013*
Electrical Power Cord (120V) - Plugs into DS100US Console and appropriate wall outlet	U371-550
Electrical Power Cord (230V Europe) - Plugs into DS100RW Console and appropriate wall outlet	U260-414*
Electrical Power Cord (230V Australia) - Plugs into DS100RW Console and appropriate wall outlet	U198-013*
Irrigation Tube Holder - Holds irrigation tubing to handpiece	Y900-083
Irrigation Tubing, Disposable/Clear (5-pack) - Connects between irrigation bag or bottle and handpiece to provide irrigation flow	For re-ordering, refer to Y900-114.
Motor Cradle - Supports handpiece when not in use	Z095-102
Handpiece Wench - Used to disassemble handpiece	Z103-101
Spray Lubricant Nozzle - Attaches to lubricant to lubricate handpiece	Z114-090
Nozzle Cleaning Fine Wire - Used to clean handpiece irrigation tube	Z144-095
Foot Control (3.5m) - Connects to DS100 Console to provide foot activation	Z272-004

The following items are not included in the OSSEOCISION Surgical Drilling Unit, but can be ordered separately through **BIOMET 3i Customer Service**.

Motor Cord - Plugs into DS100 Console and attaches to handpiece	E211-051
Irrigation Tubing, Disposable/Clear (10-pack) - Connects between irrigation bag or bottle and handpiece to provide irrigation flow	Y900-114

*Not available in the United States.

Refer to ART984 for the OSSEOCISION Warranty.

Some products may not be available outside of the United States.
 Algunos productos no se comercializan fuera de EE.UU.
 Certains produits ne sont pas disponibles en dehors des États-Unis.
 Einige Produkte sind außerhalb der USA nicht erhältlich.

BIOMET 3i
 PROVIDING SOLUTIONS – ONE PATIENT AT A TIME™

Site Preparation Technologies

Tapered Navigator® System For Guided Surgery

SGTIKIT Tapered Navigator Surgical Kit

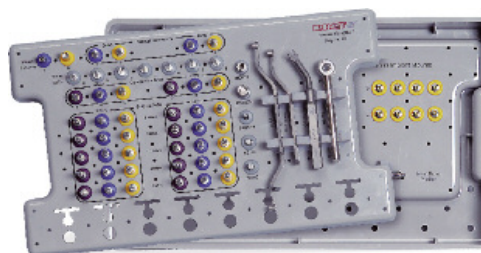

For Tapered Implants Including:

- Tapered Certain® 3.25, 4 and 5mm Implants
- Tapered PREVAIL® 4/3 and 5/4 Implants

		
SGTIKIT Surgical Kit	Description	Item Numbers
•	Tapered Navigator Surgical Tray	SGTTRAY
•	Tapered Navigator Tissue Punch, 4.1mm(D)	SGTTP4
•	Tapered Navigator Tissue Punch, 5mm(D)	SGTTP5
•	Tapered Navigator Cortical Perforator, 4.1mm(D) - Short	SGTCP4S
•	Tapered Navigator Cortical Perforator, 4.1mm(D) - Long	SGTCP4L
•	Tapered Navigator Cortical Perforator, 5mm(D) - Short	SGTCP5S
•	Tapered Navigator Cortical Perforator, 5mm(D) - Long	SGTCP5L
•	Tapered Navigator Twist Drill, 1.9mm(D) x A(L)	SGTD19A
•	Tapered Navigator Twist Drill, 1.9mm(D) x B(L)	SGTD19B
•	Tapered Navigator Twist Drill, 1.9mm(D) x C(L)	SGTD19C
•	Tapered Navigator Twist Drill, 1.9mm(D) x D(L)	SGTD19D
•	Tapered Navigator Twist Drill, 1.9mm(D) x E(L)	SGTD19E
•	Tapered Navigator Twist Drill, 1.9mm(D) x F(L)	SGTD19F
•	Tapered Navigator Twist Drill, 1.9mm(D) x G(L)	SGTD19G
•	Tapered Navigator Countersink Drill, 3.4mm(D) - Short	MSGTCD5
•	Tapered Navigator Countersink Drill, 4.1mm(D) - Short	SGTCD4S
•	Tapered Navigator Countersink Drill, 5mm(D) - Short	SGTCD5S
•	Tapered Navigator Countersink Drill, 3.4mm(D) - Long	MSGTCDL
•	Tapered Navigator Countersink Drill, 4.1mm(D) - Long	SGTCD4L
•	Tapered Navigator Countersink Drill, 5mm(D) - Long	SGTCD5L
•	Tapered Navigator Shaping Drill, 3.25mm(D) x 8.5mm(L) - Short	MSGTD85S
•	Tapered Navigator Shaping Drill, 3.25mm(D) x 10mm(L) - Short	MSGTD10S
•	Tapered Navigator Shaping Drill, 3.25mm(D) x 11.5mm(L) - Short	MSGTD11S
•	Tapered Navigator Shaping Drill, 3.25mm(D) x 13mm(L) - Short	MSGTD13S
•	Tapered Navigator Shaping Drill, 3.25mm(D) x 15mm(L) - Short	MSGTD15S
•	Tapered Navigator Shaping Drill, 4.1mm(D) x 8.5mm(L) - Short	SGTD485S
•	Tapered Navigator Shaping Drill, 4.1mm(D) x 10mm(L) - Short	SGTD410S
•	Tapered Navigator Shaping Drill, 4.1mm(D) x 11.5mm(L) - Short	SGTD411S
•	Tapered Navigator Shaping Drill, 4.1mm(D) x 13mm(L) - Short	SGTD413S
•	Tapered Navigator Shaping Drill, 4.1mm(D) x 15mm(L) - Short	SGTD415S
•	Tapered Navigator Shaping Drill, 5mm(D) x 8.5mm(L) - Short	SGTD585S

Some products may not be available outside of the United States.
 Algunos productos no se comercializan fuera de EE.UU.
 Certains produits ne sont pas disponibles en dehors des États-Unis.
 Einige Produkte sind außerhalb der USA nicht erhältlich.

Site Preparation Technologies

Surgical Kit Cont'd

	Description	Item Numbers
•	Tapered Navigator® Shaping Drill, 5mm(D) x 10mm(L) - Short	SGTD510S
•	Tapered Navigator Shaping Drill, 5mm(D) x 11.5mm(L) - Short	SGTD511S
•	Tapered Navigator Shaping Drill, 5mm(D) x 13mm(L) - Short	SGTD513S
•	Tapered Navigator Shaping Drill, 5mm(D) x 15mm(L) - Short	SGTD515S
•	Tapered Navigator Shaping Drill, 3.25mm(D) x 8.5mm(L) - Long	MSGTD85L
•	Tapered Navigator Shaping Drill, 3.25mm(D) x 10mm(L) - Long	MSGTD10L
•	Tapered Navigator Shaping Drill, 3.25mm(D) x 11.5mm(L) - Long	MSGTD11L
•	Tapered Navigator Shaping Drill, 3.25mm(D) x 13mm(L) - Long	MSGTD13L
•	Tapered Navigator Shaping Drill, 3.25mm(D) x 15mm(L) - Long	MSGTD15L
•	Tapered Navigator Shaping Drill, 4.1mm(D) x 8.5mm(L) - Long	SGTD485L
•	Tapered Navigator Shaping Drill, 4.1mm(D) x 10mm(L) - Long	SGTD410L
•	Tapered Navigator Shaping Drill, 4.1mm(D) x 11.5mm(L) - Long	SGTD411L
•	Tapered Navigator Shaping Drill, 4.1mm(D) x 13mm(L) - Long	SGTD413L
•	Tapered Navigator Shaping Drill, 4.1mm(D) x 15mm(L) - Long	SGTD415L
•	Tapered Navigator Shaping Drill, 5mm(D) x 8.5mm(L) - Long	SGTD585L
•	Tapered Navigator Shaping Drill, 5mm(D) x 10mm(L) - Long	SGTD510L
•	Tapered Navigator Shaping Drill, 5mm(D) x 11.5mm(L) - Long	SGTD511L
•	Tapered Navigator Shaping Drill, 5mm(D) x 13mm(L) - Long	SGTD513L
•	Tapered Navigator Shaping Drill, 5mm(D) x 15mm(L) - Long	SGTD515L
•	Tapered Navigator Twist Drill Positioning Handle	SGTDPHT
•	Tapered Navigator Reduction Drill Positioning Handle	SGTDPHR
•	Handpiece Connector	MDR10
•	Narrow Right Angle Large Hexed Driver Tip, 24mm(L)	RASH3N
•	Posterior Large Hexed Driver, 17mm(L)	PHD02N
•	Ratchet Extension, 6mm(L) - Short	RE100
•	Ratchet Extension, 15mm(L) - Long	RE200
•	Ratchet Wrench	WR150
•	Open End Wrench	CW100
•	Navigator Certain® Implant Mount, 3.4mm(D) - Short	MSGIIMS
•	Navigator Certain Implant Mount, 3.4mm(D) - Long	MSGIIML
•	Navigator Certain Implant Mount, 4.1mm(D) - Short	SGIIM4S
•	Navigator Certain Implant Mount, 4.1mm(D) - Long	SGIIM4L
•	Navigator Certain Implant Mount, 5mm(D) - Short	SGIIM5S
•	Navigator Certain Implant Mount, 5mm(D) - Long	SGIIM5L
•	Certain Manual Bone Profiler, 3.4mm(D) x 4.1mm(P)	IMMBP
•	Certain Manual Bone Profiler, 4.1mm(D) x 5mm(P)	IMBP4
•	Certain Manual Bone Profiler, 5mm(D) x 6mm(P)	IMBP5

Some products may not be available outside of the United States.
 Algunos productos no se comercializan fuera de EE.UU.
 Certains produits ne sont pas disponibles en dehors des États-Unis.
 Einige Produkte sind außerhalb der USA nicht erhältlich.

Site Preparation Technologies

Tapered Navigator® System For Guided Surgery

For Tapered Implants Including:

- Certain® 3.25, 4 and 5mm Implants
- Tapered PREVAIL® 4/3 and 5/4 Implants

Tapered Navigator Tap Kit (Included under SGTIKIT)



SGTIKIT Surgical Kit	Description	Item Numbers
•	Tapered Navigator Bone Tap Tray	SGTTAPT
•	Tapered Navigator Bone Tap, 3.25mm(D) x 8.5mm(L) - Short	MSGTT85S
•	Tapered Navigator Bone Tap, 3.25mm(D) x 10mm(L) - Short	MSGTT10S
•	Tapered Navigator Bone Tap, 3.25mm(D) x 11.5mm(L) - Short	MSGTT11S
•	Tapered Navigator Bone Tap, 3.25mm(D) x 13mm(L) - Short	MSGTT13S
•	Tapered Navigator Bone Tap, 3.25mm(D) x 15mm(L) - Short	MSGTT15S
•	Tapered Navigator Bone Tap, 4.1mm(D) x 8.5mm(L) - Short	SGTT485S
•	Tapered Navigator Bone Tap, 4.1mm(D) x 10mm(L) - Short	SGTT410S
•	Tapered Navigator Bone Tap, 4.1mm(D) x 11.5mm(L) - Short	SGTT411S
•	Tapered Navigator Bone Tap, 4.1mm(D) x 13mm(L) - Short	SGTT413S
•	Tapered Navigator Bone Tap, 4.1mm(D) x 15mm(L) - Short	SGTT415S
•	Tapered Navigator Bone Tap, 5mm(D) x 8.5mm(L) - Short	SGTT585S
•	Tapered Navigator Bone Tap, 5mm(D) x 10mm(L) - Short	SGTT510S
•	Tapered Navigator Bone Tap, 5mm(D) x 11.5mm(L) - Short	SGTT511S
•	Tapered Navigator Bone Tap, 5mm(D) x 13mm(L) - Short	SGTT513S
•	Tapered Navigator Bone Tap, 5mm(D) x 15mm(L) - Short	SGTT515S
•	Tapered Navigator Bone Tap, 3.25mm(D) x 8.5mm(L) - Long	MSGTT85L
•	Tapered Navigator Bone Tap, 3.25mm(D) x 10mm(L) - Long	MSGTT10L
•	Tapered Navigator Bone Tap, 3.25mm(D) x 11.5mm(L) - Long	MSGTT11L
•	Tapered Navigator Bone Tap, 3.25mm(D) x 13mm(L) - Long	MSGTT13L
•	Tapered Navigator Bone Tap, 3.25mm(D) x 15mm(L) - Long	MSGTT15L
•	Tapered Navigator Bone Tap, 4.1mm(D) x 8.5mm(L) - Long	SGTT485L
•	Tapered Navigator Bone Tap, 4.1mm(D) x 10mm(L) - Long	SGTT410L
•	Tapered Navigator Bone Tap, 4.1mm(D) x 11.5mm(L) - Long	SGTT411L
•	Tapered Navigator Bone Tap, 4.1mm(D) x 13mm(L) - Long	SGTT413L
•	Tapered Navigator Bone Tap, 4.1mm(D) x 15mm(L) - Long	SGTT415L
•	Tapered Navigator Bone Tap, 5mm(D) x 8.5mm(L) - Long	SGTT585L
•	Tapered Navigator Bone Tap, 5mm(D) x 10mm(L) - Long	SGTT510L
•	Tapered Navigator Bone Tap, 5mm(D) x 11.5mm(L) - Long	SGTT511L
•	Tapered Navigator Bone Tap, 5mm(D) x 13mm(L) - Long	SGTT513L
•	Tapered Navigator Bone Tap, 5mm(D) x 15mm(L) - Long	SGTT515L

Some products may not be available outside of the United States.
 Algunos productos no se comercializan fuera de EE.UU.
 Certains produits ne sont pas disponibles en dehors des États-Unis.
 Einige Produkte sind außerhalb der USA nicht erhältlich.

Site Preparation Technologies

Tapered Navigator® System For Guided Surgery

SGTILKIT Tapered Navigator Laboratory Kit



For Tapered Implants Including:

- Certain® 3.25, 4 and 5mm Implants
- Tapered PREVAIL® 4/3 and 5/4 Implants

		
SGTILKIT Surgical Kit	<i>Description</i>	<i>Item Numbers</i>
•	Tapered Navigator Laboratory Tray	SGTLTRAY
•	Navigator Certain Analog Mount, 3.4mm(D) - Short	MSGIAMS
•	Navigator Certain Analog Mount, 4.1mm(D) - Short	SGIAM4S
•	Navigator Certain Analog Mount, 5mm(D) - Short	SGIAM5S
•	Navigator Certain Analog Mount, 3.4mm(D) - Long	MSGIAML
•	Navigator Certain Analog Mount, 4.1mm(D) - Long	SGIAM4L
•	Navigator Certain Analog Mount, 5mm(D) - Long	SGIAM5L

Some products may not be available outside of the United States.
 Algunos productos no se comercializan fuera de EE.UU.
 Certains produits ne sont pas disponibles en dehors des États-Unis.
 Einige Produkte sind außerhalb der USA nicht erhältlich.

Site Preparation Technologies

Parallel Walled Navigator® System For Guided Surgery

SGKIT Navigator Parallel Walled Surgical Kit



For Parallel Walled Implants Including:

- Certain® 3.25, 4 and 5mm Implants
- PREVAIL® 3/4/3 and 4/5/4 Implants
- OSSEOTITE XP® 4/5 Implants
- Straight PREVAIL 4/3 and 5/4 Implants

		
SGKIT Surgical Kit	Description	Item Numbers
•	Navigator Surgical Tray	SGTRAY
•	Navigator Tissue Punch, 4.1mm(D)	SGTP4
•	Navigator Tissue Punch, 5mm(D)	SGTP5
•	Navigator Starter Drill, 3.4mm(D)	MSGSD
•	Navigator Starter Drill, 3/4mm(D)	SGSD34
•	Navigator Starter Drill, 4.1mm(D)	SGSD4
•	Navigator Starter Drill, 4/5mm(D)	SGSD45
•	Navigator Certain Starter Drill, 5mm(D)	SGISD5
•	Navigator Twist Drill, 2mm(D) x A(L)	SGD2A
•	Navigator Twist Drill, 2mm(D) x B(L)	SGD2B
•	Navigator Twist Drill, 2mm(D) x C(L)	SGD2C
•	Navigator Twist Drill, 2mm(D) x D(L)	SGD2D
•	Navigator Twist Drill, 2mm(D) x E(L)	SGD2E
•	Navigator Twist Drill, 2.75mm(D) x A(L)	SGD275A
•	Navigator Twist Drill, 2.75mm(D) x B(L)	SGD275B
•	Navigator Twist Drill, 2.75mm(D) x C(L)	SGD275C
•	Navigator Twist Drill, 2.75mm(D) x D(L)	SGD275D
•	Navigator Twist Drill, 2.75mm(D) x E(L)	SGD275E
•	Navigator Twist Drill, 3mm(D) x A(L)	SGD3A
•	Navigator Twist Drill, 3mm(D) x B(L)	SGD3B
•	Navigator Twist Drill, 3mm(D) x C(L)	SGD3C
•	Navigator Twist Drill, 3mm(D) x D(L)	SGD3D
•	Navigator Twist Drill, 3mm(D) x E(L)	SGD3E
•	Navigator Twist Drill, 3.25mm(D) x A(L)	SGD325A
•	Navigator Twist Drill, 3.25mm(D) x B(L)	SGD325B
•	Navigator Twist Drill, 3.25mm(D) x C(L)	SGD325C
•	Navigator Twist Drill, 3.25mm(D) x D(L)	SGD325D
•	Navigator Twist Drill, 3.25mm(D) x E(L)	SGD325E
•	Navigator Twist Drill, 3.85mm(D) x A(L)	SGD385A
•	Navigator Twist Drill, 3.85mm(D) x B(L)	SGD385B
•	Navigator Twist Drill, 3.85mm(D) x C(L)	SGD385C
•	Navigator Twist Drill, 4.25mm(D) x A(L)	SGD425A

Some products may not be available outside of the United States.
 Algunos productos no se comercializan fuera de EE.UU.
 Certains produits ne sont pas disponibles en dehors des États-Unis.
 Einige Produkte sind außerhalb der USA nicht erhältlich.

Site Preparation Technologies

Surgical Kit Cont'd

 SGKIT Surgical Kit	Description	Item Numbers
•	Navigator® Twist Drill, 4.25mm(D) x B(L)	SGD425B
•	Navigator Twist Drill, 4.25mm(D) x C(L)	SGD425C
•	Navigator Bone Tap, 3.25mm(D)	MSGTAP
•	Navigator Bone Tap, 4.1mm(D)	SGTAP4
•	Navigator Bone Tap, 4/5mm(D)	SGTAP45
•	Navigator Bone Tap, 5mm(D)	SGTAP5
•	Navigator Drill Positioning Handle 1	SGDPH1
•	Navigator Drill Positioning Handle 2	SGDPH2
•	Navigator Drill Positioning Handle 3	SGDPH3
•	Navigator Drill Positioning Handle 4	SGDPH4
•	Navigator Drill Positioning Handle 5	SGDPH5
•	Certain® Manual Bone Profiler, 3.4mm(D) x 4.1mm(P)	IMMBP
•	Certain Manual Bone Profiler, 4.1mm(D) x 5mm(P)	IMBP4
•	Certain Manual Bone Profiler, 5mm(D) x 6mm(P)	IMBP5
•	Narrow Right Angle Large Hexed Driver Tip, 24mm(L)	RASH3N
•	Open End Wrench	CW100
•	Ratchet Wrench	WR150
•	Handpiece Connector	MDR10
•	Posterior Large Hexed Driver, 17mm(L)	PHD02N
•	Ratchet Extension - Short, 6mm(L)	RE100
•	Ratchet Extension - Long, 15mm(L)	RE200
•	Navigator Certain Implant Mount, 3.4mm(D) x 1(L)	MSGIIM1
•	Navigator Certain Implant Mount, 3.4mm(D) x 2(L)	MSGIIM2
•	Navigator Certain Implant Mount, 3.4mm(D) x 3(L)	MSGIIM3
•	Navigator Certain Implant Mount, 3.4mm(D) x 4(L)	MSGIIM4
•	Navigator Certain Implant Mount, 4.1mm(D) x 1(L)	SGIIM41
•	Navigator Certain Implant Mount, 4.1mm(D) x 2(L)	SGIIM42
•	Navigator Certain Implant Mount, 4.1mm(D) x 3(L)	SGIIM43
•	Navigator Certain Implant Mount, 4.1mm(D) x 4(L)	SGIIM44
•	Navigator Certain Implant Mount, 5mm(D) x 1(L)	SGIIM51
•	Navigator Certain Implant Mount, 5mm(D) x 2(L)	SGIIM52
•	Navigator Certain Implant Mount, 5mm(D) x 3(L)	SGIIM53
•	Navigator Certain Implant Mount, 5mm(D) x 4(L)	SGIIM54

The following items are not included in the Navigator Surgical Kit, but can be ordered separately, as needed, through  Customer Service.

Description	Item Numbers	Description	Item Numbers
Navigator Twist Drill, 2mm(D) x Y(L)	SGD2Y	Navigator Twist Drill, 3.25mm(D) x Y(L)	SGD325Y
Navigator Twist Drill, 2mm(D) x Z(L)	SGD2Z	Navigator Twist Drill, 3.25mm(D) x Z(L)	SGD325Z
Navigator Twist Drill, 2.75mm(D) x Y(L)	SGD275Y	Navigator Twist Drill, 3.85mm(D) x Y(L)	SGD385Y
Navigator Twist Drill, 2.75mm(D) x Z(L)	SGD275Z	Navigator Twist Drill, 3.85mm(D) x Z(L)	SGD385Z
Navigator Twist Drill, 3mm(D) x Y(L)	SGD3Y	Navigator Twist Drill, 4.25mm(D) x Y(L)	SGD425Y
Navigator Twist Drill, 3mm(D) x Z(L)	SGD3Z	Navigator Twist Drill, 4.25mm(D) x Z(L)	SGD425Z

Some products may not be available outside of the United States.
 Algunos productos no se comercializan fuera de EE.UU.
 Certains produits ne sont pas disponibles en dehors des États-Unis.
 Einige Produkte sind außerhalb der USA nicht erhältlich.

Site Preparation Technologies

Parallel Walled
Navigator® System
For Guided Surgery

SGLKIT Navigator Parallel Walled Laboratory Kit



 SGLKIT Laboratory Kit	Description	Item Numbers
•	Navigator Laboratory Tray	SGLTRAY
•	Navigator Certain® Analog Mount, 3.4mm(D) x 1(L)	MSGIAM1
•	Navigator Certain Analog Mount, 3.4mm(D) x 2(L)	MSGIAM2
•	Navigator Certain Analog Mount, 3.4mm(D) x 3(L)	MSGIAM3
•	Navigator Certain Analog Mount, 3.4mm(D) x 4(L)	MSGIAM4
•	Navigator Certain Analog Mount, 4.1mm(D) x 1(L)	SGIAM41
•	Navigator Certain Analog Mount, 4.1mm(D) x 2(L)	SGIAM42
•	Navigator Certain Analog Mount, 4.1mm(D) x 3(L)	SGIAM43
•	Navigator Certain Analog Mount, 4.1mm(D) x 4(L)	SGIAM44
•	Navigator Certain Analog Mount, 5mm(D) x 1(L)	SGIAM51
•	Navigator Certain Analog Mount, 5mm(D) x 2(L)	SGIAM52
•	Navigator Certain Analog Mount, 5mm(D) x 3(L)	SGIAM53
•	Navigator Certain Analog Mount, 5mm(D) x 4(L)	SGIAM54

31-3100 BIOMET 2mm Fixation System

To order, call 1-800-874-7711
www.BiometMicrofixation.com



Some products may not be available outside of the United States.
Algunos productos no se comercializan fuera de EE.UU.
Certains produits ne sont pas disponibles en dehors des États-Unis.
Einige Produkte sind außerhalb der USA nicht erhältlich.

Site Preparation Technologies

Tapered Implant Surgical Kits

SLIMKT Slim Kit - Certain®





SLIMKTE Slim Kit - Certain & External Hex

(pictured)



QNTSK40 Premium Kit







 SLIMKT Certain	 SLIMKTE Certain/External Hex	 QNTSK20 Starter (Basic) Kit	 QNTSK40U Upgrade Kit	 QNTSK40 Premium Kit	Description	Item Numbers
•	•		•	•	Quad Shaping Drill, 3.25mm(D) x 8.5mm(L)	QSD3285
•	•	•	•	•	Quad Shaping Drill, 3.25mm(D) x 10mm(L)	QSD3210
•	•	•	•	•	Quad Shaping Drill, 3.25mm(D) x 11.5mm(L)	QSD3211
•	•	•	•	•	Quad Shaping Drill, 3.25mm(D) x 13mm(L)	QSD3213
			•	•	Quad Shaping Drill, 3.25mm(D) x 15mm(L)	QSD3215
•	•		•	•	Quad Shaping Drill, 4mm(D) x 8.5mm(L)	QSD485
•	•	•	•	•	Quad Shaping Drill, 4mm(D) x 10mm(L)	QSD410
•	•	•	•	•	Quad Shaping Drill, 4mm(D) x 11.5mm(L)	QSD411
•	•	•	•	•	Quad Shaping Drill, 4mm(D) x 13mm(L)	QSD413
			•	•	Quad Shaping Drill, 4mm(D) x 15mm(L)	QSD415
			•	•	Quad Shaping Drill, 5mm(D) x 8.5mm(L)	QSD585
		•	•	•	Quad Shaping Drill, 5mm(D) x 10mm(L)	QSD510
		•	•	•	Quad Shaping Drill, 5mm(D) x 11.5mm(L)	QSD511
		•	•	•	Quad Shaping Drill, 5mm(D) x 13mm(L)	QSD513
			•	•	Quad Shaping Drill, 5mm(D) x 15mm(L)	QSD515
			•	•	Quad Shaping Drill, 6mm(D) x 8.5mm(L)	QSD685
			•	•	Quad Shaping Drill, 6mm(D) x 10mm(L)	QSD610
			•	•	Quad Shaping Drill, 6mm(D) x 11.5mm(L)	QSD611
			•	•	Quad Shaping Drill, 6mm(D) x 13mm(L)	QSD613
			•	•	Quad Shaping Drill, 6mm(D) x 15mm(L)	QSD615
•	•		•	•	Dense Bone Tap, 3.25mm(D) x 8.5mm(L)	NTAP3285
•	•	•	•	•	Dense Bone Tap, 3.25mm(D) x 10mm(L)	NTAP3210
•	•	•	•	•	Dense Bone Tap, 3.25mm(D) x 11.5mm(L)	NTAP3211
•	•	•	•	•	Dense Bone Tap, 3.25mm(D) x 13mm(L)	NTAP3213
			•	•	Dense Bone Tap, 3.25mm(D) x 15mm(L)	NTAP3215
•	•		•	•	Dense Bone Tap, 4mm(D) x 8.5mm(L)	NTAP485
•	•	•	•	•	Dense Bone Tap, 4mm(D) x 10mm(L)	NTAP410
•	•	•	•	•	Dense Bone Tap, 4mm(D) x 11.5mm(L)	NTAP411
•	•	•	•	•	Dense Bone Tap, 4mm(D) x 13mm(L)	NTAP413
			•	•	Dense Bone Tap, 4mm(D) x 15mm(L)	NTAP415
			•	•	Dense Bone Tap, 5mm(D) x 8.5mm(L)	NTAP585
		•	•	•	Dense Bone Tap, 5mm(D) x 10mm(L)	NTAP510

Some products may not be available outside of the United States.
 Algunos productos no se comercializan fuera de EE.UU.
 Certains produits ne sont pas disponibles en dehors des États-Unis.
 Einige Produkte sind außerhalb der USA nicht erhältlich.

Site Preparation Technologies

Tapered Surgical Kits Cont'd





 SLIMKT Certain®	 SLIMKTE Certain/External Hex	 QNTSK20 Starter (Basic) Kit	 QNTSK40U Upgrade Kit	 QNTSK40 Premium Kit	<i>Description</i>	<i>Item Numbers</i>
		•	•	•	Dense Bone Tap, 5mm(D) x 11.5mm(L)	NTAP511
		•	•	•	Dense Bone Tap, 5mm(D) x 13mm(L)	NTAP513
			•	•	Dense Bone Tap, 5mm(D) x 15mm(L)	NTAP515
			•	•	Dense Bone Tap, 6mm(D) x 8.5mm(L)	NTAP685
			•	•	Dense Bone Tap, 6mm(D) x 10mm(L)	NTAP610
			•	•	Dense Bone Tap, 6mm(D) x 11.5mm(L)	NTAP611
			•	•	Dense Bone Tap, 6mm(D) x 13mm(L)	NTAP613
			•	•	Dense Bone Tap, 6mm(D) x 15mm(L)	NTAP615
		•	•	•	Tapered Implant Dense Bone Tap Kit Tray	NTAPKT
•	•		•	•	Tapered Implant Depth Indicator, 3.25mm(D) x 8.5mm(L) 3ea.	NTDI3285*
•	•	•	•	•	Tapered Implant Depth Indicator, 3.25mm(D) x 10mm(L)	NTDI3210
•	•	•	•	•	Tapered Implant Depth Indicator, 3.25mm(D) x 11.5mm(L)	NTDI3211
•	•	•	•	•	Tapered Implant Depth Indicator, 3.25mm(D) x 13mm(L)	NTDI3213
			•	•	Tapered Implant Depth Indicator, 3.25mm(D) x 15mm(L)	NTDI3215
•	•		•	•	Tapered Implant Depth Indicator, 4mm(D) x 8.5mm(L) 3ea.	NTDI485*
•	•	•	•	•	Tapered Implant Depth Indicator, 4mm(D) x 10mm(L)	NTDI410
•	•	•	•	•	Tapered Implant Depth Indicator, 4mm(D) x 11.5mm(L)	NTDI411
•	•	•	•	•	Tapered Implant Depth Indicator, 4mm(D) x 13mm(L)	NTDI413
			•	•	Tapered Implant Depth Indicator, 4mm(D) x 15mm(L)	NTDI415
			•	•	Tapered Implant Depth Indicator, 5mm(D) x 8.5mm(L) 3ea.	NTDI585
		•	•	•	Tapered Implant Depth Indicator, 5mm(D) x 10mm(L)	NTDI510
		•	•	•	Tapered Implant Depth Indicator, 5mm(D) x 11.5mm(L)	NTDI511
		•	•	•	Tapered Implant Depth Indicator, 5mm(D) x 13mm(L)	NTDI513
			•	•	Tapered Implant Depth Indicator, 5mm(D) x 15mm(L)	NTDI515
			•	•	Tapered Implant Depth Indicator, 6mm(D) x 8.5mm(L) 3ea.	NTDI685
			•	•	Tapered Implant Depth Indicator, 6mm(D) x 10mm(L)	NTDI610
			•	•	Tapered Implant Depth Indicator, 6mm(D) x 11.5mm(L)	NTDI611
			•	•	Tapered Implant Depth Indicator, 6mm(D) x 13mm(L)	NTDI613
			•	•	Tapered Implant Depth Indicator, 6mm(D) x 15mm(L)	NTDI615
•	•	•	•	•	Certain Countersink Drill, 4mm(D)	ICD100
		•		•	QSD/NTDI Surgical Tray w/Plastic Insert	QNTSKT
	•	•		•	Open End Wrench	CW100
		•		•	Ratchet Wrench	WR150
•	•				Hight Torque Indicating Ratchet Wrench	H-TIRW
•	•	•		•	Ratchet Extension (Short), 6mm(L)	RE100
		•		•	Ratchet Extension (Long), 15mm(L)	RE200

*One (1) each for SLIMKT and SLIMKTE.

Some products may not be available outside of the United States.
 Algunos productos no se comercializan fuera de EE.UU.
 Certains produits ne sont pas disponibles en dehors des États-Unis.
 Einige Produkte sind außerhalb der USA nicht erhältlich.

Site Preparation Technologies

Tapered Surgical Kits Cont'd

 SLIMKT Certain®	 SLIMKTE Certain/External Hex	 QNTSK20 Starter (Basic) Kit	 QNTSK40U Upgrade Kit	 QNTSK40 Premium Kit	<i>Description</i>	<i>Item Numbers</i>
		•		•	Implant Depth Gauge, 20mm(L)	DP020
	•	•		•	Narrow Posterior Hexed Driver, 17mm(L)	PHD00N
•	•	•		•	Posterior Large Hexed Driver, 17mm(L)	PHD02N
				•	Narrow Right Angle Large Hexed Driver Tip, 24mm(L)	RASH3N
				•	Direction Indicator, 2mm(D) x 10mm(L) 3ea.	DI100
•	•	•		•	Handpiece Connector	MDR10
	•	•		•	Implant Mount, 3.4mm(D) x 15mm(L)	MMC15
•	•	•		•	ACT® Pointed Starter Drill	ACTPSD
		•		•	ACT Reusable Twist Drill, 2mm(D) x 10mm(L)	ACT2010
•	•	•		•	ACT Reusable Twist Drill, 2mm(D) x 15mm(L)	ACT2015
		•		•	ACT Reusable Twist Drill, 2mm(D) x 20mm(L)	ACT2020
•	•	•		•	ACT Drill Extension	ACTDE
•	•	•		•	Certain Implant Placement Driver Tip (Short), 4.1, 5, 6mm(D)	IIPDTS
•	•	•		•	Certain Implant Placement Driver Tip (Short), 3.4mm(D)	IMPDTS
		•		•	Certain Implant Placement Driver Tip (Long), 4.1, 5, 6mm(D)	IIPDTL
		•		•	Certain Implant Placement Driver Tip (Long), 3.4mm(D)	IMPDTL
		•		•	Certain Universal Ratchet Extension Driver (Short), 6mm(L)	IRE100U
•	•	•		•	Certain Universal Ratchet Extension Driver (Long), 15mm(L)	IRE200U
		•		•	Certain Driver Replacement O-Rings, 10-pack	IRORDR

Some products may not be available outside of the United States.
 Algunos productos no se comercializan fuera de EE.UU.
 Certains produits ne sont pas disponibles en dehors des États-Unis.
 Einige Produkte sind außerhalb der USA nicht erhältlich.



Site Preparation Technologies

Parallel Walled Surgical Kits

For Certain® Internal Connection Implants

PSKT40 Premium Kit





 PSKT01 Starter (Basic) Kit	 PSKT35 Certain Premium Kit	 PSKT40 Premium Kit	Description	Item Numbers
•	•	•	Plastic Surgical Tray Organizer	PTT3001
		•	Plastic Tray Organizer for PTT3001	PTT100
	•	•	ACT® Reusable Twist Drill, 2mm(D) x 10mm(L)	ACT2010
•	•	•	ACT Reusable Twist Drill, 2mm(D) x 15mm(L)	ACT2015
	•	•	ACT Reusable Twist Drill, 2mm(D) x 20mm(L)	ACT2020
	•	•	ACT Reusable Twist Drill, 2.75mm(D) x 10mm(L)	ACT2710
•	•	•	ACT Reusable Twist Drill, 2.75mm(D) x 15mm(L)	ACT2715
		•	ACT Reusable Twist Drill, 2.75mm(D) x 20mm(L)	ACT2720
	•	•	ACT Reusable Twist Drill, 3mm(D) x 10mm(L)	ACT3010
•	•	•	ACT Reusable Twist Drill, 3mm(D) x 15mm(L)	ACT3015
		•	ACT Reusable Twist Drill, 3mm(D) x 20mm(L)	ACT3020
	•	•	ACT Reusable Twist Drill, 3.25mm(D) x 10mm(L)	ACT3210
•	•	•	ACT Reusable Twist Drill, 3.25mm(D) x 15mm(L)	ACT3215
		•	ACT Reusable Twist Drill, 3.25mm(D) x 20mm(L)	ACT3220
•	•	•	ACT Reusable Twist Drill, 3.85mm(D) x 10mm(L)	ACT3810
•	•	•	ACT Reusable Twist Drill, 3.85mm(D) x 15mm(L)	ACT3815
•	•	•	ACT Reusable Twist Drill, 3.85mm(D) x 20mm(L)	ACT3820
	•	•	ACT Reusable Twist Drill, 4.25mm(D) x 8.5mm(L)	ACT4285
•	•	•	ACT Reusable Twist Drill, 4.25mm(D) x 13mm(L)	ACT4213
	•	•	ACT Reusable Twist Drill, 4.25mm(D) x 18mm(L)	ACT4218
	•	•	ACT Reusable Twist Drill, 4.85mm(D) x 8.5mm(L)	ACT4885
	•	•	ACT Reusable Twist Drill, 4.85mm(D) x 13mm(L)	ACT4813
	•	•	ACT Reusable Twist Drill, 4.85mm(D) x 18mm(L)	ACT4818
	•	•	ACT Reusable Twist Drill, 5.25mm(D) x 8.5mm(L)	ACT5285
	•	•	ACT Reusable Twist Drill, 5.25mm(D) x 13mm(L)	ACT5213
	•	•	ACT Reusable Twist Drill, 5.25mm(D) x 18mm(L)	ACT5218
•	•	•	ACT Drill Extension	ACTDE
	•	•	Countersink Drill, OSSEOTITE XP® 4/5, PREVAIL® 4/5/4	CD4500
•	•	•	Countersink Depth Indicator for CD4500	CDI4500
•	•	•	Countersink/Pilot Drill, 5mm(D)	CD500
	•	•	Countersink Drill, OSSEOTITE XP 5/6, PREVAIL 5/6/5	CD5600

Some products may not be available outside of the United States.
 Algunos productos no se comercializan fuera de EE.UU.
 Certains produits ne sont pas disponibles en dehors des États-Unis.
 Einige Produkte sind außerhalb der USA nicht erhältlich.

Site Preparation Technologies

Parallel Walled Surgical Kits Cont'd



 PSKT01 Starter (Basic) Kit	 PSKT35 Certain® Premium Kit	 PSKT40 Premium Kit	Description	Item Numbers
•	•	•	Countersink Depth Indicator for CD5600	CDI5600
•	•	•	Certain Countersink Drill, 4mm(D)	ICD100
•	•	•	Countersink Depth Indicator for ICD100	ICDI100
•		•	Countersink Drill, 4.1mm(D)	CD100
	•	•	Countersink/Pilot Drill, 6mm(D)	CD600
•	•	•	Pilot Drill, 2-3mm(D)	PD100
	•	•	Implant Dense Bone Tap, 3.25mm(D) x 18mm(L)	MTAP2
	•	•	Implant Dense Bone Tap, 4mm(D) x 13mm(L)	TAP413
	•	•	Implant Dense Bone Tap, 5mm(D) x 13mm(L)	TAP53S
		•	Implant Dense Bone Tap, 6mm(D) x 13mm(L)	TAP63S
	•	•	OSSEOTITE® 2 Dense Bone Tap, 5mm(D) x 7-13mm(L)	XTAP53S
		•	OSSEOTITE 2 Dense Bone Tap, 6mm(D) x 7-13mm(L)	XTAP63S
	•	•	Certain Implant Driver Tip (Short), 3.4mm(D)	IMPDTS
•	•	•	Certain Implant Driver Tip (Long), 3.4mm(D)	IMPDTL
•	•	•	Certain Implant Placement Driver Tip (Short), 4.1, 5, 6mm(D)	IIPDTS
•	•	•	Certain Implant Placement Driver Tip (Long), 4.1, 5, 6mm(D)	IIPDTL
•	•	•	Certain Universal Ratchet Extension Driver (Short), 6mm(L)	IRE100U
•	•	•	Certain Universal Ratchet Extension Driver (Long), 15mm(L)	IRE200U
•		•	Narrow Small Hexed Hand Driver, 17mm(L)	PHD00N
•	•	•	Narrow Large Hexed Hand Driver, 17mm(L)	PHD02N
•	•	•	Narrow Large Hexed Driver, Tip 24mm(L)	RASH3N
	•	•	Driver Tip Replacement O-Rings, 10-pack	IRORDR
•	•	•	Handpiece Connector	MDR10
•		•	Open End Wrench	CW100
•	•	•	Ratchet Wrench	WR150
•		•	Ratchet Extension (Short), 6mm(L)	RE100
•	•	•	Ratchet Extension (Long), 15mm(L)	RE200
•	•	•	Implant Depth Gauge, 20mm(L)	DP020
•		•	Implant Mount, 3.4mm(D) x 15mm(L)	MMC15
•	•	•	Direction Indicator, 2mm(D) x 10mm(L) 3ea.	DI100
•	•	•	Stainless Steel Round Drill, 2mm(D)	RD100

Some products may not be available outside of the United States.
 Algunos productos no se comercializan fuera de EE.UU.
 Certains produits ne sont pas disponibles en dehors des États-Unis.
 Einige Produkte sind außerhalb der USA nicht erhältlich.

Site Preparation Technologies

Parallel Walled Surgical Kits



For External Hex Connection Implants

 PSKT10 Starter (Basic) Kit	 PSKT20 Standard Kit	 PSKT30 Premium Kit	Description	Item Numbers
•	•	•	Plastic Surgical Tray Organizer	PTT300I
	•	•	Plastic Organizer Tray for PTT300I	PTT100
	•	•	ACT® Reusable Twist Drill, 2mm(D) x 10mm(L)	ACT2010
	•	•	ACT Reusable Twist Drill, 2mm(D) x 15mm(L)	ACT2015
	•	•	ACT Reusable Twist Drill, 2mm(D) x 20mm(L)	ACT2020
	•	•	ACT Reusable Twist Drill, 2.75mm(D) x 10mm(L)	ACT2710
	•	•	ACT Reusable Twist Drill, 2.75mm(D) x 15mm(L)	ACT2715
	•	•	ACT Reusable Twist Drill, 2.75mm(D) x 20mm(L)	ACT2720
	•	•	ACT Reusable Twist Drill, 3mm(D) x 10mm(L)	ACT3010
	•	•	ACT Reusable Twist Drill, 3mm(D) x 15mm(L)	ACT3015
	•	•	ACT Reusable Twist Drill, 3mm(D) x 20mm(L)	ACT3020
	•	•	ACT Reusable Twist Drill, 3.25mm(D) x 10mm(L)	ACT3210
	•	•	ACT Reusable Twist Drill, 3.25mm(D) x 15mm(L)	ACT3215
	•	•	ACT Reusable Twist Drill, 3.25mm(D) x 20mm(L)	ACT3220
		•	ACT Reusable Twist Drill, 4.25mm(D) x 8.5mm(L)	ACT4285
		•	ACT Reusable Twist Drill, 4.25mm(D) x 13mm(L)	ACT4213
		•	ACT Reusable Twist Drill, 4.25mm(D) x 18mm(L)	ACT4218
		•	ACT Reusable Twist Drill, 5.25mm(D) x 8.5mm(L)	ACT5285
		•	ACT Reusable Twist Drill, 5.25mm(D) x 13mm(L)	ACT5213
		•	ACT Reusable Twist Drill, 5.25mm(D) x 18mm(L)	ACT5218
	•	•	ACT Drill Extension	ACTDE
	•	•	Pilot Drill, 2-3mm(D)	PD100
	•	•	Countersink Drill, 4.1mm(D)	CD100
		•	Countersink Drill, OSSEOTITE XP® 4/5, PREVAIL® 4/5/4	CD4500
		•	Countersink/Pilot Drill, 5mm(D)	CD500
		•	Countersink Drill, OSSEOTITE XP 5/6, PREVAIL 5/6/5	CD5600
		•	Countersink/Pilot Drill, 6mm(D)	CD600
	•	•	Implant Dense Bone Tap, 3.25mm(D) x 18mm(L)	MTAP2
	•	•	Implant Dense Bone Tap, 4mm(D) x 13mm(L)	TAP413
		•	Implant Dense Bone Tap, 5mm(D) x 13mm(L)	TAP53S
		•	Implant Dense Bone Tap, 6mm(D) x 13mm(L)	TAP63S
		•	OSSEOTITE® 2 Dense Bone Tap, 5mm(D) x 7-13mm(L)	XTAP53S
		•	OSSEOTITE 2 Dense Bone Tap, 6mm(D) x 7-13mm(L)	XTAP63S

Some products may not be available outside of the United States.
 Algunos productos no se comercializan fuera de EE.UU.
 Certains produits ne sont pas disponibles en dehors des États-Unis.
 Einige Produkte sind außerhalb der USA nicht erhältlich.

Site Preparation Technologies

Parallel Walled Surgical Kits Cont'd

 PSKT10 Starter (Basic) Kit	 PSKT20 Standard Kit	 PSKT30 Premium Kit	Description	Item Numbers
•	•	•	Narrow Small Hexed Hand Driver, 17mm(L)	PHD00N
•	•	•	Narrow Large Hexed Hand Driver, 17mm(L)	PHD02N
•	•	•	Narrow Large Hexed Driver Tip, 24mm(L)	RASH3N
•	•	•	Handpiece Connector	MDR10
•	•	•	Open End Wrench	CW100
•	•	•	Ratchet Wrench	WR150
•	•	•	Ratchet Extension (Short), 6mm(L)	RE100
•	•	•	Ratchet Extension (Long), 15mm(L)	RE200
•	•	•	Implant Depth Gauge, 20mm(L)	DP020
	•	•	Implant Mount, 3.4mm(D) x 15mm(L)	MMC15
	•	•	Direction Indicator, 2mm(D) x 10mm(L) 3ea.	DI100
	•	•	Stainless Steel Round Drill, 2mm(D)	RD100

PTT100 Plastic Tray Organizer

NOTE: For use with PTT300I



Some products may not be available outside of the United States.
 Algunos productos no se comercializan fuera de EE.UU.
 Certains produits ne sont pas disponibles en dehors des États-Unis.
 Einige Produkte sind außerhalb der USA nicht erhältlich.

Site Preparation Technologies

ACT® Non-Irrigated Reusable Twist Drills

Implant Lengths	Drill Lengths	2mm(D)	2.3mm(D)	2.75mm(D)	3mm(D)	3.15mm(D)	3.25mm(D)	3.85mm(D)	4.25mm(D)	4.85mm(D)	5.25mm(D)
7 – 8.5mm	8.5mm	N/A	N/A	N/A	N/A	N/A	N/A	N/A	ACT4285	ACT4885	ACT5285
7 – 10mm	10mm	ACT2010	N/A	ACT2710	ACT3010	ACT3110	ACT3210	ACT3810	N/A	N/A	N/A
7 – 13mm	13mm	N/A	N/A	N/A	N/A	N/A	N/A	N/A	ACT4213	ACT4813	ACT5213
7 – 15mm	15mm	ACT2015	N/A	ACT2715	ACT3015	ACT3115	ACT3215	ACT3815	N/A	N/A	N/A
7 – 18mm	18mm	N/A	N/A	N/A	N/A	N/A	N/A	N/A	ACT4218	ACT4818	ACT5218
7 – 20mm	20mm	ACT2020	N/A	ACT2720	ACT3020	ACT3120	ACT3220	ACT3820	N/A	N/A	N/A



Surgical Drills

Drills

Description	Disposable	Reusable
Round Drill, 2mm	DR100	RD100
ACT Pointed Starter Drill	N/A	ACTPSD
Pilot Drill, 2-3mm	DP100	PD100
Countersink Drill - External Connection, 4.1mm	DC100	CD100
Countersink Drill - Certain® Connection, 4.1mm	N/A	ICD100
Countersink Drill, 4/5mm	N/A	CD4500
Countersink/Pilot Drill, 5mm	DC500	CD500
Countersink Drill, 5/6mm	N/A	CD5600
Countersink/Pilot Drill, 6mm	DC600	CD600

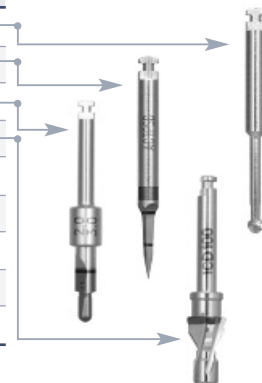

Quad Shaping Drills For Tapered Implants

Drill Lengths	3.25mm(D)	4mm(D)	5mm(D)	6mm(D)
8.5mm	QSD3285	QSD485	QSD585	QSD685
10mm	QSD3210	QSD410	QSD510	QSD610
11.5mm	QSD3211	QSD411	QSD511	QSD611
13mm	QSD3213	QSD413	QSD513	QSD613
15mm	QSD3215	QSD415	QSD515	QSD615

Some products may not be available outside of the United States.
 Algunos productos no se comercializan fuera de EE.UU.
 Certains produits ne sont pas disponibles en dehors des États-Unis.
 Einige Produkte sind außerhalb der USA nicht erhältlich.

Site Preparation Technologies

Surgical Components

Handpiece Bone Profilers

Description	Item Numbers
Bone Profiler, 3.4mm(D) x 3.8mm(P)	BP340
Bone Profiler, 3/4, 4.1mm(D) x 5mm(P)	BP450
Bone Profiler, 3/4, 4.1mm(D) x 6mm(P)	BP460
Bone Profiler, 3/4, 4.1mm(D) x 7.5mm(P)	BP475
Bone Profiler, 4/5, 5mm(D) x 5mm(P)	BP550
Bone Profiler, 4/5, 5mm(D) x 6mm(P)	BP560
Bone Profiler, 4/5, 5mm(D) x 7.5mm(P)	BP575
Bone Profiler, 5/6, 6mm(D) x 6mm(P)	BP660
Bone Profiler, 5/6, 6mm(D) x 7.5mm(P)	BP675



Low Profile Abutment Bone Profilers

Low Profile Abutment Bone Profiler, 3.4mm(D)	LPCBP3
Low Profile Abutment Bone Profiler, 4.1mm(D)	LPCBP4
Low Profile Abutment Bone Profiler, 5mm(D)	LPCBP5



Certain® Manual Bone Profilers

Certain Manual Bone Profiler, 3.4mm(D) x 4.1mm(P)	IMMBP
Certain Manual Bone Profiler, 3.4mm(D) x 5mm(P)	IMMBP35
Certain Manual Bone Profiler, 4.1mm(D) x 5mm(P)	IMBP4
Certain Manual Bone Profiler, 5mm(D) x 6mm(P)	IMBP5
Certain Low Profile Abutment Manual Bone Profiler, 3.4mm(D)	ILPCMBP3
Certain Low Profile Abutment Manual Bone Profiler, 4.1mm(D)	ILPCMBP4
Certain Low Profile Abutment Manual Bone Profiler, 5mm(D)	ILPCMBP5



Bone Profiler Guide Pins

Bone Profiler Guide Pin, 3.4, 4.1, 5 & 6mm(D)	BPGUIDE
---	---------

Guide Pins are included in all External Connection Bone Profiler Components and Kits. For Certain Internal Connections, please order the appropriate Certain Bone Profiler Guide Pin listed below.

Certain Bone Profiler Guide Pin, 3.25mm(D) 3-pack	IBPMGP
Certain Bone Profiler Guide Pin, 4.1, 5 & 6mm(D) 3-pack	IBPGP



Bone Profiler Organizers & Kits

Bone Profiler Organizer Box, 4.1mm(D)	BPKITB
Bone Profiler Organizer Box, 5 & 6mm(D)	BPAKTB
Bone Profiler Organizer Kit	BB001
Bone Profiler Kit - For use with 4.1mm(D) Implants Contains: BP450, BP460, BP475, BB001	BPKIT
Bone Profiler Kit - For use with 5mm(D) or 6mm(D) Implants Contains: BP550, BP560, BP575, BP660, BP675, BB001	BPAKT



Some products may not be available outside of the United States.
Algunos productos no se comercializan fuera de EE.UU.
Certains produits ne sont pas disponibles en dehors des États-Unis.
Einige Produkte sind außerhalb der USA nicht erhältlich.

Site Preparation Technologies

Surgical Components

Bone Taps



Implant Lengths	3.25mm(D)	3.75mm(D)	4mm(D)	5mm(D)	6mm(D)
8.5 – 18mm	MTAP1 (18mmL)	N/A	N/A	N/A	N/A
8.5 – 18mm	MTAP2 (27mmL)	N/A	N/A	N/A	N/A
7 – 10mm	N/A	TAP10	TAP410	N/A	N/A
7 – 13mm	N/A	TAP13	TAP413	N/A	N/A
7 – 20mm	N/A	TAP20	TAP420	N/A	N/A
7 – 8.5mm	N/A	N/A	N/A	TAP58S	TAP68S
7 – 13mm	N/A	N/A	N/A	TAP53S	TAP63S
7 – 18mm	N/A	N/A	N/A	TAP518S	TAP618S

Bone Taps - OSSEOTITE® & 3iT3 IMPLANT™

6.5/7 – 8.5mm	N/A	N/A	N/A	XTAP58S	XTAP68S
6.5/7 – 13mm	N/A	N/A	N/A	XTAP53S	XTAP63S
6.5/7 – 18mm	N/A	N/A	N/A	XTAP518S	XTAP618S

Dense Bone Taps For Tapered Implants



Implant Lengths	3.25mm(D)	4mm(D)	5mm(D)	6mm(D)
8.5mm	NTAP3285	NTAP485	NTAP585	NTAP685
10mm	NTAP3210	NTAP410	NTAP510	NTAP610
11.5mm	NTAP3211	NTAP411	NTAP511	NTAP611
13mm	NTAP3213	NTAP413	NTAP513	NTAP613
15mm	NTAP3215	NTAP415	NTAP515	NTAP615

NTAPK Dense Bone Tap Kit

NOTE: Kit includes all of the Dense Bone Taps listed above.



Some products may not be available outside of the United States.
 Algunos productos no se comercializan fuera de EE.UU.
 Certains produits ne sont pas disponibles en dehors des États-Unis.
 Einige Produkte sind außerhalb der USA nicht erhältlich.

Site Preparation Technologies

Surgical Components

Depth/Direction Indicators For Tapered Implants



Implant Lengths	3.25mm(D)	4mm(D)	5mm(D)	6mm(D)
8.5mm	NTDI3285	NTDI485	NTDI585	NTDI685
10mm	NTDI3210	NTDI410	NTDI510	NTDI610
11.5mm	NTDI3211	NTDI411	NTDI511	NTDI611
13mm	NTDI3213	NTDI413	NTDI513	NTDI613
15mm	NTDI3215	NTDI415	NTDI515	NTDI615

NTDIK Depth/Direction Indicator Kit

NOTE: Kit includes all of the indicators listed above.

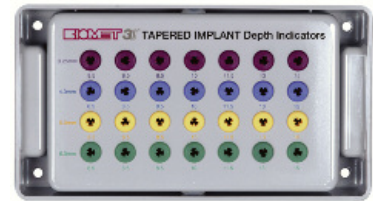

Direction Indicators

DI100 2mm/3mm(D) x 10mm(L)
DI200 2mm/3mm(D) x 15mm(L)

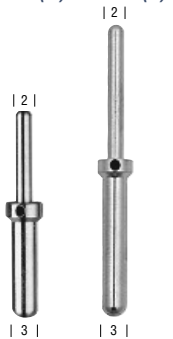

DI2310 2.3mm/3mm(D) x 10mm(L)
 Anodized Blue



DI2315 2.3mm/3mm(D) x 15mm(L)
 Anodized Gold



Mounts

IDIKT **Certain® Direction Indicator Kit**
ID1001 10mm(L)
ID1001 10mm(L)
 For 3.25mm(D) Implant



IC015 **15mm(L) Implant Mount**

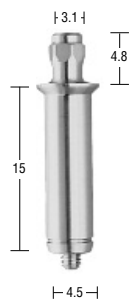

MMKIT **3.4mm(D) Implant Mount Kit**
 Includes 2 each of:
MMC03 3mm(L)
MMC15 15mm(L)

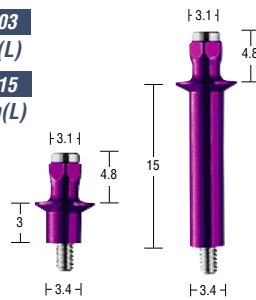

Some products may not be available outside of the United States.
 Algunos productos no se comercializan fuera de EE.UU.
 Certains produits ne sont pas disponibles en dehors des États-Unis.
 Einige Produkte sind außerhalb der USA nicht erhältlich.

Site Preparation Technologies

Surgical Components

Miscellaneous Instrumentation

H-TIRW *High Torque Indicating Ratchet Wrench*



CW100 *Open End Wrench*
For use with External Connection Implants.



TST01 *Titanium Suction Tip*



TF002 *Titanium Forceps*



MALL1 *Mallet*
Stainless Steel



TE003 *Titanium Elevator*







DP020 *Implant Depth Gauge*



MIDTH *Manual Interchangeable Driver Tip Handle*



Ratchet Extensions

		6mm(L)
IRE100U	RE100	
		15mm(L)
IRE200U	RE200	



TMP80 *Tissue Measuring Post*

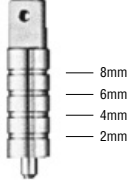

- 8mm
- 6mm
- 4mm
- 2mm

Some products may not be available outside of the United States.
Algunos productos no se comercializan fuera de EE.UU.
Certains produits ne sont pas disponibles en dehors des États-Unis.
Einige Produkte sind außerhalb der USA nicht erhältlich.

Site Preparation Technologies

Surgical Components

Miscellaneous Instrumentation

ACTDE ACT® Drill Extension



MDR10 Handpiece Connector



IC100 Surgical Index Coping



SGT25 Stent Guide Tubes
2.39 x
10mm(L)
Stainless Steel (25-PK)



IRORDR Certain® Implant Driver Replacement O-Rings
(Qty: 10)



TP001 Tissue Punch
4.1mm

TP005
5mm

TP006
6mm



IIPDTL Certain Implant Placement Driver Tip
Long

IIPDTS
Short

IMPDTL
3.4mm(D)
Long

IMPDTS
3.4mm(D)
Short



XDG00 Gelb Radiographic Depth Gauge Kit

Includes:

- XDG13**
2mm(D)x13mm(L)
- XDG20**
2mm(D)x20mm(L)
- XDG01**
2.3mm(D)

Includes:

- XDG2313**
2.3mm(D)x13mm(L)
- XDG2320**
2.3mm(D)x20mm(L)



RMB30 Radiographic Marking Balls (30-PK)
5mm(D)



Some products may not be available outside of the United States.
Algunos productos no se comercializan fuera de EE.UU.
Certains produits ne sont pas disponibles en dehors des États-Unis.
Einige Produkte sind außerhalb der USA nicht erhältlich.

Site Preparation Technologies

Site Preparation Components

Straight And Angled Osteotomes

<i>Description</i>		<i>Item Numbers</i>
Straight OSSEOTITE® Tapered	Osteotome Kit	NTOST0
Angled OSSEOTITE Tapered	Osteotome Kit	NTOST0A
Straight OSSEOTITE Tapered, 3.25mm(D)	Osteotome	NTOST3
Straight OSSEOTITE Tapered, 4mm(D)	Osteotome	NTOST4
Straight OSSEOTITE Tapered, 5mm(D)	Osteotome	NTOST5
Straight OSSEOTITE Tapered, 6mm(D)	Osteotome	NTOST6
Angled OSSEOTITE Tapered, 3.25mm(D)	Osteotome	NTOST3A
Angled OSSEOTITE Tapered, 4mm(D)	Osteotome	NTOST4A
Angled OSSEOTITE Tapered, 5mm(D)	Osteotome	NTOST5A
Angled OSSEOTITE Tapered, 6mm(D)	Osteotome	NTOST6A
Straight OSSEOTITE Tapered Osteotome Tray		NTOSTTRS
Angled OSSEOTITE Tapered Osteotome Tray		NTOSTTRA



Summer Osteotomes

<i>Description</i>		<i>Item Numbers</i>
Summers Osteotome	Kit #1-4	OST00
Summers Osteotome	Kit #1-5	OST10
Summers Osteotome	Kit #1-5, FS	OST20
Summers Osteotome	#1	OST01
Summers Osteotome	#2	OST02
Summers Osteotome	#3	OST03
Summers Osteotome	#4	OST04
Summers Osteotome	#5	OST05
Summers Osteotome For Future Site		OSTFS
Summers Osteotome System Tray		OSTTR



Some products may not be available outside of the United States.
 Algunos productos no se comercializan fuera de EE.UU.
 Certains produits ne sont pas disponibles en dehors des États-Unis.
 Einige Produkte sind außerhalb der USA nicht erhältlich.

Site Preparation Technologies

Site Preparation Components

Sinus Elevation

Description	Item Numbers
Sinus Elevation Kit	SEKT1
Titanium Nitride Coated Bone Carrier	TIBC1
Small Membrane Elevator	ME100
Medium Membrane Elevator	ME200
Large Membrane Elevator	ME300
Large Titanium Plugger	TIPL1
Small Titanium Plugger	TIPS1
Sinus Elevation Tray	SEKTR



Trephine Burs

Description	Item Numbers
Trephine Bur, 2mm Inside Diameter/3mm Outside Diameter	TRE02
Trephine Bur, 4mm Inside Diameter/5mm Outside Diameter	TRE04
Trephine Bur, 5mm Inside Diameter/6mm Outside Diameter	TRE05
Trephine Bur, 6mm Inside Diameter/7mm Outside Diameter	TRE06
Trephine Bur, 8mm Inside Diameter/9.3mm Outside Diameter	TRE08

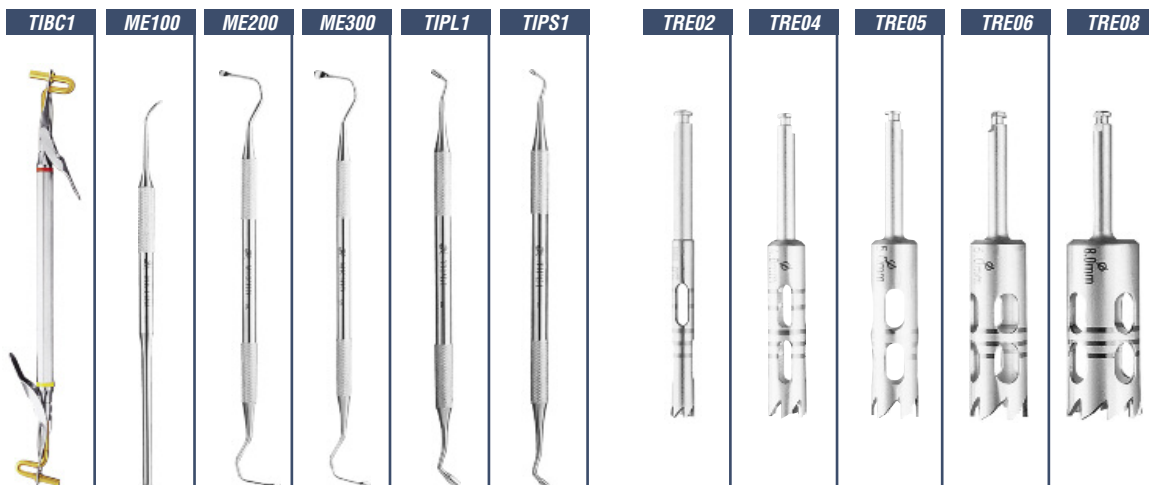

Sinus Elevators

Trephine Burs

Some products may not be available outside of the United States.
 Algunos productos no se comercializan fuera de EE.UU.
 Certains produits ne sont pas disponibles en dehors des États-Unis.
 Einige Produkte sind außerhalb der USA nicht erhältlich.

Regenerative Technologies

Product Overview



RegenerOss[®] Allograft

The options you want. The results you expect.

- Cortical or cancellous bone: mineralized or demineralized
- Three particle ranges: 200–300, 300–500, 500–800 microns
- Consistency from lot-to-lot
- Packaging is designed for ease of handling and quick, convenient reconstitution
- Aseptically processed and irradiated products available
- 5-year shelf-life

Manufactured By The University of Miami Tissue Bank



RegenerOss Allograft Putty Plus

Demineralized bone matrix and mineralized bone chips/mixture.

- Contains 48% by weight DBM (28% cortical and 20% cancellous chips) for optimal handling and bone regeneration
- Moldable, non-toxic, lecithin carrier that is highly resistant to irrigation
- Osteoinductivity of every lot is validated by a cell proliferation assay
- Ergonomic design features a smaller diameter syringe with a curved tip to treat hard-to-reach defects
- DBM only option also available
- 2-year shelf-life

Manufactured By LifeLink Tissue Bank (AATB Certified)



Endobon[®] Xenograft Granules

A RegenerOss[®] Product.

- Bovine-derived Hydroxyapatite
- Osteoconductive material for bony in-growth
- 500–1000 μ m and 1000–2000 μ m particle sizes for dental applications
- High porosity with interconnecting macro and micropores
- Easy to use packaging
- 3-year shelf-life

Manufactured By Biomet France Sarl



OsseoGuard[®] Resorbable Collagen Membrane

The protection you need to grow.

- Dental barrier for guided bone regeneration
- Type I collagen bovine tendon
- Strong enough to resist tearing when tacked or sutured, yet pliable for easy placement
- Resorption profile of 6-9 months
- Does not require removal when exposed
- 3-year shelf-life

Manufactured By Collagen Matrix, Inc., Franklin Lakes, NJ

Regenerative Technologies

Product Overview

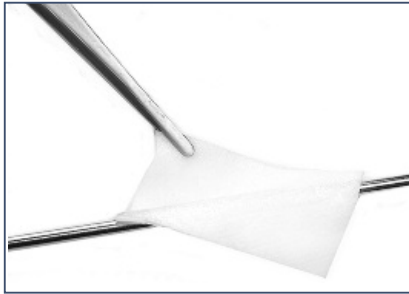

OsseoGuard Flex[®] Resorbable Collagen Membrane

Creating balance between flexibility and resorption profile.

- Same clinical benefits as OsseoGuard
- Flexible, yet won't fold over onto itself
- Type I and III bovine dermis
- 2-year shelf-life

Manufactured By Collagen Matrix, Inc., Franklin Lakes, NJ



Biogran[®] Bioactive Glass

Bioactive glass for effective regeneration in most oral applications.

- Granules are the optimal size range, large enough not to pack too densely, small enough to fully resorb
- Provides a unique protective environment needed for osteogenesis
- Completely resorbable through the Krebs cycle
- 100% synthetic
- Forms a cohesive mass when mixed with blood or sterile saline, minimizing the potential for dry socket
- Pre-formed dappen dish or pre-formed dappen dish with empty syringe
- 5-year shelf-life

Manufactured By BIOMET 3i

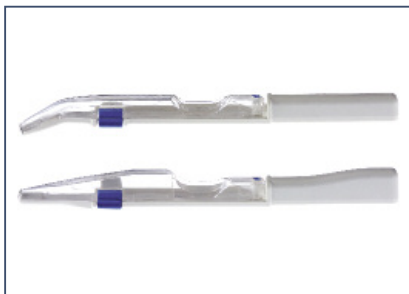

Safescraper[®] TWIST



Cortical bone scraper/collector.

- Unique design provides 160° cutting area and facilitates access to difficult posterior regions
- Effectively harvests up to 5cc of bone
- Contains bone in a sterile exclusive chamber, which is designed to protect patients from cross-contamination
- Shortens operating time and simplifies graft collection
- Lateral opening system provides device stability
- 3-year shelf-life

Manufactured By META[®] Advanced Medical Technology

Regenerative Technologies

Allografts

Description				Item Numbers
RegenerOss® Allograft Demineralized Freeze Dried Bone Allograft (DFDBA) & Freeze Dried Bone Allograft (FDBA)				
Manufactured By: 				
Cancellous, Partially Demineralized	0.5cc	200-300µm	RDCA205	
Cancellous, Partially Demineralized	1cc	200-300µm	RDCA210	
Cancellous, Partially Demineralized	0.5cc	300-500µm	RDCA305	
Cancellous, Partially Demineralized	1cc	300-500µm	RDCA310	
Cancellous, Partially Demineralized	0.5cc	500-800µm	RDCA505	
Cancellous, Partially Demineralized	1cc	500-800µm	RDCA510	
Cortical, Partially Demineralized	0.5cc	200-300µm	RDC0205	
Cortical, Partially Demineralized	1cc	200-300µm	RDC0210	
Cortical, Partially Demineralized	0.5cc	300-500µm	RDC0305	
Cortical, Partially Demineralized	1cc	300-500µm	RDC0310	
Cortical, Partially Demineralized	0.5cc	500-800µm	RDC0505	
Cortical, Partially Demineralized	1cc	500-800µm	RDC0510	
Cancellous, Mineralized	0.5cc	200-300µm	RMCA205	
Cancellous, Mineralized	1cc	200-300µm	RMCA210	
Cancellous, Mineralized	0.5cc	300-500µm	RMCA305	
Cancellous, Mineralized	1cc	300-500µm	RMCA310	
Cancellous, Mineralized	0.5cc	500-800µm	RMCA505	
Cancellous, Mineralized	1cc	500-800µm	RMCA510	
Cortical, Mineralized	0.5cc	200-300µm	RMCO205	
Cortical, Mineralized	1cc	200-300µm	RMCO210	
Cortical, Mineralized	0.5cc	300-500µm	RMCO305	
Cortical, Mineralized	1cc	300-500µm	RMCO310	
Cortical, Mineralized	0.5cc	500-800µm	RMCO505	
Cortical, Mineralized	1cc	500-800µm	RMCO510	
Cancellous, Mineralized	2cc	200-300µm	RMCA220	
Cancellous, Mineralized	2cc	300-500µm	RMCA320	
Cancellous, Mineralized	2cc	500-800µm	RMCA520	
Cortical, Mineralized	2cc	200-300µm	RMCO220	
Cortical, Mineralized	2cc	300-500µm	RMCO320	
Cortical, Mineralized	2cc	500-800µm	RMCO520	
Cancellous, Partially Demineralized	2cc	200-300µm	RDCA220	
Cancellous, Partially Demineralized	2cc	300-500µm	RDCA320	
Cancellous, Partially Demineralized	2cc	500-800µm	RDCA520	
Cortical, Partially Demineralized	2cc	200-300µm	RDC0220	
Cortical, Partially Demineralized	2cc	300-500µm	RDC0320	
Cortical, Partially Demineralized	2cc	500-800µm	RDC0520	

Some products may not be available outside of the United States.
 Algunos productos no se comercializan fuera de EE.UU.
 Certains produits ne sont pas disponibles en dehors des États-Unis.
 Einige Produkte sind außerhalb der USA nicht erhältlich.

Regenerative Technologies

Allografts (Cont'd)

Description			Item Numbers
Cancellous, Partially Demineralized, Irradiated	0.5cc	300-500µm	RDCA305r
Cancellous, Partially Demineralized, Irradiated	1cc	300-500µm	RDCA310r
Cortical, Partially Demineralized, Irradiated	0.5cc	200-300µm	RDCO205r
Cortical, Partially Demineralized, Irradiated	0.5cc	300-500µm	RDCO305r
Cortical, Partially Demineralized, Irradiated	1cc	300-500µm	RDCO310r
Cancellous, Mineralized, Irradiated	0.5cc	200-300µm	RMCA205r
Cancellous, Mineralized, Irradiated	0.5cc	300-500µm	RMCA305r
Cortical, Mineralized, Irradiated	0.5cc	300-500µm	RMCO305r
Cancellous, Partially Demineralized, Irradiated	2cc	300-500µm	RDCA320r
Cortical, Partially Demineralized, Irradiated	2cc	300-500µm	RDCO320r
Cancellous, Mineralized, Irradiated	1cc	300-500µm	RMCA310r
Cortical, Mineralized, Irradiated	1cc	300-500µm	RMCO310r
Special Order Allograft Items: *Special order, allow up to 6 weeks.			
Dura Mater Patch (Membrane)	4x5cm		0655*
Fascia Lata Patch (Membrane)	4x5cm		0716*
Right Hemi Mandible			0630*
Left Hemi Mandible			0631*
Full Mandible			0632*
Iliac Crest Strip	Small		0055*
Iliac Crest Strip	Medium		0473*
Iliac Crest Strip	Large		0056*
Mineralized Cancellous Powder	10cc	100-200µm	1454*
Demineralized Cancellous Powder	10cc	100-200µm	1462*
Demineralized Cortical Powder	10cc	100-200µm	1465*
Dental M&M Block	Small		1507*
Dental M&M Block, Irradiated	Small		1523*
Dental M&M Block	Medium		1491*
Dental M&M Block, Irradiated	Medium		1522*
Dental M&M Block	Large		1508*
Dental M&M Block, Irradiated	Large		1565*
RegenerOss® Allograft Putty Demineralized Bone Matrix In A Lecithin Carrier <i>Manufactured By BIOMET Interpore Cross</i>			
0.5cc Syringe			ROAP05
1cc Syringe			ROAP10
2cc Syringe			ROAP20
RegenerOss Allograft Putty Plus			
0.5cc Syringe			ROAPM05
1cc Syringe			ROAPM10
2cc Pack (4 x 0.5cc syringes)	Value Pack!		ROAPM20



Some products may not be available outside of the United States.
 Algunos productos no se comercializan fuera de EE.UU.
 Certains produits ne sont pas disponibles en dehors des États-Unis.
 Einige Produkte sind außerhalb der USA nicht erhältlich.

Regenerative Technologies

Xenografts

Description		Item Numbers
Endobon® Xenograft Granules A RegenerOss® Product (Bovine-derived Hydroxyapatite Particulate) <i>Manufactured By Biomet France Sarl</i>		
500 – 1000µm	0.5ml	ROX05
500 – 1000µm	1ml	ROX10
500 – 1000µm	2ml	ROX20
1000 – 2000µm	2ml	ROXLG20
1000 – 2000µm	5ml	ROXLG50
1000 – 2000µm	8ml	ROXLG80



GBR Barriers

OsseoGuard® Membrane Cross-linked Bovine Collagen <i>Manufactured By Collagen Matrix, Inc., Franklin Lakes, NJ</i>		
Resorbable Collagen Membrane	15mm x 20mm	OG1520
Resorbable Collagen Membrane	20mm x 30mm	OG2030
Resorbable Collagen Membrane	30mm x 40mm	OG3040



OsseoGuard Flex® Membrane Cross-linked Highly Purified Bovine Dermis Collagen <i>Manufactured By Collagen Matrix, Inc., Franklin Lakes, NJ</i>		
Resorbable Collagen Membrane	15mm x 20mm	OGF1520
Resorbable Collagen Membrane	20mm x 30mm	OGF2030
Resorbable Collagen Membrane	30mm x 40mm	OGF3040

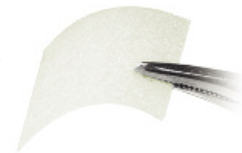

Alloplasts

Biogran® 100% Synthetic Resorbable Bone Graft Material		
Mixing Cup (750mg) & Syringe	1-Pack	2100-0750
Mixing Cups (500mg)	7-Pack	2100-0003
Mixing Cups (750mg)	7-Pack	2100-0004
Mixing Cups (1500mg)	7-Pack	2100-0005



Autogenous

Safescraper® TWIST Disposable Cortical Bone Collector (3-pack) <i>Manufactured By META® Advanced Medical Technology</i>		
	Curved	3987
	Straight	3598



R. Quéting Bone-Mill Stainless Steel Bone Grinder		QBM001
---	--	--------



Some products may not be available outside of the United States.
Algunos productos no se comercializan fuera de EE.UU.
Certains produits ne sont pas disponibles en dehors des États-Unis.
Einige Produkte sind außerhalb der USA nicht erhältlich.

Patient Education Products

Description	Item Numbers
Patient Ed Model - DIEM®2 (4-unit)	DIEM2-4UNIT
Patient Ed Model - DIEM 2 (6-unit)	DIEM2-6UNIT
Patient Ed Model - OSSEOTITE® Implant	EXHEXMOD
Patient Ed Model - LOCATOR®	PEMODLOC
Patient Ed Model - Single/Multiple Teeth	PEMODSM
Patient Ed Brochure - Bone Loss (25-pack)	ART885
Patient Ed Brochure - Multiple Teeth (25-pack)	ART887
Patient Ed Brochure - Implant Retained, Fixed (25-pack)	ART888
Patient Ed Brochure - Implant Retained, LOCATOR (25-pack)	ART889
Patient Ed Brochure - Implant Retained, Bar (25-pack)	ART890
Patient Ed Brochure - Immediate Teeth Replacement, DIEM (25-pack)	ART929
Patient Ed Care Card (25-pack)	ART930
Patient Ed Flip Chart	ART943
Patient Ed DVD - Multilingual Version	ART951EUR
Patient Ed Brochure - Bone Loss (Spanish Version)	ART957S
Patient Ed Awareness and Education Poster	ART962
Patient Ed Quad-fold Brochure with Holder (25-pack)	ART1154
Patient Ed General Brochure (25-pack)	ART1157
Patient Ed Regenerative Brochure	ART1178



Some products may not be available outside of the United States.
 Algunos productos no se comercializan fuera de EE.UU.
 Certains produits ne sont pas disponibles en dehors des États-Unis.
 Einige Produkte sind außerhalb der USA nicht erhältlich.

Important Product Information For **BIOMET 3i** Dental Implants

Instructions For Use:

For a detailed explanation of the osteotomy preparation and implant placement guidelines, please refer to the appropriate Surgical Manual(s).

Description:

BIOMET **3i** Dental Implants are manufactured from biocompatible titanium or titanium alloy. BIOMET **3i** Dental Implants include various surface treatments. For specific product descriptions, please refer to individual product labels.

Indications For Use:

BIOMET **3i** Dental Implants are intended for surgical placement in the upper or lower jaw to provide a means for prosthetic attachment in single tooth restorations and in partially or fully edentulous spans with multiple single teeth utilizing delayed loading, or as a terminal or intermediary abutment for fixed or removable bridgework, and to retain overdentures. BIOMET **3i** T3®, NanoTite™ and OSSEOTITE® Dental Implants may also utilize immediate loading for these indications.

BIOMET **3i** T3, NanoTite and OSSEOTITE Dental Implants are intended for immediate function on single tooth and/or multiple tooth applications when good primary stability is achieved, with appropriate occlusal loading, in order to restore chewing function.

Contraindications:

Placement of dental implants may be precluded by both patient conditions that are contraindications for surgery as well as hypersensitivity to commercially pure titanium or titanium alloy (including vanadium, aluminum and calcium phosphate).

BIOMET **3i** Dental Implants should not be placed in patients where the remaining jaw bone is too diminished to provide adequate implant stability.

Warnings:

Excessive bone loss or breakage of a dental implant may occur when an implant is loaded beyond its functional capability. Physiological and anatomical conditions may affect the performance of dental implants.

Mishandling of small components inside the patient's mouth carries a risk of aspiration and/or swallowing.

Forcing the implant into the osteotomy deeper than the depth established by the drills can result in damage to the implant, driver or osteotomy.

For short implants, clinicians should closely monitor patients for any of the following conditions: peri-implant bone loss, changes to the implant's response to percussion or radiographic changes in bone to implant contact along the implant's length. If the implant shows mobility or greater than 50% bone loss, the implant should be evaluated for possible removal. If a clinician chooses a short implant, then the clinician should consider a two-stage surgical approach, splinting a short implant to an additional implant and placement of the widest possible fixture. In addition, the clinician should allow longer periods for osseointegration and avoid immediate loading.

Reuse of BIOMET **3i** Products that are labeled for single-use may result in product contamination, patient infection and/or failure of the device to perform as intended.

MRI Statement:

BIOMET **3i** Dental Implants have not been evaluated for safety, heating, migration, or compatibility in the Magnetic Resonance Imaging (MRI) environment.

Precautions:

These devices are only to be used by trained professionals. The surgical and restorative techniques required to properly utilize these devices are highly specialized and complex procedures. Improper technique can lead to implant failure, loss of supporting bone, restoration fracture, screw loosening and aspiration. When the clinician has determined adequate primary stability is achieved, immediate functional loading can be considered.

The following should be taken into consideration when placing dental implants: bone quality, oral hygiene and medical conditions such as blood disorders or uncontrolled hormonal conditions. The healing period varies depending on the quality of the bone at the implantation site, the tissue response to the implanted device and the surgeon's evaluation of the patient's bone density at the time of the surgical procedure. Proper occlusion should be evaluated on the implant restoration to avoid excessive force during the healing period on the implant.

It is recommended that implants less than 4mm diameter **NOT** be placed in the posterior regions.

Sterility:

All dental implants are supplied sterile and are labeled "STERILE". All products sold sterile are for single-use before the expiration date printed on the product label. Do not use sterile products if the packaging has been damaged or previously opened. Do not re-sterilize.

Storage And Handling:

Devices should be stored at room temperature. Refer to individual product labels and the Surgical Manual for special storage or handling conditions.

Potential Adverse Events:

Potential adverse events associated with the use of dental implants may include: failure to integrate, loss of integration, dehiscence requiring bone grafting, perforation of the maxillary sinus, inferior border, lingual plate, labial plate, inferior alveolar canal or gingiva, infection as reported by abscess, fistula, suppuration, inflammation, or radiolucency, persistent pain, numbness, paresthesia, hyperplasia, excessive bone loss requiring intervention, implant breakage or fracture, systemic infection, nerve injury and aspiration.

Caution:

U.S. Federal Law restricts this device to sale by or on the order of a licensed dentist or physician.

Important Product Information For Restorative Products

Instructions For Use:

For detailed information on the specific procedure for the product you are using, please refer to the individual product labels or the appropriate manual on the BIOMET **3i** Website.

Description:

BIOMET **3i** Restorative Products are manufactured from biocompatible titanium, titanium alloy, gold, gold alloy, zirconium, vanadium, stainless steel, polyetheretherketone (PEEK), cobalt chromium alloy, and polyoxymethylene (Delrin). Please refer to product guidelines for Use/Surgical Manual for additional device information.

Indications For Use:

BIOMET **3i** Restorative Products are intended for use as an accessory to endosseous dental implants for placement in the maxilla and mandible.

Provisional Abutments are intended for use as an accessory to endosseous dental implants to support a prosthetic device in a partially or fully edentulous patient. They are intended for use to support a prosthesis in the mandible or maxilla for up to 180 days during endosseous and gingival healing, and are for non-occlusal loading of provisional restorations. The prosthesis will be either cement, mechanically or screw-retained to the abutment system based on individual product design. For compatibility of BellaTek® Patient Specific Abutments, please refer to the compatibility table in the accompanying document.

Contraindications:

Placement of BIOMET **3i** Restorative Products are precluded by known patient hypersensitivity to any of the materials listed in the Description section above.

Warnings:

Mishandling of small components inside the patient's mouth carries a risk of aspiration and/or swallowing. Fracture of a restoration may occur when an abutment is loaded beyond its functional capability. Reuse of BIOMET **3i** Products that are labeled for single-use may result in product contamination, patient infection and/or failure of the device to perform as intended.

PEEK components are intended for use to support single- or multiple-unit provisional prostheses in the mandible or maxilla for up to 180 days, at which time a definitive prosthesis should be inserted.

Sterility:

Some BIOMET **3i** Restorative Products are supplied sterile. Refer to individual product labels for sterilization information; all sterile products are labeled "STERILE". All products sold sterile are for single-use before the "use by" date printed on the product label. Do not use sterile products if the packaging has been damaged or previously opened. Products provided non-sterile may need to be cleaned and sterilized prior to use. Please refer to the individual product labels or Restorative Manual for more information. For products provided non-sterile

requiring sterilization prior to use, BIOMET **3i** recommends the following sterilization parameters for wrapped items:

Steam gravity sterilization method (gravity-displacement cycle) - Minimum exposure of fifteen (15) minutes timing at a temperature of 270°F (132°C)* **or**

Pre-vacuum sterilization method (dynamic-air-removal cycle) - Minimum exposure of four (4) minutes, four (4) pulses timing at a temperature of 270°F (132°C).*

*Post sterilization, devices should be thoroughly dried for 30 minutes. Please refer to the Surgical and Restorative Manual or package insert for the remaining care and cleaning instructions.

Do not re-sterilize or autoclave components except where indicated on the individual product label, where instructions have been provided in the Restorative Manual or in any additional product literature for the given component.

MRI Statement:

BIOMET **3i** Restorative Products have not been evaluated for safety, heating, migration, or compatibility in the Magnetic Resonance Imaging (MRI) environment.

Precautions:

BIOMET **3i** Restorative Products should only be used by trained professionals. The surgical and restorative techniques required to properly utilize these products are highly specialized and complex procedures. Improper technique can lead to implant failure, loss of supporting bone, restoration fracture, screw loosening and aspiration. Components made from PEEK material are intended for use for up to 180 days.

Potential Adverse Events:

Potential adverse events associated with the use of restorative products may include: failure to integrate; loss of integration; dehiscence requiring bone grafting; infection as reported by: abscess, fistula, suppuration, inflammation, radiolucency; gingival hyperplasia; excessive bone loss requiring intervention; fracture; and nerve injury.

Storage And Handling:

BIOMET **3i** Restorative Products should be stored at room temperature. Refer to the Surgical Manual for special storage or handling conditions.

Caution:

U.S. Federal Law restricts this device to sale by or on the order of a licensed dentist or physician.

Index

Item#	Description	Page#	Item#	Description	Page#
0055	ILIAC CREST STRIP, SMALL	46	ART889	PATIENT ED BROCHURE - IMPLANT RETAINED, LOCATOR® (25-PACK)	48
0056	ILIAC CREST STRIP, LARGE	46	ART890	PATIENT ED BROCHURE - IMPLANT RETAINED, BAR (25-PACK)	48
0473	ILIAC CREST STRIP, MEDIUM	46	ART929	PATIENT ED BROCHURE - IMMEDIATE TEETH REPLACEMENT, DIEM® (25-PACK)	48
0630	RIGHT HEMI MANDIBLE	46	ART930	PATIENT ED CARE CARD (25-PACK)	48
0631	LEFT HEMI MANDIBLE	46	ART943	PATIENT ED FLIP CHART	48
0632	FULL MANDIBLE	46	ART951EUR	PATIENT ED DVD - MULTILINGUAL VERSION	48
0655	DURA MATER-PATCH (MEMBRANE), 4X5CM	46	ART957S	PATIENT ED BROCHURE - BONE LOSS (SPANISH VERSION)	48
0716	FASCIA LATA PATCH (MEMBRANE), 4X5CM	46	ART962	PATIENT ED AWARENESS AND EDUCATION POSTER	48
1454	MINERALIZED CANCELLOUS POWDER, 10CC, 100-200µm	46	BB001	BONE PROFILER ORGANIZER KIT	36
1462	DEMINERALIZED CANCELLOUS POWDER, 10CC, 100-200µm	46	BNES365	3i T3® W/DCD® PARALLEL WALLED IMPLANT, 3.25MM(D) X 6.5MM(L)	7
1465	DEMINERALIZED CORTICAL POWDER, 10CC, 100-200µm	46	BNES385	3i T3 W/DCD PARALLEL WALLED IMPLANT, 3.25MM(D) X 8.5MM(L)	7
1491	DENTAL M&M BLOCK, MEDIUM	46	BNES310	3i T3 W/DCD PARALLEL WALLED IMPLANT, 3.25MM(D) X 10MM(L)	7
1507	DENTAL M&M BLOCK, SMALL	46	BNES311	3i T3 W/DCD PARALLEL WALLED IMPLANT, 3.25MM(D) X 11.5MM(L)	7
1508	DENTAL M&M BLOCK, LARGE	46	BNES313	3i T3 W/DCD PARALLEL WALLED IMPLANT, 3.25MM(D) X 13MM(L)	7
1522	DENTAL M&M BLOCK, IRRADIATED, MEDIUM	46	BNES315	3i T3 W/DCD PARALLEL WALLED IMPLANT, 3.25MM(D) X 15MM(L)	7
1523	DENTAL M&M BLOCK, IRRADIATED, SMALL	46	BNES318	3i T3 W/DCD PARALLEL WALLED IMPLANT, 3.25MM(D) X 18MM(L)	7
1565	DENTAL M&M BLOCK, IRRADIATED, LARGE	46	BNES3765	3i T3 W/DCD PARALLEL WALLED IMPLANT, 3.75MM(D) X 6.5MM(L)	7
3598	SAFESCRAPER® TWIST, STRAIGHT (3-PACK)	47	BNES3785	3i T3 W/DCD PARALLEL WALLED IMPLANT, 3.75MM(D) X 8.5MM(L)	7
3987	SAFESCRAPER TWIST, CURVED (3-PACK)	47	BNES3710	3i T3 W/DCD PARALLEL WALLED IMPLANT, 3.75MM(D) X 10MM(L)	7
2100-0003	BIOGRAN® 500MG MIXING CUP (7-PACK)	47	BNES3711	3i T3 W/DCD PARALLEL WALLED IMPLANT, 3.75MM(D) X 11.5MM(L)	7
2100-0004	BIOGRAN 750MG MIXING CUP (7-PACK)	47	BNES3713	3i T3 W/DCD PARALLEL WALLED IMPLANT, 3.75MM(D) X 13MM(L)	7
2100-0005	BIOGRAN 1500MG MIXING CUP (7-PACK)	47	BNES3715	3i T3 W/DCD PARALLEL WALLED IMPLANT, 3.75MM(D) X 15MM(L)	7
2100-0750	BIOGRAN 750MG MIXING CUP & SYRINGE (1-PACK)	47	BNES3718	3i T3 W/DCD PARALLEL WALLED IMPLANT, 3.75MM(D) X 18MM(L)	7
31-3100	BIOMET 2MM FIXATION SYSTEM	27	BNES465	3i T3 W/DCD PARALLEL WALLED IMPLANT, 4MM(D) X 6.5MM(L)	7
ACT2010	ACT® REUSABLE TWIST DRILL, 2MM X 10MM	30,31,33,35	BNES485	3i T3 W/DCD PARALLEL WALLED IMPLANT, 4MM(D) X 8.5MM(L)	7
ACT2015	ACT REUSABLE TWIST DRILL, 2MM X 15MM	30,31,33,35	BNES410	3i T3 W/DCD PARALLEL WALLED IMPLANT, 4MM(D) X 10MM(L)	7
ACT2020	ACT REUSABLE TWIST DRILL, 2MM X 20MM	30,31,33,35	BNES411	3i T3 W/DCD PARALLEL WALLED IMPLANT, 4MM(D) X 11.5MM(L)	7
ACT2710	ACT REUSABLE TWIST DRILL, 2.75MM X 10MM	31,33,35	BNES413	3i T3 W/DCD PARALLEL WALLED IMPLANT, 4MM(D) X 13MM(L)	7
ACT2715	ACT REUSABLE TWIST DRILL, 2.75MM X 15MM	31,33,35	BNES415	3i T3 W/DCD PARALLEL WALLED IMPLANT, 4MM(D) X 15MM(L)	7
ACT2720	ACT REUSABLE TWIST DRILL, 2.75MM X 20MM	31,33,35	BNES418	3i T3 W/DCD PARALLEL WALLED IMPLANT, 4MM(D) X 18MM(L)	7
ACT3010	ACT REUSABLE TWIST DRILL, 3MM X 10MM	31,33,35	BNES565	3i T3 W/DCD PARALLEL WALLED IMPLANT, 5MM(D) X 6.5MM(L)	7
ACT3015	ACT REUSABLE TWIST DRILL, 3MM X 15MM	31,33,35	BNES585	3i T3 W/DCD PARALLEL WALLED IMPLANT, 5MM(D) X 8.5MM(L)	7
ACT3020	ACT REUSABLE TWIST DRILL, 3MM X 20MM	31,33,35	BNES510	3i T3 W/DCD PARALLEL WALLED IMPLANT, 5MM(D) X 10MM(L)	7
ACT3110	ACT REUSABLE TWIST DRILL, 3.15MM X 10MM	35	BNES511	3i T3 W/DCD PARALLEL WALLED IMPLANT, 5MM(D) X 11.5MM(L)	7
ACT3115	ACT REUSABLE TWIST DRILL, 3.15MM X 15MM	35	BNES513	3i T3 W/DCD PARALLEL WALLED IMPLANT, 5MM(D) X 13MM(L)	7
ACT3120	ACT REUSABLE TWIST DRILL, 3.15MM X 20MM	35	BNES515	3i T3 W/DCD PARALLEL WALLED IMPLANT, 5MM(D) X 15MM(L)	7
ACT3210	ACT REUSABLE TWIST DRILL, 3.25MM X 10MM	31,33,35	BNES518	3i T3 W/DCD PARALLEL WALLED IMPLANT, 5MM(D) X 18MM(L)	7
ACT3215	ACT REUSABLE TWIST DRILL, 3.25MM X 15MM	31,33,35	BNES665	3i T3 W/DCD PARALLEL WALLED IMPLANT, 6MM(D) X 6.5MM(L)	7
ACT3220	ACT REUSABLE TWIST DRILL, 3.25MM X 20MM	31,33,35	BNES685	3i T3 W/DCD PARALLEL WALLED IMPLANT, 6MM(D) X 8.5MM(L)	7
ACT3810	ACT REUSABLE TWIST DRILL, 3.85MM X 10MM	31,35	BNES610	3i T3 W/DCD PARALLEL WALLED IMPLANT, 6MM(D) X 10MM(L)	7
ACT3815	ACT REUSABLE TWIST DRILL, 3.85MM X 15MM	31,35	BNES611	3i T3 W/DCD PARALLEL WALLED IMPLANT, 6MM(D) X 11.5MM(L)	7
ACT3820	ACT REUSABLE TWIST DRILL, 3.85MM X 20MM	31,35	BNES613	3i T3 W/DCD PARALLEL WALLED IMPLANT, 6MM(D) X 13MM(L)	7
ACT4285	ACT REUSABLE TWIST DRILL, 4.25MM X 8.5MM	31,33,35	BNES615	3i T3 W/DCD PARALLEL WALLED IMPLANT, 6MM(D) X 15MM(L)	7
ACT4213	ACT REUSABLE TWIST DRILL, 4.25MM X 13MM	31,33,35	BNES618	3i T3 W/DCD PARALLEL WALLED IMPLANT, 6MM(D) X 18MM(L)	7
ACT4218	ACT REUSABLE TWIST DRILL, 4.25MM X 18MM	31,33,35	BNET3285	3i T3 W/DCD TAPERED IMPLANT, 3.25MM(D) X 8.5MM(L)	7
ACT4885	ACT REUSABLE TWIST DRILL, 4.85MM X 8.5MM	31,35	BNET3210	3i T3 W/DCD TAPERED IMPLANT, 3.25MM(D) X 10MM(L)	7
ACT4813	ACT REUSABLE TWIST DRILL, 4.85MM X 13MM	31,35	BNET3211	3i T3 W/DCD TAPERED IMPLANT, 3.25MM(D) X 11.5MM(L)	7
ACT4818	ACT REUSABLE TWIST DRILL, 4.85MM X 18MM	31,35	BNET3213	3i T3 W/DCD TAPERED IMPLANT, 3.25MM(D) X 13MM(L)	7
ACT5285	ACT REUSABLE TWIST DRILL, 5.25MM X 8.5MM	31,33,35	BNET3215	3i T3 W/DCD TAPERED IMPLANT, 3.25MM(D) X 15MM(L)	7
ACT5213	ACT REUSABLE TWIST DRILL, 5.25MM X 13MM	31,33,35	BNET485	3i T3 W/DCD TAPERED IMPLANT, 4MM(D) X 8.5MM(L)	7
ACT5218	ACT REUSABLE TWIST DRILL, 5.25MM X 18MM	31,33,35	BNET410	3i T3 W/DCD TAPERED IMPLANT, 4MM(D) X 10MM(L)	7
ACTDE	ACT DRILL EXTENSION	30,31,33,40	BNET411	3i T3 W/DCD TAPERED IMPLANT, 4MM(D) X 11.5MM(L)	7
ACTPSD	ACT POINTED STARTER DRILL	31,35	BNET413	3i T3 W/DCD TAPERED IMPLANT, 4MM(D) X 13MM(L)	7
ART1178	PATIENT ED REGENERATIVE BROCHURE	48	BNET415	3i T3 W/DCD TAPERED IMPLANT, 4MM(D) X 15MM(L)	7
ART885	PATIENT ED BROCHURE - BONE LOSS (25-PACK)	48	BNET585	3i T3 W/DCD TAPERED IMPLANT, 5MM(D) X 8.5MM(L)	7
ART887	PATIENT ED BROCHURE - MULTIPLE TEETH (25-PACK)	48	BNET510	3i T3 W/DCD TAPERED IMPLANT, 5MM(D) X 10MM(L)	7
ART888	PATIENT ED BROCHURE - IMPLANT RETAINED, FIXED (25-PACK)	48	BNET511	3i T3 W/DCD TAPERED IMPLANT, 5MM(D) X 11.5MM(L)	7

Index

Item#	Description	Page#	Item#	Description	Page#
BNET513	3i T3® W/DCD® TAPERED IMPLANT, 5MM(D) X 13MM(L)	7	BNSS318	3i T3 W/DCD NON-PLATFORM SWITCHED PARALLEL WALLED IMPLANT, 2 3.25MM(D) X 18MM(L)	2
BNET515	3i T3 W/DCD TAPERED IMPLANT, 5MM(D) X 15MM(L)	7	BNSS385	3i T3 W/DCD NON-PLATFORM SWITCHED PARALLEL WALLED IMPLANT, 2 3.25MM(D) X 8.5MM(L)	2
BNET685	3i T3 W/DCD TAPERED IMPLANT, 6MM(D) X 8.5MM(L)	7	BNSS410	3i T3 W/DCD NON-PLATFORM SWITCHED PARALLEL WALLED IMPLANT, 2 4MM(D) X 10MM(L)	2
BNET610	3i T3 W/DCD TAPERED IMPLANT, 6MM(D) X 10MM(L)	7	BNSS411	3i T3 W/DCD NON-PLATFORM SWITCHED PARALLEL WALLED IMPLANT, 2 4MM(D) X 11.5MM(L)	2
BNET611	3i T3 W/DCD TAPERED IMPLANT, 6MM(D) X 11.5MM(L)	7	BNSS413	3i T3 W/DCD NON-PLATFORM SWITCHED PARALLEL WALLED IMPLANT, 2 4MM(D) X 13MM(L)	2
BNET613	3i T3 W/DCD TAPERED IMPLANT, 6MM(D) X 13MM(L)	7	BNSS415	3i T3 W/DCD NON-PLATFORM SWITCHED PARALLEL WALLED IMPLANT, 2 4MM(D) X 15MM(L)	2
BNET615	3i T3 W/DCD TAPERED IMPLANT, 6MM(D) X 15MM(L)	7	BNSS418	3i T3 W/DCD NON-PLATFORM SWITCHED PARALLEL WALLED IMPLANT, 2 4MM(D) X 18MM(L)	2
BNPS4310	3i T3 W/DCD PLATFORM SWITCHED PARALLEL WALLED IMPLANT, 4/3 X 10MM(L)	2	BNSS485	3i T3 W/DCD NON-PLATFORM SWITCHED PARALLEL WALLED IMPLANT, 2 4MM(D) X 8.5MM(L)	2
BNPS4311	3i T3 W/DCD PLATFORM SWITCHED PARALLEL WALLED IMPLANT, 4/3 X 11.5MM(L)	2	BNSS510	3i T3 W/DCD NON-PLATFORM SWITCHED PARALLEL WALLED IMPLANT, 2 5MM(D) X 10MM(L)	2
BNPS4313	3i T3 W/DCD PLATFORM SWITCHED PARALLEL WALLED IMPLANT, 4/3 X 13MM(L)	2	BNSS511	3i T3 W/DCD NON-PLATFORM SWITCHED PARALLEL WALLED IMPLANT, 2 5MM(D) X 11.5MM(L)	2
BNPS4315	3i T3 W/DCD PLATFORM SWITCHED PARALLEL WALLED IMPLANT, 4/3 X 15MM(L)	2	BNSS513	3i T3 W/DCD NON-PLATFORM SWITCHED PARALLEL WALLED IMPLANT, 2 5MM(D) X 13MM(L)	2
BNPS4385	3i T3 W/DCD PLATFORM SWITCHED PARALLEL WALLED IMPLANT, 4/3 X 8.5MM(L)	2	BNSS515	3i T3 W/DCD NON-PLATFORM SWITCHED PARALLEL WALLED IMPLANT, 2 5MM(D) X 15MM(L)	2
BNPS5410	3i T3 W/DCD PLATFORM SWITCHED PARALLEL WALLED IMPLANT, 5/4 X 10MM(L)	2	BNSS585	3i T3 W/DCD NON-PLATFORM SWITCHED PARALLEL WALLED IMPLANT, 2 5MM(D) X 8.5MM(L)	2
BNPS5411	3i T3 W/DCD PLATFORM SWITCHED PARALLEL WALLED IMPLANT, 5/4 X 11.5MM(L)	2	BNSS610	3i T3 W/DCD NON-PLATFORM SWITCHED PARALLEL WALLED IMPLANT, 2 6MM(D) X 10MM(L)	2
BNPS5413	3i T3 W/DCD PLATFORM SWITCHED PARALLEL WALLED IMPLANT, 5/4 X 13MM(L)	2	BNSS611	3i T3 W/DCD NON-PLATFORM SWITCHED PARALLEL WALLED IMPLANT, 2 6MM(D) X 11.5MM(L)	2
BNPS5415	3i T3 W/DCD PLATFORM SWITCHED PARALLEL WALLED IMPLANT, 5/4 X 15MM(L)	2	BNSS613	3i T3 W/DCD NON-PLATFORM SWITCHED PARALLEL WALLED IMPLANT, 2 6MM(D) X 13MM(L)	2
BNPS5485	3i T3 W/DCD PLATFORM SWITCHED PARALLEL WALLED IMPLANT, 5/4 X 8.5MM(L)	2	BNSS615	3i T3 W/DCD NON-PLATFORM SWITCHED PARALLEL WALLED IMPLANT, 2 6MM(D) X 15MM(L)	2
BNPS6510	3i T3 W/DCD PLATFORM SWITCHED PARALLEL WALLED IMPLANT, 6/5 X 10MM(L)	2	BNSS685	3i T3 W/DCD NON-PLATFORM SWITCHED PARALLEL WALLED IMPLANT, 2 6MM(D) X 8.5MM(L)	2
BNPS6511	3i T3 W/DCD PLATFORM SWITCHED PARALLEL WALLED IMPLANT, 6/5 X 11.5MM(L)	2	BNST3210	3i T3 W/DCD NON-PLATFORM SWITCHED TAPERED IMPLANT, 3.25MM(D) X 10MM(L)	1
BNPS6513	3i T3 W/DCD PLATFORM SWITCHED PARALLEL WALLED IMPLANT, 6/5 X 13MM(L)	2	BNST3211	3i T3 W/DCD NON-PLATFORM SWITCHED TAPERED IMPLANT, 3.25MM(D) X 11.5MM(L)	1
BNPS6515	3i T3 W/DCD PLATFORM SWITCHED PARALLEL WALLED IMPLANT, 6/5 X 15MM(L)	2	BNST3213	3i T3 W/DCD NON-PLATFORM SWITCHED TAPERED IMPLANT, 3.25MM(D) X 13MM(L)	1
BNPS6585	3i T3 W/DCD PLATFORM SWITCHED PARALLEL WALLED IMPLANT, 6/5 X 8.5MM(L)	2	BNST3215	3i T3 W/DCD NON-PLATFORM SWITCHED TAPERED IMPLANT, 3.25MM(D) X 15MM(L)	1
BNPT4310	3i T3 W/DCD PLATFORM SWITCHED TAPERED IMPLANT, 4/3 X 10MM(L)	1	BNST3285	3i T3 W/DCD NON-PLATFORM SWITCHED TAPERED IMPLANT, 3.25MM(D) X 8.5MM(L)	1
BNPT4311	3i T3 W/DCD PLATFORM SWITCHED TAPERED IMPLANT, 4/3 X 11.5MM(L)	1	BNST410	3i T3 W/DCD NON-PLATFORM SWITCHED TAPERED IMPLANT, 4MM(D) X 10MM(L)	1
BNPT4313	3i T3 W/DCD PLATFORM SWITCHED TAPERED IMPLANT, 4/3 X 13MM(L)	1	BNST411	3i T3 W/DCD NON-PLATFORM SWITCHED TAPERED IMPLANT, 4MM(D) X 11.5MM(L)	1
BNPT4315	3i T3 W/DCD PLATFORM SWITCHED TAPERED IMPLANT, 4/3 X 15MM(L)	1	BNST413	3i T3 W/DCD NON-PLATFORM SWITCHED TAPERED IMPLANT, 4MM(D) X 13MM(L)	1
BNPT4385	3i T3 W/DCD PLATFORM SWITCHED TAPERED IMPLANT, 4/3 X 8.5MM(L)	1	BNST415	3i T3 W/DCD NON-PLATFORM SWITCHED TAPERED IMPLANT, 4MM(D) X 15MM(L)	1
BNPT5410	3i T3 W/DCD PLATFORM SWITCHED TAPERED IMPLANT, 5/4 X 10MM(L)	1	BNST485	3i T3 W/DCD NON-PLATFORM SWITCHED TAPERED IMPLANT, 4MM(D) X 8.5MM(L)	1
BNPT5411	3i T3 W/DCD PLATFORM SWITCHED TAPERED IMPLANT, 5/4 X 11.5MM(L)	1	BNST510	3i T3 W/DCD NON-PLATFORM SWITCHED TAPERED IMPLANT, 5MM(D) X 10MM(L)	1
BNPT5413	3i T3 W/DCD PLATFORM SWITCHED TAPERED IMPLANT, 5/4 X 13MM(L)	1	BNST511	3i T3 W/DCD NON-PLATFORM SWITCHED TAPERED IMPLANT, 5MM(D) X 11.5MM(L)	1
BNPT5415	3i T3 W/DCD PLATFORM SWITCHED TAPERED IMPLANT, 5/4 X 15MM(L)	1			
BNPT5485	3i T3 W/DCD PLATFORM SWITCHED TAPERED IMPLANT, 5/4 X 8.5MM(L)	1			
BNPT6510	3i T3 W/DCD PLATFORM SWITCHED TAPERED IMPLANT, 6/5 X 10MM(L)	1			
BNPT6511	3i T3 W/DCD PLATFORM SWITCHED TAPERED IMPLANT, 6/5 X 11.5MM(L)	1			
BNPT6513	3i T3 W/DCD PLATFORM SWITCHED TAPERED IMPLANT, 6/5 X 13MM(L)	1			
BNPT6515	3i T3 W/DCD PLATFORM SWITCHED TAPERED IMPLANT, 6/5 X 15MM(L)	1			
BNPT6585	3i T3 W/DCD PLATFORM SWITCHED TAPERED IMPLANT, 6/5 X 8.5MM(L)	1			
BNSS310	3i T3 W/DCD NON-PLATFORM SWITCHED PARALLEL WALLED IMPLANT, 2 3.25MM(D) X 10MM(L)	2			
BNSS311	3i T3 W/DCD NON-PLATFORM SWITCHED PARALLEL WALLED IMPLANT, 2 3.25MM(D) X 11.5MM(L)	2			
BNSS313	3i T3 W/DCD NON-PLATFORM SWITCHED PARALLEL WALLED IMPLANT, 2 3.25MM(D) X 13MM(L)	2			
BNSS315	3i T3 W/DCD NON-PLATFORM SWITCHED PARALLEL WALLED IMPLANT, 2 3.25MM(D) X 15MM(L)	2			

Index

Item#	Description	Page#	Item#	Description	Page#
BNST513	3i T3® W/DCD® NON-PLATFORM SWITCHED TAPERED IMPLANT, 5MM(D) X 13MM(L)	1	BOET411	3i T3 TAPERED IMPLANT, 4MM(D) X 11.5MM(L)	7
BNST515	3i T3 W/DCD NON-PLATFORM SWITCHED TAPERED IMPLANT, 5MM(D) X 15MM(L)	1	BOET413	3i T3 TAPERED IMPLANT, 4MM(D) X 13MM(L)	7
BNST585	3i T3 W/DCD NON-PLATFORM SWITCHED TAPERED IMPLANT, 5MM(D) X 8.5MM(L)	1	BOET415	3i T3 TAPERED IMPLANT, 4MM(D) X 15MM(L)	7
BNST610	3i T3 W/DCD NON-PLATFORM SWITCHED TAPERED IMPLANT, 6MM(D) X 10MM(L)	1	BOET585	3i T3 TAPERED IMPLANT, 5MM(D) X 8.5MM(L)	7
BNST611	3i T3 W/DCD NON-PLATFORM SWITCHED TAPERED IMPLANT, 6MM(D) X 11.5MM(L)	1	BOET510	3i T3 TAPERED IMPLANT, 5MM(D) X 10MM(L)	7
BNST613	3i T3 W/DCD NON-PLATFORM SWITCHED TAPERED IMPLANT, 6MM(D) X 13MM(L)	1	BOET511	3i T3 TAPERED IMPLANT, 5MM(D) X 11.5MM(L)	7
BNST615	3i T3 W/DCD NON-PLATFORM SWITCHED TAPERED IMPLANT, 6MM(D) X 15MM(L)	1	BOET513	3i T3 TAPERED IMPLANT, 5MM(D) X 13MM(L)	7
BNST685	3i T3 W/DCD NON-PLATFORM SWITCHED TAPERED IMPLANT, 6MM(D) X 8.5MM(L)	1	BOET515	3i T3 TAPERED IMPLANT, 5MM(D) X 15MM(L)	7
BOES365	3i T3 PARALLEL WALLED IMPLANT, 3.25MM(D) X 6.5MM(L)	7	BOET685	3i T3 TAPERED IMPLANT, 6MM(D) X 8.5MM(L)	7
BOES385	3i T3 PARALLEL WALLED IMPLANT, 3.25MM(D) X 8.5MM(L)	7	BOET610	3i T3 TAPERED IMPLANT, 6MM(D) X 10MM(L)	7
BOES310	3i T3 PARALLEL WALLED IMPLANT, 3.25MM(D) X 10MM(L)	7	BOET611	3i T3 TAPERED IMPLANT, 6MM(D) X 11.5MM(L)	7
BOES311	3i T3 PARALLEL WALLED IMPLANT, 3.25MM(D) X 11.5MM(L)	7	BOET613	3i T3 TAPERED IMPLANT, 6MM(D) X 13MM(L)	7
BOES313	3i T3 PARALLEL WALLED IMPLANT, 3.25MM(D) X 13MM(L)	7	BOET615	3i T3 TAPERED IMPLANT, 6MM(D) X 15MM(L)	7
BOES315	3i T3 PARALLEL WALLED IMPLANT, 3.25MM(D) X 15MM(L)	7	BOPS4310	3i T3 PLATFORM SWITCHED PARALLEL WALLED IMPLANT, 4/3 X 10MM(L)	2
BOES318	3i T3 PARALLEL WALLED IMPLANT, 3.25MM(D) X 18MM(L)	7	BOPS4311	3i T3 PLATFORM SWITCHED PARALLEL WALLED IMPLANT, 4/3 X 11.5MM(L)	2
BOES3765	3i T3 PARALLEL WALLED IMPLANT, 3.75MM(D) X 6.5MM(L)	7	BOPS4313	3i T3 PLATFORM SWITCHED PARALLEL WALLED IMPLANT, 4/3 X 13MM(L)	2
BOES3785	3i T3 PARALLEL WALLED IMPLANT, 3.75MM(D) X 8.5MM(L)	7	BOPS4315	3i T3 PLATFORM SWITCHED PARALLEL WALLED IMPLANT, 4/3 X 15MM(L)	2
BOES3710	3i T3 PARALLEL WALLED IMPLANT, 3.75MM(D) X 10MM(L)	7	BOPS4385	3i T3 PLATFORM SWITCHED PARALLEL WALLED IMPLANT, 4/3 X 8.5MM(L)	2
BOES3711	3i T3 PARALLEL WALLED IMPLANT, 3.75MM(D) X 11.5MM(L)	7	BOPS5410	3i T3 PLATFORM SWITCHED PARALLEL WALLED IMPLANT, 5/4 X 10MM(L)	2
BOES3713	3i T3 PARALLEL WALLED IMPLANT, 3.75MM(D) X 13MM(L)	7	BOPS5411	3i T3 PLATFORM SWITCHED PARALLEL WALLED IMPLANT, 5/4 X 11.5MM(L)	2
BOES3715	3i T3 PARALLEL WALLED IMPLANT, 3.75MM(D) X 15MM(L)	7	BOPS5413	3i T3 PLATFORM SWITCHED PARALLEL WALLED IMPLANT, 5/4 X 13MM(L)	2
BOES3718	3i T3 PARALLEL WALLED IMPLANT, 3.75MM(D) X 18MM(L)	7	BOPS5415	3i T3 PLATFORM SWITCHED PARALLEL WALLED IMPLANT, 5/4 X 15MM(L)	2
BOES465	3i T3 PARALLEL WALLED IMPLANT, 4MM(D) X 6.5MM(L)	7	BOPS5485	3i T3 PLATFORM SWITCHED PARALLEL WALLED IMPLANT, 5/4 X 8.5MM(L)	2
BOES485	3i T3 PARALLEL WALLED IMPLANT, 4MM(D) X 8.5MM(L)	7	BOPS6510	3i T3 PLATFORM SWITCHED PARALLEL WALLED IMPLANT, 6/5 X 10MM(L)	2
BOES410	3i T3 PARALLEL WALLED IMPLANT, 4MM(D) X 10MM(L)	7	BOPS6511	3i T3 PLATFORM SWITCHED PARALLEL WALLED IMPLANT, 6/5 X 11.5MM(L)	2
BOES411	3i T3 PARALLEL WALLED IMPLANT, 4MM(D) X 11.5MM(L)	7	BOPS6513	3i T3 PLATFORM SWITCHED PARALLEL WALLED IMPLANT, 6/5 X 13MM(L)	2
BOES413	3i T3 PARALLEL WALLED IMPLANT, 4MM(D) X 13MM(L)	7	BOPS6515	3i T3 PLATFORM SWITCHED PARALLEL WALLED IMPLANT, 6/5 X 15MM(L)	2
BOES415	3i T3 PARALLEL WALLED IMPLANT, 4MM(D) X 15MM(L)	7	BOPS6585	3i T3 PLATFORM SWITCHED PARALLEL WALLED IMPLANT, 6/5 X 8.5MM(L)	2
BOES418	3i T3 PARALLEL WALLED IMPLANT, 4MM(D) X 18MM(L)	7	BOPT4310	3i T3 PLATFORM SWITCHED TAPERED IMPLANT, 4/3 X 10MM(L)	1
BOES565	3i T3 PARALLEL WALLED IMPLANT, 5MM(D) X 6.5MM(L)	7	BOPT4311	3i T3 PLATFORM SWITCHED TAPERED IMPLANT, 4/3 X 11.5MM(L)	1
BOES585	3i T3 PARALLEL WALLED IMPLANT, 5MM(D) X 8.5MM(L)	7	BOPT4313	3i T3 PLATFORM SWITCHED TAPERED IMPLANT, 4/3 X 13MM(L)	1
BOES510	3i T3 PARALLEL WALLED IMPLANT, 5MM(D) X 10MM(L)	7	BOPT4315	3i T3 PLATFORM SWITCHED TAPERED IMPLANT, 4/3 X 15MM(L)	1
BOES511	3i T3 PARALLEL WALLED IMPLANT, 5MM(D) X 11.5MM(L)	7	BOPT4385	3i T3 PLATFORM SWITCHED TAPERED IMPLANT, 4/3 X 8.5MM(L)	1
BOES513	3i T3 PARALLEL WALLED IMPLANT, 5MM(D) X 13MM(L)	7	BOPT5410	3i T3 PLATFORM SWITCHED TAPERED IMPLANT, 5/4 X 10MM(L)	1
BOES515	3i T3 PARALLEL WALLED IMPLANT, 5MM(D) X 15MM(L)	7	BOPT5411	3i T3 PLATFORM SWITCHED TAPERED IMPLANT, 5/4 X 11.5MM(L)	1
BOES518	3i T3 PARALLEL WALLED IMPLANT, 5MM(D) X 18MM(L)	7	BOPT5413	3i T3 PLATFORM SWITCHED TAPERED IMPLANT, 5/4 X 13MM(L)	1
BOES665	3i T3 PARALLEL WALLED IMPLANT, 6MM(D) X 6.5MM(L)	7	BOPT5415	3i T3 PLATFORM SWITCHED TAPERED IMPLANT, 5/4 X 15MM(L)	1
BOES685	3i T3 PARALLEL WALLED IMPLANT, 6MM(D) X 8.5MM(L)	7	BOPT6510	3i T3 PLATFORM SWITCHED TAPERED IMPLANT, 6/5 X 8.5MM(L)	1
BOES610	3i T3 PARALLEL WALLED IMPLANT, 6MM(D) X 10MM(L)	7	BOPT6511	3i T3 PLATFORM SWITCHED TAPERED IMPLANT, 6/5 X 10MM(L)	1
BOES611	3i T3 PARALLEL WALLED IMPLANT, 6MM(D) X 11.5MM(L)	7	BOPT6513	3i T3 PLATFORM SWITCHED TAPERED IMPLANT, 6/5 X 11.5MM(L)	1
BOES613	3i T3 PARALLEL WALLED IMPLANT, 6MM(D) X 13MM(L)	7	BOPT6515	3i T3 PLATFORM SWITCHED TAPERED IMPLANT, 6/5 X 15MM(L)	1
BOES615	3i T3 PARALLEL WALLED IMPLANT, 6MM(D) X 15MM(L)	7	BOPT6585	3i T3 PLATFORM SWITCHED TAPERED IMPLANT, 6/5 X 8.5MM(L)	1
BOES618	3i T3 PARALLEL WALLED IMPLANT, 6MM(D) X 18MM(L)	7	BOSS310	3i T3 NON-PLATFORM SWITCHED PARALLEL WALLED IMPLANT, 3.25MM(D) X 10MM(L)	2
BOET3285	3i T3 TAPERED IMPLANT, 3.25MM(D) X 8.5MM(L)	7	BOSS311	3i T3 NON-PLATFORM SWITCHED PARALLEL WALLED IMPLANT, 3.25MM(D) X 11.5MM(L)	2
BOET3210	3i T3 TAPERED IMPLANT, 3.25MM(D) X 10MM(L)	7	BOSS313	3i T3 NON-PLATFORM SWITCHED PARALLEL WALLED IMPLANT, 3.25MM(D) X 13MM(L)	2
BOET3211	3i T3 TAPERED IMPLANT, 3.25MM(D) X 11.5MM(L)	7	BOSS315	3i T3 NON-PLATFORM SWITCHED PARALLEL WALLED IMPLANT, 3.25MM(D) X 15MM(L)	2
BOET3213	3i T3 TAPERED IMPLANT, 3.25MM(D) X 13MM(L)	7	BOSS318	3i T3 NON-PLATFORM SWITCHED PARALLEL WALLED IMPLANT, 3.25MM(D) X 18MM(L)	2
BOET3215	3i T3 TAPERED IMPLANT, 3.25MM(D) X 15MM(L)	7	BOSS385	3i T3 NON-PLATFORM SWITCHED PARALLEL WALLED IMPLANT, 3.25MM(D) X 8.5MM(L)	2
BOET485	3i T3 TAPERED IMPLANT, 4MM(D) X 8.5MM(L)	7	BOSS410	3i T3 NON-PLATFORM SWITCHED PARALLEL WALLED IMPLANT, 4MM(D) X 10MM(L)	2
BOET410	3i T3 TAPERED IMPLANT, 4MM(D) X 10MM(L)	7			

Index

Item#	Description	Page#	Item#	Description	Page#
BOSS411	3i T3® NON-PLATFORM SWITCHED PARALLEL WALLED IMPLANT, 4MM(D) X 11.5MM(L)	2	BP560	BONE PROFILER W/GUIDE PIN, 5MM(D) X 6MM(P)	36
BOSS413	3i T3 NON-PLATFORM SWITCHED PARALLEL WALLED IMPLANT, 4MM(D) X 13MM(L)	2	BP575	BONE PROFILER W/GUIDE PIN, 5MM(D) X 7.5MM(P)	36
BOSS415	3i T3 NON-PLATFORM SWITCHED PARALLEL WALLED IMPLANT, 4MM(D) X 15MM(L)	2	BP660	BONE PROFILER W/GUIDE PIN, 6MM(D) X 6MM(P)	36
BOSS418	3i T3 NON-PLATFORM SWITCHED PARALLEL WALLED IMPLANT, 4MM(D) X 18MM(L)	2	BP675	BONE PROFILER W/GUIDE PIN, 6MM(D) X 7.5MM(P)	36
BOSS485	3i T3 NON-PLATFORM SWITCHED PARALLEL WALLED IMPLANT, 4MM(D) X 8.5MM(L)	2	BPAKT	BONE PROFILER KIT, 5 & 6MM(D)	36
BOSS510	3i T3 NON-PLATFORM SWITCHED PARALLEL WALLED IMPLANT, 5MM(D) X 10MM(L)	2	BPAKTB	BONE PROFILER ORGANIZER BOX, 5 & 6MM(D)	36
BOSS511	3i T3 NON-PLATFORM SWITCHED PARALLEL WALLED IMPLANT, 5MM(D) X 11.5MM(L)	2	BPGUIDE	BONE PROFILER GUIDE PIN, 3.4, 4.1, 5 & 6MM(D)	36
BOSS513	3i T3 NON-PLATFORM SWITCHED PARALLEL WALLED IMPLANT, 5MM(D) X 13MM(L)	2	BPKIT	BONE PROFILER KIT, 4.1MM(D)	36
BOSS515	3i T3 NON-PLATFORM SWITCHED PARALLEL WALLED IMPLANT, 5MM(D) X 15MM(L)	2	BPKITB	BONE PROFILER ORGANIZER BOX, 4.1MM(D)	36
BOSS585	3i T3 NON-PLATFORM SWITCHED PARALLEL WALLED IMPLANT, 5MM(D) X 8.5MM(L)	2	C202-750	OSSEOCISION® TUBE CLAMP	20
BOSS610	3i T3 NON-PLATFORM SWITCHED PARALLEL WALLED IMPLANT, 6MM(D) X 10MM(L)	2	C293-025	OSSEOCISION INTERNAL IRRIGATION TUBE	20
BOSS611	3i T3 NON-PLATFORM SWITCHED PARALLEL WALLED IMPLANT, 6MM(D) X 11.5MM(L)	2	C823-752	OSSEOCISION Y-CONNECTOR	20
BOSS613	3i T3 NON-PLATFORM SWITCHED PARALLEL WALLED IMPLANT, 6MM(D) X 13MM(L)	2	CD100	COUNTERSINK REUSABLE DRILL, 4.1MM EXTERNAL CONNECTION	32,33,35
BOSS615	3i T3 NON-PLATFORM SWITCHED PARALLEL WALLED IMPLANT, 6MM(D) X 15MM(L)	2	CD4500	COUNTERSINK REUSABLE DRILL, 4/5, 4/5/4MM	31,33,35
BOSS685	3i T3 NON-PLATFORM SWITCHED PARALLEL WALLED IMPLANT, 6MM(D) X 8.5MM(L)	2	CD500	COUNTERSINK/PILOT REUSABLE DRILL, 5MM	31,33,35
BOST3210	3i T3 NON-PLATFORM SWITCHED TAPERED IMPLANT, 3.25MM(D) X 10MM(L)	1	CD5600	COUNTERSINK/PILOT REUSABLE DRILL, 5/6, 5/4/5MM	31,33,35
BOST3211	3i T3 NON-PLATFORM SWITCHED TAPERED IMPLANT, 3.25MM(D) X 11.5MM(L)	1	CD600	COUNTERSINK/PILOT REUSABLE DRILL, 4.25–5.25MM	32,33,35
BOST3213	3i T3 NON-PLATFORM SWITCHED TAPERED IMPLANT, 3.25MM(D) X 13MM(L)	1	CS275	HEADLESS COVER SCREW, 4.1, 5, 6MM(D)	7,8,9,10
BOST3215	3i T3 NON-PLATFORM SWITCHED TAPERED IMPLANT, 3.25MM(D) X 15MM(L)	1	CS375	IMPLANT COVER SCREW, 4.1MM(D) X 1MM(H)	7,8,9,10
BOST3285	3i T3 NON-PLATFORM SWITCHED TAPERED IMPLANT, 3.25MM(D) X 8.5MM(L)	1	CS500	IMPLANT COVER SCREW, 5MM(D) X 1MM(H)	7,8,9,10
BOST410	3i T3 NON-PLATFORM SWITCHED TAPERED IMPLANT, 4MM(D) X 10MM(L)	1	CS600	IMPLANT COVER SCREW, 6MM(D) X 1MM(H)	7,8,9,10
BOST411	3i T3 NON-PLATFORM SWITCHED TAPERED IMPLANT, 4MM(D) X 11.5MM(L)	1	CW100	OPEN END WRENCH	22,26,29,32,34,39
BOST413	3i T3 NON-PLATFORM SWITCHED TAPERED IMPLANT, 4MM(D) X 13MM(L)	1	DC100	COUNTERSINK DISPOSABLE DRILL, 4.1MM EXTERNAL CONNECTION	35
BOST415	3i T3 NON-PLATFORM SWITCHED TAPERED IMPLANT, 4MM(D) X 15MM(L)	1	DC500	PILOT/COUNTERSINK DISPOSABLE DRILL, 5MM	35
BOST485	3i T3 NON-PLATFORM SWITCHED TAPERED IMPLANT, 4MM(D) X 8.5MM(L)	1	DC600	PILOT/COUNTERSINK DISPOSABLE DRILL, 6MM	35
BOST510	3i T3 NON-PLATFORM SWITCHED TAPERED IMPLANT, 5MM(D) X 10MM(L)	1	DIEM2-4UNIT	PATIENT ED MODEL - DIEM®2 (4-UNIT)	48
BOST511	3i T3 NON-PLATFORM SWITCHED TAPERED IMPLANT, 5MM(D) X 11.5MM(L)	1	DIEM2-6UNIT	PATIENT ED MODEL - DIEM®2 (6-UNIT)	48
BOST513	3i T3 NON-PLATFORM SWITCHED TAPERED IMPLANT, 5MM(D) X 13MM(L)	1	DI100	DIRECTION INDICATOR, 2MM(D) X 10MM(L), 3EA.	30,32,34,38
BOST515	3i T3 NON-PLATFORM SWITCHED TAPERED IMPLANT, 5MM(D) X 15MM(L)	1	DI200	DIRECTION INDICATOR, 2MM(D) X 15MM(L)	38
BOST585	3i T3 NON-PLATFORM SWITCHED TAPERED IMPLANT, 5MM(D) X 8.5MM(L)	1	DI2310	DIRECTION INDICATOR, 2.3MM(D) X 10MM(L)	38
BOST610	3i T3 NON-PLATFORM SWITCHED TAPERED IMPLANT, 6MM(D) X 10MM(L)	1	DI2315	DIRECTION INDICATOR, 2.3MM(D) X 15MM(L)	38
BOST611	3i T3 NON-PLATFORM SWITCHED TAPERED IMPLANT, 6MM(D) X 11.5MM(L)	1	DP020	IMPLANT DEPTH GAUGE, 20MM(L)	29,32,34,39
BOST613	3i T3 NON-PLATFORM SWITCHED TAPERED IMPLANT, 6MM(D) X 13MM(L)	1	DP100	DISPOSABLE PILOT DRILL, 2-3MM	35
BOST615	3i T3 NON-PLATFORM SWITCHED TAPERED IMPLANT, 6MM(D) X 15MM(L)	1	DR100	DISPOSABLE ROUND BUR	35
BOST685	3i T3 NON-PLATFORM SWITCHED TAPERED IMPLANT, 6MM(D) X 8.5MM(L)	1	DS100J	OSSEOCISION SURGICAL DRILL SYSTEM (100V) W/HANDPIECE	20
BP340	BONE PROFILER W/GUIDE PIN, 3.4MM(D) X 3.8MM(P)	36	DS100RW	OSSEOCISION SURGICAL DRILL SYSTEM (230V) W/HANDPIECE	20
BP450	BONE PROFILER W/GUIDE PIN, 4.1MM(D) X 5MM(P)	36	DS100US	OSSEOCISION SURGICAL DRILL SYSTEM (120V) W/HANDPIECE	20
BP460	BONE PROFILER W/GUIDE PIN, 4.1MM(D) X 6MM(P)	36	DU1000US	DU1000 SURGICAL DRILLING UNIT, 115 VOLT (USA)	19
BP475	BONE PROFILER W/GUIDE PIN, 4.1MM(D) X 7.5MM(P)	36	DU1000EU	DU1000 SURGICAL DRILLING UNIT, 230 VOLT (EUROPE)	19
BP550	BONE PROFILER W/GUIDE PIN, 5MM(D) X 5MM(P)	36	DU1KFC	DU1000 FOOT CONTROL	19
			DU1KH1	DU1000 HANDLE FOR FOOT CONTROL	19
			DU1KHS	DU1000 MOTOR/HANDPIECE SUPPORT	19
			DU1KIT	DU1000 DISPOSABLE IRRIGATION TUBING SET (6-PIECE)	19
			DU1KMC	DU1000 MICROMOTOR WITH CABLE	19
			DU1KPCCH	DU1000 ELECTRICAL POWER CORD (SWITZERLAND)	19
			DU1KPCDK	DU1000 ELECTRICAL POWER CORD (DENMARK)	19
			DU9BG	DU1000 BUR TESTING GAUGE	19
			DU9CL	DU1000 IRRIGATION TUBE CLAMPS (5-PACK)	19
			DU9F	DU1000 CIRCUIT FUSE	19
			DU9IBS	DU1000 IRRIGATION BAG STAND	19
			DU9LP	DU1000 LOCKING PIN	19
			DU9NC	DU1000 NOZZLE CLEANER	19
			DU9PCAU	DU1000 ELECTRICAL POWER CORD (AUSTRALIA, NEW ZEALAND)	19
			DU9PCEU	DU1000 ELECTRICAL POWER CORD (EUROPE)	19
			DU9PCUK	DU1000 ELECTRICAL POWER CORD (UNITED KINGDOM, IRELAND)	19
			DU9SC	DU1000 SPRAY CAP WITH NOZZLE	19
			DU9SP	DU1000 MOTOR PROTECTIVE COVER	19

Index

Item#	Description	Page#	Item#	Description	Page#
DU9WI75L	DU1000 20:1 HANDPIECE	19	EHA566	BELLATEK ENCODE 2-PC HEALING ABUTMENT, 5MM(D) X 6MM(P) X 6MM(H)	15
DU9WS75	DU1000 20:1 HANDPIECE	19	EHA568	BELLATEK ENCODE 2-PC HEALING ABUTMENT, 5MM(D) X 6MM(P) X 8MM(H)	15
DU9YC	DU1000 Y-CONNECTOR (3-PACK)	19	EHA663	BELLATEK ENCODE 2-PC HEALING ABUTMENT, 6MM(D) X 6MM(P) X 3MM(H)	15
DU9PCUS	DU1000 ELECTRICAL POWER CORD (USA, CANADA, JAPAN)	19	EHA664	BELLATEK ENCODE 2-PC HEALING ABUTMENT, 6MM(D) X 6MM(P) X 4MM(H)	15
E211-001	OSSEOCISION® MICROMOTOR W/CORD	20	EHA666	BELLATEK ENCODE 2-PC HEALING ABUTMENT, 6MM(D) X 6MM(P) X 6MM(H)	15
E211-051	OSSEOCISION MOTOR CORD	20	EHA668	BELLATEK ENCODE 2-PC HEALING ABUTMENT, 6MM(D) X 6MM(P) X 8MM(H)	15
E211-701	OSSEOCISION AUTOCLAVE PLUG FOR MOTOR	20	EXHEXMOD	PATIENT ED MODEL - OSSEOTITE® IMPLANT	48
EHA343	BELLATEK® ENCODE® 2-PC HEALING ABUTMENT, 3.4MM(D) X 3.8MM(P) X 3MM(H)	15	FNT3210	FULL OSSEOTITE TAPERED IMPLANT, 3.25MM(D) X 10MM(L)	7
EHA344	BELLATEK ENCODE 2-PC HEALING ABUTMENT, 3.4MM(D) X 3.8MM(P) X 4MM(H)	15	FNT3211	FULL OSSEOTITE TAPERED IMPLANT, 3.25MM(D) X 11.5MM(L)	7
EHA346	BELLATEK ENCODE 2-PC HEALING ABUTMENT, 3.4MM(D) X 3.8MM(P) X 6MM(H)	15	FNT3213	FULL OSSEOTITE TAPERED IMPLANT, 3.25MM(D) X 13MM(L)	7
EHA348	BELLATEK ENCODE 2-PC HEALING ABUTMENT, 3.4MM(D) X 3.8MM(P) X 8MM(H)	15	FNT3215	FULL OSSEOTITE TAPERED IMPLANT, 3.25MM(D) X 15MM(L)	7
EHA353	BELLATEK ENCODE 2-PC HEALING ABUTMENT, 3.4MM(P) X 5MM(P) X 3MM(H)	15	FNT3285	FULL OSSEOTITE TAPERED IMPLANT, 3.25MM(D) X 8.5MM(L)	7
EHA354	BELLATEK ENCODE 2-PC HEALING ABUTMENT, 3.4MM(P) X 5MM(P) X 4MM(H)	15	FNT410	FULL OSSEOTITE TAPERED IMPLANT, 4MM(D) X 10MM(L)	7
EHA356	BELLATEK ENCODE 2-PC HEALING ABUTMENT, 3.4MM(P) X 5MM(P) X 6MM(H)	15	FNT411	FULL OSSEOTITE TAPERED IMPLANT, 4MM(D) X 11.5MM(L)	7
EHA358	BELLATEK ENCODE 2-PC HEALING ABUTMENT, 3.4MM(P) X 5MM(P) X 8MM(H)	15	FNT413	FULL OSSEOTITE TAPERED IMPLANT, 4MM(D) X 13MM(L)	7
EHA443	BELLATEK ENCODE 2-PC HEALING ABUTMENT, 4.1MM(D) X 4.1MM(P) X 3MM(H)	15	FNT415	FULL OSSEOTITE TAPERED IMPLANT, 4MM(D) X 15MM(L)	7
EHA444	BELLATEK ENCODE 2-PC HEALING ABUTMENT, 4.1MM(D) X 4.1MM(P) X 4MM(H)	15	FNT485	FULL OSSEOTITE TAPERED IMPLANT, 4MM(D) X 8.5MM(L)	7
EHA446	BELLATEK ENCODE 2-PC HEALING ABUTMENT, 4.1MM(D) X 4.1MM(P) X 6MM(H)	15	FNT510	FULL OSSEOTITE TAPERED IMPLANT, 5MM(D) X 10MM(L)	7
EHA448	BELLATEK ENCODE 2-PC HEALING ABUTMENT, 4.1MM(D) X 4.1MM(P) X 8MM(H)	15	FNT511	FULL OSSEOTITE TAPERED IMPLANT, 5MM(D) X 11.5MM(L)	7
EHA453	BELLATEK ENCODE 2-PC HEALING ABUTMENT, 4.1MM(D) X 5MM(P) X 3MM(H)	15	FNT513	FULL OSSEOTITE TAPERED IMPLANT, 5MM(D) X 13MM(L)	7
EHA454	BELLATEK ENCODE 2-PC HEALING ABUTMENT, 4.1MM(D) X 5MM(P) X 4MM(H)	15	FNT515	FULL OSSEOTITE TAPERED IMPLANT, 5MM(D) X 15MM(L)	7
EHA456	BELLATEK ENCODE 2-PC HEALING ABUTMENT, 4.1MM(D) X 5MM(P) X 6MM(H)	15	FNT585	FULL OSSEOTITE TAPERED IMPLANT, 5MM(D) X 8.5MM(L)	7
EHA458	BELLATEK ENCODE 2-PC HEALING ABUTMENT, 4.1MM(D) X 5MM(P) X 8MM(H)	15	FNT610	FULL OSSEOTITE TAPERED IMPLANT, 6MM(D) X 10MM(L)	7
EHA463	BELLATEK ENCODE 2-PC HEALING ABUTMENT, 4.1MM(D) X 6MM(P) X 3MM(H)	15	FNT611	FULL OSSEOTITE TAPERED IMPLANT, 6MM(D) X 11.5MM(L)	7
EHA464	BELLATEK ENCODE 2-PC HEALING ABUTMENT, 4.1MM(D) X 6MM(P) X 4MM(H)	15	FNT613	FULL OSSEOTITE TAPERED IMPLANT, 6MM(D) X 13MM(L)	7
EHA466	BELLATEK ENCODE 2-PC HEALING ABUTMENT, 4.1MM(D) X 6MM(P) X 6MM(H)	15	FNT615	FULL OSSEOTITE TAPERED IMPLANT, 6MM(D) X 15MM(L)	7
EHA468	BELLATEK ENCODE 2-PC HEALING ABUTMENT, 4.1MM(D) X 6MM(P) X 8MM(H)	15	FNT685	FULL OSSEOTITE TAPERED IMPLANT, 6MM(D) X 8.5MM(L)	7
EHA553	BELLATEK ENCODE 2-PC HEALING ABUTMENT, 5MM(D) X 5MM(P) X 3MM(H)	15	FOS307	FULL OSSEOTITE PARALLEL WALLED IMPLANT, 3.75MM(D) X 7MM(L)	10
EHA554	BELLATEK ENCODE 2-PC HEALING ABUTMENT, 5MM(D) X 5MM(P) X 4MM(H)	15	FOS310	FULL OSSEOTITE PARALLEL WALLED IMPLANT, 3.75MM(D) X 10MM(L)	10
EHA556	BELLATEK ENCODE 2-PC HEALING ABUTMENT, 5MM(D) X 5MM(P) X 6MM(H)	15	FOS311	FULL OSSEOTITE PARALLEL WALLED IMPLANT, 3.75MM(D) X 11.5MM(L)	10
EHA558	BELLATEK ENCODE 2-PC HEALING ABUTMENT, 5MM(D) X 5MM(P) X 8MM(H)	15	FOS313	FULL OSSEOTITE PARALLEL WALLED IMPLANT, 3.75MM(D) X 13MM(L)	10
EHA563	BELLATEK ENCODE 2-PC HEALING ABUTMENT, 5MM(D) X 6MM(P) X 3MM(H)	15	FOS315	FULL OSSEOTITE PARALLEL WALLED IMPLANT, 3.75MM(D) X 15MM(L)	10
EHA564	BELLATEK ENCODE 2-PC HEALING ABUTMENT, 5MM(D) X 6MM(P) X 4MM(H)	15	FOS385	FULL OSSEOTITE PARALLEL WALLED IMPLANT, 3.75MM(D) X 8.5MM(L)	10
			FOS407	FULL OSSEOTITE PARALLEL WALLED IMPLANT, 4MM(D) X 7MM(L)	10
			FOS410	FULL OSSEOTITE PARALLEL WALLED IMPLANT, 4MM(D) X 10MM(L)	10
			FOS411	FULL OSSEOTITE PARALLEL WALLED IMPLANT, 4MM(D) X 11.5MM(L)	10
			FOS413	FULL OSSEOTITE PARALLEL WALLED IMPLANT, 4MM(D) X 13MM(L)	10
			FOS415	FULL OSSEOTITE PARALLEL WALLED IMPLANT, 4MM(D) X 15MM(L)	10
			FOS485	FULL OSSEOTITE PARALLEL WALLED IMPLANT, 4MM(D) X 8.5MM(L)	10
			FOS507	FULL OSSEOTITE PARALLEL WALLED IMPLANT, 5MM(D) X 7MM(L)	10
			FOS510	FULL OSSEOTITE PARALLEL WALLED IMPLANT, 5MM(D) X 10MM(L)	10
			FOS511	FULL OSSEOTITE PARALLEL WALLED IMPLANT, 5MM(D) X 11.5MM(L)	10
			FOS513	FULL OSSEOTITE PARALLEL WALLED IMPLANT, 5MM(D) X 13MM(L)	10
			FOS515	FULL OSSEOTITE PARALLEL WALLED IMPLANT, 5MM(D) X 15MM(L)	10
			FOS585	FULL OSSEOTITE PARALLEL WALLED IMPLANT, 5MM(D) X 8.5MM(L)	10
			FOS607	FULL OSSEOTITE PARALLEL WALLED IMPLANT, 6MM(D) X 7MM(L)	10
			FOS610	FULL OSSEOTITE PARALLEL WALLED IMPLANT, 6MM(D) X 10MM(L)	10
			FOS611	FULL OSSEOTITE PARALLEL WALLED IMPLANT, 6MM(D) X 11.5MM(L)	10
			FOS613	FULL OSSEOTITE PARALLEL WALLED IMPLANT, 6MM(D) X 13MM(L)	10
			FOS615	FULL OSSEOTITE PARALLEL WALLED IMPLANT, 6MM(D) X 15MM(L)	10
			FOS685	FULL OSSEOTITE PARALLEL WALLED IMPLANT, 6MM(D) X 8.5MM(L)	10

Index

Item#	Description	Page#	Item#	Description	Page#
FOSM307	FULL OSSEOTITE® PARALLEL WALLED IMPLANT, 3.25MM(D) X 7MM(L)	10	IEHA468	CERTAIN BELLATEK ENCODE 2-PC HEALING ABUTMENT, 4.1MM(D) X 6MM(P) X 8MM(H)	12
FOSM310	FULL OSSEOTITE PARALLEL WALLED IMPLANT, 3.25MM(D) X 10MM(L)	10	IEHA553	CERTAIN BELLATEK ENCODE 2-PC HEALING ABUTMENT, 5MM(D) X 5MM(P) X 3MM(H)	12
FOSM311	FULL OSSEOTITE PARALLEL WALLED IMPLANT, 3.25MM(D) X 11.5MM(L)	10	IEHA554	CERTAIN BELLATEK ENCODE 2-PC HEALING ABUTMENT, 5MM(D) X 5MM(P) X 4MM(H)	12
FOSM313	FULL OSSEOTITE PARALLEL WALLED IMPLANT, 3.25MM(D) X 13MM(L)	10	IEHA556	CERTAIN BELLATEK ENCODE 2-PC HEALING ABUTMENT, 5MM(D) X 5MM(P) X 6MM(H)	12
FOSM315	FULL OSSEOTITE PARALLEL WALLED IMPLANT, 3.25MM(D) X 15MM(L)	10	IEHA558	CERTAIN BELLATEK ENCODE 2-PC HEALING ABUTMENT, 5MM(D) X 5MM(P) X 8MM(H)	12
FOSM385	FULL OSSEOTITE PARALLEL WALLED IMPLANT, 3.25MM(D) X 8.5MM(L)	10	IEHA563	CERTAIN BELLATEK ENCODE 2-PC HEALING ABUTMENT, 5MM(D) X 6MM(P) X 3MM(H)	12
H-TIRW	HIGH TORQUE INDICATING RATCHET WRENCH	39	IEHA564	CERTAIN BELLATEK ENCODE 2-PC HEALING ABUTMENT, 5MM(D) X 6MM(P) X 4MM(H)	12
IBPGP	CERTAIN® PROFILER GUIDE PIN (3-PACK), 4.1, 5 & 6MM(D)	36	IEHA566	CERTAIN BELLATEK ENCODE 2-PC HEALING ABUTMENT, 5MM(D) X 6MM(P) X 6MM(H)	12
IBPMGP	CERTAIN BONE PROFILER GUIDE PIN (3-PACK), 3.25MM(D)	36	IEHA568	CERTAIN BELLATEK ENCODE 2-PC HEALING ABUTMENT, 5MM(D) X 6MM(P) X 8MM(H)	12
IC015	IMPLANT MOUNT, 15MM(L)	39	IEHA663	CERTAIN BELLATEK ENCODE 2-PC HEALING ABUTMENT, 6MM(D) X 6MM(P) X 3MM(H)	12
IC100	SURGICAL INDEX COPING	40	IEHA664	CERTAIN BELLATEK ENCODE 2-PC HEALING ABUTMENT, 6MM(D) X 6MM(P) X 4MM(H)	12
ICD100	CERTAIN COUNTERSINK DRILL, 4MM(D)	32,35	IEHA666	CERTAIN BELLATEK ENCODE 2-PC HEALING ABUTMENT, 6MM(D) X 6MM(P) X 6MM(H)	12
ICD1100	COUNTERSINK DEPTH INDICATOR FOR ICD100	32	IEHA668	CERTAIN BELLATEK ENCODE 2-PC HEALING ABUTMENT, 6MM(D) X 6MM(P) X 8MM(H)	12
ICS375	CERTAIN IMPLANT COVER SCREW, 4.1MM(D) X 1MM(H)	1,2,3,4,5,6	IIPDTL	CERTAIN IMPLANT PLACEMENT DRIVER (LONG), 4.1, 5, 6MM(D)	30,32,40
ICS500	CERTAIN IMPLANT COVER SCREW, 5MM(D) X 1MM(H)	1,2,3,4,5,6	IIPDTS	CERTAIN IMPLANT PLACEMENT DRIVER (SHORT), 4.1, 5, 6MM(D)	30,32,40
ICS600	CERTAIN IMPLANT COVER SCREW, 6MM(D) X 1MM(H)	1,2,3,5,6	ILPCMBP3	CERTAIN LOW PROFILE ABUTMENT MANUAL BONE PROFILER, 3.4MM(D)	36
ICSF41	CERTAIN FLAT IMPLANT COVER SCREW, 4.1MM(D)	1,2,3,4,5,6	ILPCMBP4	CERTAIN LOW PROFILE ABUTMENT MANUAL BONE PROFILER, 4.1MM(D)	36
ICSF50	CERTAIN FLAT IMPLANT COVER SCREW, 5MM(D)	1,2,3,4,5,6	ILPCMBP5	CERTAIN LOW PROFILE ABUTMENT MANUAL BONE PROFILER, 5MM(D)	36
ICSF60	CERTAIN FLAT IMPLANT COVER SCREW, 6MM(D)	1,2	IMBP4	CERTAIN MANUAL BONE PROFILER, 4.1MM(D) X 5MM(P)	22,26,36
IDI001	CERTAIN DIRECTION INDICATOR, 10MM(L)	38	IMBP5	CERTAIN MANUAL BONE PROFILER, 5MM(D) X 6MM(P)	22,26,36
IDIKT	CERTAIN DIRECTION INDICATOR KIT	38	IMCSF34	CERTAIN FLAT IMPLANT COVER SCREW, 3.4MM(D)	1,2,3,4,5,6
IDIM01	CERTAIN DIRECTION INDICATOR, 3.25MM(D) X 10MM(L)	38	IMHA32	CERTAIN EP® 1-PC HEALING ABUTMENT, 3.4MM(D) X 3.8MM(P) X 2MM(H)	13
IEHA343	CERTAIN BELLATEK® ENCODE® 2-PC HEALING ABUTMENT, 3.4MM(D) X 3.8MM(P) X 3MM(H)	12	IMHA33	CERTAIN EP 1-PC HEALING ABUTMENT, 3.4MM(D) X 3.8MM(P) X 3MM(H)	13
IEHA344	CERTAIN BELLATEK ENCODE 2-PC HEALING ABUTMENT, 3.4MM(D) X 3.8MM(P) X 4MM(H)	12	IMHA34	CERTAIN EP 1-PC HEALING ABUTMENT, 3.4MM(D) X 3.8MM(P) X 4MM(H)	13
IEHA346	CERTAIN BELLATEK ENCODE 2-PC HEALING ABUTMENT, 3.4MM(D) X 3.8MM(P) X 6MM(H)	12	IMHA36	CERTAIN EP 1-PC HEALING ABUTMENT, 3.4MM(D) X 3.8MM(P) X 6MM(H)	13
IEHA348	CERTAIN BELLATEK ENCODE 2-PC HEALING ABUTMENT, 3.4MM(D) X 3.8MM(P) X 8MM(H)	12	IMHA352	CERTAIN EP 1-PC HEALING ABUTMENT, 3.4MM(D) X 5MM(P) X 2MM(H)	13
IEHA353	CERTAIN BELLATEK ENCODE 2-PC HEALING ABUTMENT, 3.4MM(D) X 5MM(P) X 3MM(H)	12	IMHA353	CERTAIN EP 1-PC HEALING ABUTMENT, 3.4MM(D) X 5MM(P) X 3MM(H)	13
IEHA354	CERTAIN BELLATEK ENCODE 2-PC HEALING ABUTMENT, 3.4MM(D) X 5MM(P) X 4MM(H)	12	IMHA354	CERTAIN EP 1-PC HEALING ABUTMENT, 3.4MM(D) X 5MM(P) X 4MM(H)	13
IEHA356	CERTAIN BELLATEK ENCODE 2-PC HEALING ABUTMENT, 3.4MM(D) X 5MM(P) X 6MM(H)	12	IMHA356	CERTAIN EP 1-PC HEALING ABUTMENT, 3.4MM(D) X 5MM(P) X 6MM(H)	13
IEHA358	CERTAIN BELLATEK ENCODE 2-PC HEALING ABUTMENT, 3.4MM(D) X 5MM(P) X 8MM(H)	12	IMMBP	CERTAIN MANUAL BONE PROFILER, 3.4MM(D) X 4.1MM(P)	22,26,36
IEHA443	CERTAIN BELLATEK ENCODE 2-PC HEALING ABUTMENT, 4.1MM(D) X 4.1MM(P) X 3MM(H)	12	IMMBP35	CERTAIN MANUAL BONE PROFILER, 3.4MM(D) X 5MM(P)	36
IEHA444	CERTAIN BELLATEK ENCODE 2-PC HEALING ABUTMENT, 4.1MM(D) X 4.1MM(P) X 4MM(H)	12	IMMCS1	CERTAIN COVER SCREW, 3.4MM(D) X 1MM(H)	1,2,3,4,5,6
IEHA446	CERTAIN BELLATEK ENCODE 2-PC HEALING ABUTMENT, 4.1MM(D) X 4.1MM(P) X 6MM(H)	12	IMPDTL	CERTAIN IMPLANT PLACEMENT DRIVER TIP, 3.4MM(D) LONG	30,32,40
IEHA448	CERTAIN BELLATEK ENCODE 2-PC HEALING ABUTMENT, 4.1MM(D) X 4.1MM(P) X 8MM(H)	12	IMPDTS	CERTAIN IMPLANT PLACEMENT DRIVER TIP, 3.4MM(D) SHORT	30,32,40
IEHA453	BELLATEK CERTAIN ENCODE 2-PC HEALING ABUTMENT, 4.1MM(D) X 5MM(P) X 3MM(H)	12	IRE100U	CERTAIN UNIVERSAL RATCHET EXTENSION, 6MM(L) SHORT	30,32,39
IEHA454	CERTAIN BELLATEK ENCODE 2-PC HEALING ABUTMENT, 4.1MM(D) X 5MM(P) X 4MM(H)	12	IRE200U	CERTAIN UNIVERSAL RATCHET EXTENSION, 15MM(L) LONG	30,32,39
IEHA456	CERTAIN BELLATEK ENCODE 2-PC HEALING ABUTMENT, 4.1MM(D) X 5MM(P) X 6MM(H)	12	IRORDR	CERTAIN DRIVER REPLACEMENT O-RINGS, QTY:10	30,32,40
IEHA458	CERTAIN BELLATEK ENCODE 2-PC HEALING ABUTMENT, 4.1MM(D) X 5MM(P) X 8MM(H)	12	ISHA42	CERTAIN EP 1-PC HEALING ABUTMENT, 4.1MM(D) X 4.1MM(P) X 2MM(H)	13
IEHA463	CERTAIN BELLATEK ENCODE 2-PC HEALING ABUTMENT, 4.1MM(D) X 6MM(P) X 3MM(H)	12	ISHA43	CERTAIN EP 1-PC HEALING ABUTMENT, 4.1MM(D) X 4.1MM(P) X 3MM(H)	13
IEHA464	CERTAIN BELLATEK ENCODE 2-PC HEALING ABUTMENT, 4.1MM(D) X 6MM(P) X 4MM(H)	12	ISHA44	CERTAIN EP 1-PC HEALING ABUTMENT, 4.1MM(D) X 4.1MM(P) X 4MM(H)	13
IEHA466	CERTAIN BELLATEK ENCODE 2-PC HEALING ABUTMENT, 4.1MM(D) X 6MM(P) X 6MM(H)	12	ISHA46	CERTAIN EP 1-PC HEALING ABUTMENT, 4.1MM(D) X 4.1MM(P) X 6MM(H)	13
			ISHA48	CERTAIN EP 1-PC HEALING ABUTMENT, 4.1MM(D) X 4.1MM(P) X 8MM(H)	13
			ISMHA32	CERTAIN EP 1-PC HEALING ABUTMENT, 3.4MM(D) X 3.4MM(P) X 2MM(H)	13
			ISMHA33	CERTAIN EP 1-PC HEALING ABUTMENT, 3.4MM(D) X 3.4MM(P) X 3MM(H)	13
			ISMHA34	CERTAIN EP 1-PC HEALING ABUTMENT, 3.4MM(D) X 3.4MM(P) X 4MM(H)	13
			ISMHA36	CERTAIN EP 1-PC HEALING ABUTMENT, 3.4MM(D) X 3.4MM(P) X 6MM(H)	13

Item#	Description	Page#	Item#	Description	Page#
ISWHA52	CERTAIN® EP® 1-PC HEALING ABUTMENT, 5MM(D) X 5MM(P) X 2MM(H)	14	MSGIIML	NAVIGATOR CERTAIN IMPLANT MOUNT, 3.4MM(D) - LONG	22
ISWHA53	CERTAIN EP 1-PC HEALING ABUTMENT, 5MM(D) X 5MM(P) X 3MM(H)	14	MSGIIMS	NAVIGATOR CERTAIN IMPLANT MOUNT, 3.4MM(D) - SHORT	22
ISWHA54	CERTAIN EP 1-PC HEALING ABUTMENT, 5MM(D) X 5MM(P) X 4MM(H)	14	MSGIIM1	NAVIGATOR CERTAIN IMPLANT MOUNT, 3.4MM(D) X 1(L)	26
ISWHA56	CERTAIN EP 1-PC HEALING ABUTMENT, 5MM(D) X 5MM(P) X 6MM(H)	14	MSGIIM2	NAVIGATOR CERTAIN IMPLANT MOUNT, 3.4MM(D) X 2(L)	26
ISWHA58	CERTAIN EP 1-PC HEALING ABUTMENT, 5MM(D) X 5MM(P) X 8MM(H)	14	MSGIIM3	NAVIGATOR CERTAIN IMPLANT MOUNT, 3.4MM(D) X 3(L)	26
ISWHA62	CERTAIN EP 1-PC HEALING ABUTMENT, 6MM(D) X 6MM(P) X 2MM(H)	14	MSGIIM4	NAVIGATOR CERTAIN IMPLANT MOUNT, 3.4MM(D) X 4(L)	26
ISWHA63	CERTAIN EP 1-PC HEALING ABUTMENT, 6MM(D) X 6MM(P) X 3MM(H)	14	MSGSD	NAVIGATOR STARTER DRILL, 3.4MM(D)	25
ISWHA64	CERTAIN EP 1-PC HEALING ABUTMENT, 6MM(D) X 6MM(P) X 4MM(H)	14	MSGTAP	NAVIGATOR BONE TAP, 3.25MM(D)	26
ISWHA66	CERTAIN EP 1-PC HEALING ABUTMENT, 6MM(D) X 6MM(P) X 6MM(H)	14	MSGTCDL	TAPERED NAVIGATOR COUNTERSINK DRILL, 3.4MM(D) - LONG	21
ISWHA68	CERTAIN EP 1-PC HEALING ABUTMENT, 6MM(D) X 6MM(P) X 8MM(H)	14	MSGTCDS	TAPERED NAVIGATOR COUNTERSINK DRILL, 3.4MM(D) - SHORT	21
ITHA52	CERTAIN EP 1-PC HEALING ABUTMENT, 4.1MM(D) X 5MM(P) X 2MM(H)	13	MSGTD10L	TAPERED NAVIGATOR SHAPING DRILL, 3.25MM(D) X 10MM(L) - LONG	22
ITHA53	CERTAIN EP 1-PC HEALING ABUTMENT, 4.1MM(D) X 5MM(P) X 3MM(H)	13	MSGTD10S	TAPERED NAVIGATOR SHAPING DRILL, 3.25MM(D) X 10MM(L) - SHORT	21
ITHA54	CERTAIN EP 1-PC HEALING ABUTMENT, 4.1MM(D) X 5MM(P) X 4MM(H)	13	MSGTD11L	TAPERED NAVIGATOR SHAPING DRILL, 3.25MM(D) X 11.5MM(L) - LONG	22
ITHA56	CERTAIN EP 1-PC HEALING ABUTMENT, 4.1MM(D) X 5MM(P) X 6MM(H)	13	MSGTD11S	TAPERED NAVIGATOR SHAPING DRILL, 3.25MM(D) X 11.5MM(L) - SHORT	21
ITHA58	CERTAIN EP 1-PC HEALING ABUTMENT, 4.1MM(D) X 5MM(P) X 8MM(H)	13	MSGTD13L	TAPERED NAVIGATOR SHAPING DRILL, 3.25MM(D) X 13MM(L) - LONG	22
ITHA63	CERTAIN EP 1-PC HEALING ABUTMENT, 4.1MM(D) X 6MM(P) X 3MM(H)	13	MSGTD13S	TAPERED NAVIGATOR SHAPING DRILL, 3.25MM(D) X 13MM(L) - SHORT	21
ITHA64	CERTAIN EP 1-PC HEALING ABUTMENT, 4.1MM(D) X 6MM(P) X 4MM(H)	13	MSGTD15L	TAPERED NAVIGATOR SHAPING DRILL, 3.25MM(D) X 15MM(L) - LONG	22
ITHA66	CERTAIN EP 1-PC HEALING ABUTMENT, 4.1MM(D) X 6MM(P) X 6MM(H)	13	MSGTD15S	TAPERED NAVIGATOR SHAPING DRILL, 3.25MM(D) X 15MM(L) - SHORT	21
ITHA68	CERTAIN EP 1-PC HEALING ABUTMENT, 4.1MM(D) X 6MM(P) X 8MM(H)	13	MSGTD85L	TAPERED NAVIGATOR SHAPING DRILL, 3.25MM(D) X 8.5MM(L) - LONG	22
IWTH52	CERTAIN EP 1-PC HEALING ABUTMENT, 5MM(D) X 5MM(P) X 2MM(H)	14	MSGTD85S	TAPERED NAVIGATOR SHAPING DRILL, 3.25MM(D) X 8.5MM(L) - SHORT	21
IWTH53	CERTAIN EP 1-PC HEALING ABUTMENT, 5MM(D) X 5MM(P) X 3MM(H)	14	MSGTT10L	TAPERED NAVIGATOR BONE TAP, 3.25MM(D) X 10(L) - LONG	23
IWTH54	CERTAIN EP 1-PC HEALING ABUTMENT, 5MM(D) X 5MM(P) X 4MM(H)	14	MSGTT10S	TAPERED NAVIGATOR BONE TAP, 3.25MM(D) X 10(L) - SHORT	23
IWTH56	CERTAIN EP 1-PC HEALING ABUTMENT, 5MM(D) X 5MM(P) X 6MM(H)	14	MSGTT11L	TAPERED NAVIGATOR BONE TAP, 3.25MM(D) X 11.5(L) - LONG	23
IWTH562	CERTAIN EP 1-PC HEALING ABUTMENT, 5MM(D) X 6MM(P) X 2MM(H)	14	MSGTT11S	TAPERED NAVIGATOR BONE TAP, 3.25MM(D) X 11.5(L) - SHORT	23
IWTH563	CERTAIN EP 1-PC HEALING ABUTMENT, 5MM(D) X 6MM(P) X 3MM(H)	14	MSGTT13L	TAPERED NAVIGATOR BONE TAP, 3.25MM(D) X 13(L) - LONG	23
IWTH564	CERTAIN EP 1-PC HEALING ABUTMENT, 5MM(D) X 6MM(P) X 4MM(H)	14	MSGTT13S	TAPERED NAVIGATOR BONE TAP, 3.25MM(D) X 13(L) - SHORT	23
IWTH566	CERTAIN EP 1-PC HEALING ABUTMENT, 5MM(D) X 6MM(P) X 6MM(H)	14	MSGTT15L	TAPERED NAVIGATOR BONE TAP, 3.25MM(D) X 15(L) - LONG	23
IWTH568	CERTAIN EP 1-PC HEALING ABUTMENT, 5MM(D) X 6MM(P) X 8MM(H)	14	MSGTT15S	TAPERED NAVIGATOR BONE TAP, 3.25MM(D) X 15(L) - SHORT	23
IWTH58	CERTAIN EP 1-PC HEALING ABUTMENT, 5MM(D) X 5MM(P) X 8MM(H)	14	MSGTT85L	TAPERED NAVIGATOR BONE TAP, 3.25MM(D) X 8.5(L) - LONG	23
IWTH62	CERTAIN EP 1-PC HEALING ABUTMENT, 6MM(D) X 6MM(P) X 2MM(H)	14	MSGTT85S	TAPERED NAVIGATOR BONE TAP, 3.25MM(D) X 8.5(L) - SHORT	23
IWTH63	CERTAIN EP 1-PC HEALING ABUTMENT, 6MM(D) X 6MM(P) X 3MM(H)	14	MTAP1	DENSE BONE TAP FOR PARALLEL WALLED IMPLANTS, 3.25MM(D) - SHORT	37
IWTH64	CERTAIN EP 1-PC HEALING ABUTMENT, 6MM(D) X 6MM(P) X 4MM(H)	14	MTAP2	DENSE BONE TAP FOR PARALLEL WALLED IMPLANTS, 3.25MM(D) - LONG	32,33,37
IWTH66	CERTAIN EP 1-PC HEALING ABUTMENT, 6MM(D) X 6MM(P) X 6MM(H)	14	NIITP4310	NANOTITE™ TAPERED CERTAIN PREVAIL® IMPLANT, 4MM(D) X 3MM(P) X 10MM(L)	3
IWTH68	CERTAIN EP 1-PC HEALING ABUTMENT, 6MM(D) X 6MM(P) X 8MM(H)	14	NIITP4311	NANOTITE TAPERED CERTAIN PREVAIL IMPLANT, 4MM(D) X 3MM(P) X 11.5MM(L)	3
LPCBP3	LOW PROFILE ABUTMENT BONE PROFILER, 3.4MM(D)	36	NIITP4313	NANOTITE TAPERED CERTAIN PREVAIL IMPLANT, 4MM(D) X 3MM(P) X 13MM(L)	3
LPCBP4	LOW PROFILE ABUTMENT BONE PROFILER, 4.1MM(D)	36	NIITP4315	NANOTITE TAPERED CERTAIN PREVAIL IMPLANT, 4MM(D) X 3MM(P) X 15MM(L)	3
LPCBP5	LOW PROFILE ABUTMENT BONE PROFILER, 5MM(D)	36	NIITP4385	NANOTITE TAPERED CERTAIN PREVAIL IMPLANT, 4MM(D) X 3MM(P) X 8.5MM(L)	3
MALL1	MALLET, STAINLESS STEEL	39	NIITP5410	NANOTITE TAPERED CERTAIN PREVAIL IMPLANT, 5MM(D) X 4MM(P) X 10MM(L)	3
MDR10	HANDPIECE CONNECTOR	22,26,30,32,34,40	NIITP5411	NANOTITE TAPERED CERTAIN PREVAIL IMPLANT, 5MM(D) X 4MM(P) X 11.5MM(L)	3
ME100	SMALL MEMBRANE ELEVATOR	42	NIITP5413	NANOTITE TAPERED CERTAIN PREVAIL IMPLANT, 5MM(D) X 4MM(P) X 13MM(L)	3
ME200	MEDIUM MEMBRANE ELEVATOR	42	NIITP5415	NANOTITE TAPERED CERTAIN PREVAIL IMPLANT, 5MM(D) X 4MM(P) X 15MM(L)	3
ME300	LARGE MEMBRANE ELEVATOR	42			
MHA32	EP 1-PIECE HEALING ABUTMENT, 3.4MM(D) X 3.8MM(P) X 2MM(H)	16			
MHA33	EP 1-PIECE HEALING ABUTMENT, 3.4MM(D) X 3.8MM(P) X 3MM(H)	16			
MHA34	EP 1-PIECE HEALING ABUTMENT, 3.4MM(D) X 3.8MM(P) X 4MM(H)	16			
MHA36	EP 1-PIECE HEALING ABUTMENT, 3.4MM(D) X 3.8MM(P) X 6MM(H)	16			
MIDTH	MANUAL INTERCHANGEABLE DRIVER TIP HANDLE	39			
MMC03	IMPLANT MOUNT, 3.4MM(D) X 3MM(L)	38			
MMC15	IMPLANT MOUNT, 3.4MM(D) X 15MM(L)	30,32,34,38			
MMCS1	IMPLANT COVER SCREW, 3.4MM(D) X 1MM(H)	7,8,9,10			
MMKIT	IMPLANT MOUNT KIT, 3.4MM(D)	38			
MSGIAM1	NAVIGATOR® CERTAIN ANALOG MOUNT, 3.4MM(D) X 1(L)	27			
MSGIAM2	NAVIGATOR CERTAIN ANALOG MOUNT, 3.4MM(D) X 2(L)	27			
MSGIAM3	NAVIGATOR CERTAIN ANALOG MOUNT, 3.4MM(D) X 3(L)	27			
MSGIAM4	NAVIGATOR CERTAIN ANALOG MOUNT, 3.4MM(D) X 4(L)	27			
MSGIAML	NAVIGATOR CERTAIN ANALOG MOUNT, 3.4MM(D) - LONG	24			
MSGIAMS	NAVIGATOR CERTAIN ANALOG MOUNT, 3.4MM(D) - SHORT	24			

Index

Item#	Description	Page#	Item#	Description	Page#
NIITP5485	NANOTITE™ TAPERED CERTAIN® PREVAIL® IMPLANT, 5MM(D) X 4MM(P) X 8.5MM(L)	3	NIOSM318	NANOTITE PARALLEL WALLED CERTAIN IMPLANT, 3.25MM(D) X 18MM(L)	5
NIITP6510	NANOTITE TAPERED CERTAIN PREVAIL IMPLANT, 6MM(D) X 5MM(P) X 10MM(L)	3	NIOSM385	NANOTITE PARALLEL WALLED CERTAIN IMPLANT, 3.25MM(D) X 8.5MM(L)	5
NIITP6511	NANOTITE TAPERED CERTAIN PREVAIL IMPLANT, 6MM(D) X 5MM(P) X 11.5MM(L)	3	NIOSS410	NANOTITE PARALLEL WALLED CERTAIN IMPLANT, 4MM(D) X 10MM(L)	5
NIITP6513	NANOTITE TAPERED CERTAIN PREVAIL IMPLANT, 6MM(D) X 5MM(P) X 13MM(L)	3	NIOSS411	NANOTITE PARALLEL WALLED CERTAIN IMPLANT, 4MM(D) X 11.5MM(L)	5
NIITP6515	NANOTITE TAPERED CERTAIN PREVAIL IMPLANT, 6MM(D) X 5MM(P) X 15MM(L)	3	NIOSS413	NANOTITE PARALLEL WALLED CERTAIN IMPLANT, 4MM(D) X 13MM(L)	5
NIITP6585	NANOTITE TAPERED CERTAIN PREVAIL IMPLANT, 6MM(D) X 5MM(P) X 8.5MM(L)	3	NIOSS415	NANOTITE PARALLEL WALLED CERTAIN IMPLANT, 4MM(D) X 15MM(L)	5
NINT3210	NANOTITE TAPERED CERTAIN IMPLANT, 3.25MM(D) X 10MM(L)	3	NIOSS418	NANOTITE PARALLEL WALLED CERTAIN IMPLANT, 4MM(D) X 18MM(L)	5
NINT3211	NANOTITE TAPERED CERTAIN IMPLANT, 3.25MM(D) X 11.5MM(L)	3	NIOSS485	NANOTITE PARALLEL WALLED CERTAIN IMPLANT, 4MM(D) X 8.5MM(L)	5
NINT3213	NANOTITE TAPERED CERTAIN IMPLANT, 3.25MM(D) X 13MM(L)	3	NIOSS510	NANOTITE PARALLEL WALLED CERTAIN IMPLANT, 5MM(D) X 10MM(L)	5
NINT3215	NANOTITE TAPERED CERTAIN IMPLANT, 3.25MM(D) X 15MM(L)	3	NIOSS511	NANOTITE PARALLEL WALLED CERTAIN IMPLANT, 5MM(D) X 11.5MM(L)	5
NINT3285	NANOTITE TAPERED CERTAIN IMPLANT, 3.25MM(D) X 8.5MM(L)	3	NIOSS513	NANOTITE PARALLEL WALLED CERTAIN IMPLANT, 5MM(D) X 13MM(L)	5
NINT410	NANOTITE TAPERED CERTAIN IMPLANT, 4MM(D) X 10MM(L)	3	NIOSS515	NANOTITE PARALLEL WALLED CERTAIN IMPLANT, 5MM(D) X 15MM(L)	5
NINT411	NANOTITE TAPERED CERTAIN IMPLANT, 4MM(D) X 11.5MM(L)	3	NIOSS585	NANOTITE PARALLEL WALLED CERTAIN IMPLANT, 5MM(D) X 8.5MM(L)	5
NINT413	NANOTITE TAPERED CERTAIN IMPLANT, 4MM(D) X 13MM(L)	3	NIOSS610	NANOTITE PARALLEL WALLED CERTAIN IMPLANT, 6MM(D) X 10MM(L)	5
NINT415	NANOTITE TAPERED CERTAIN IMPLANT, 4MM(D) X 15MM(L)	3	NIOSS611	NANOTITE PARALLEL WALLED CERTAIN IMPLANT, 6MM(D) X 11.5MM(L)	5
NINT485	NANOTITE TAPERED CERTAIN IMPLANT, 4MM(D) X 8.5MM(L)	3	NIOSS613	NANOTITE PARALLEL WALLED CERTAIN IMPLANT, 6MM(D) X 13MM(L)	5
NINT510	NANOTITE TAPERED CERTAIN IMPLANT, 5MM(D) X 10MM(L)	3	NIOSS615	NANOTITE PARALLEL WALLED CERTAIN IMPLANT, 6MM(D) X 15MM(L)	5
NINT511	NANOTITE TAPERED CERTAIN IMPLANT, 5MM(D) X 11.5MM(L)	3	NNT3210	NANOTITE TAPERED IMPLANT, 3.25MM(D) X 10MM(L)	7
NINT513	NANOTITE TAPERED CERTAIN IMPLANT, 5MM(D) X 13MM(L)	3	NNT3211	NANOTITE TAPERED IMPLANT, 3.25MM(D) X 11.5MM(L)	7
NINT515	NANOTITE TAPERED CERTAIN IMPLANT, 5MM(D) X 15MM(L)	3	NNT3213	NANOTITE TAPERED IMPLANT, 3.25MM(D) X 13MM(L)	7
NINT585	NANOTITE TAPERED CERTAIN IMPLANT, 5MM(D) X 8.5MM(L)	3	NNT3215	NANOTITE TAPERED IMPLANT, 3.25MM(D) X 15MM(L)	7
NINT610	NANOTITE TAPERED CERTAIN IMPLANT, 6MM(D) X 10MM(L)	3	NNT3285	NANOTITE TAPERED IMPLANT, 3.25MM(D) X 8.5MM(L)	7
NINT611	NANOTITE TAPERED CERTAIN IMPLANT, 6MM(D) X 11.5MM(L)	3	NNT410	NANOTITE TAPERED IMPLANT, 4MM(D) X 10MM(L)	7
NINT613	NANOTITE TAPERED CERTAIN IMPLANT, 6MM(D) X 13MM(L)	3	NNT411	NANOTITE TAPERED IMPLANT, 4MM(D) X 11.5MM(L)	7
NINT615	NANOTITE TAPERED CERTAIN IMPLANT, 6MM(D) X 15MM(L)	3	NNT413	NANOTITE TAPERED IMPLANT, 4MM(D) X 13MM(L)	7
NINT685	NANOTITE TAPERED CERTAIN IMPLANT, 6MM(D) X 8.5MM(L)	3	NNT415	NANOTITE TAPERED IMPLANT, 4MM(D) X 15MM(L)	7
NIIOS4310	NANOTITE CERTAIN PREVAIL IMPLANT, 4MM(D) X 3.4MM(C) X 10MM(L)	4	NNT485	NANOTITE TAPERED IMPLANT, 4MM(D) X 8.5MM(L)	7
NIIOS4311	NANOTITE CERTAIN PREVAIL IMPLANT, 4MM(D) X 3.4MM(C) X 11.5MM(L)	4	NNT510	NANOTITE TAPERED IMPLANT, 5MM(D) X 10MM(L)	7
NIIOS4313	NANOTITE CERTAIN PREVAIL IMPLANT, 4MM(D) X 3.4MM(C) X 13MM(L)	4	NNT511	NANOTITE TAPERED IMPLANT, 5MM(D) X 11.5MM(L)	7
NIIOS4315	NANOTITE CERTAIN PREVAIL IMPLANT, 4MM(D) X 3.4MM(C) X 15MM(L)	4	NNT513	NANOTITE TAPERED IMPLANT, 5MM(D) X 13MM(L)	7
NIIOS4385	NANOTITE CERTAIN PREVAIL IMPLANT, 4MM(D) X 3.4MM(C) X 8.5MM(L)	4	NNT515	NANOTITE TAPERED IMPLANT, 5MM(D) X 15MM(L)	7
NIIOS5485	NANOTITE CERTAIN PREVAIL IMPLANT, 5MM(D) X 4.1MM(P) X 8.5MM(L)	4	NNT585	NANOTITE TAPERED IMPLANT, 5MM(D) X 8.5MM(L)	7
NIIOS5410	NANOTITE CERTAIN PREVAIL IMPLANT, 5MM(D) X 4.1MM(P) X 10MM(L)	4	NNT610	NANOTITE TAPERED IMPLANT, 6MM(D) X 10MM(L)	7
NIIOS5411	NANOTITE CERTAIN PREVAIL IMPLANT, 5MM(D) X 4.1MM(P) X 11MM(L)	4	NNT611	NANOTITE TAPERED IMPLANT, 6MM(D) X 11.5MM(L)	7
NIIOS5413	NANOTITE CERTAIN PREVAIL IMPLANT, 5MM(D) X 4.1MM(P) X 13MM(L)	4	NNT613	NANOTITE TAPERED IMPLANT, 6MM(D) X 13MM(L)	7
NIIOS5415	NANOTITE CERTAIN PREVAIL IMPLANT, 5MM(D) X 4.1MM(P) X 15MM(L)	4	NNT615	NANOTITE TAPERED IMPLANT, 6MM(D) X 15MM(L)	7
NIOSM310	NANOTITE PARALLEL WALLED CERTAIN IMPLANT, 3.25MM(D) X 10MM(L)	5	NNT685	NANOTITE TAPERED IMPLANT, 6MM(D) X 8.5MM(L)	7
NIOSM311	NANOTITE PARALLEL WALLED CERTAIN IMPLANT, 3.25MM(D) X 11.5MM(L)	5	NOSM310	NANOTITE PARALLEL WALLED IMPLANT, 3.25MM(D) X 10MM(L)	9
NIOSM313	NANOTITE PARALLEL WALLED CERTAIN IMPLANT, 3.25MM(D) X 13MM(L)	5	NOSM311	NANOTITE PARALLEL WALLED IMPLANT, 3.25MM(D) X 11.5MM(L)	9
NIOSM315	NANOTITE PARALLEL WALLED CERTAIN IMPLANT, 3.25MM(D) X 15MM(L)	5	NOSM313	NANOTITE PARALLEL WALLED IMPLANT, 3.25MM(D) X 13MM(L)	9
NIOSM318	NANOTITE PARALLEL WALLED CERTAIN IMPLANT, 3.25MM(D) X 18MM(L)	5	NOSM315	NANOTITE PARALLEL WALLED IMPLANT, 3.25MM(D) X 15MM(L)	9
NIOSM385	NANOTITE PARALLEL WALLED CERTAIN IMPLANT, 3.25MM(D) X 8.5MM(L)	5	NOSM318	NANOTITE PARALLEL WALLED IMPLANT, 3.25MM(D) X 18MM(L)	9
NOSS407	NANOTITE PARALLEL WALLED IMPLANT, 4MM(D) X 7MM(L)	9	NOSM385	NANOTITE PARALLEL WALLED IMPLANT, 3.25MM(D) X 8.5MM(L)	9
NOSS410	NANOTITE PARALLEL WALLED IMPLANT, 4MM(D) X 10MM(L)	9	NOSS407	NANOTITE PARALLEL WALLED IMPLANT, 4MM(D) X 7MM(L)	9
NOSS411	NANOTITE PARALLEL WALLED IMPLANT, 4MM(D) X 11.5MM(L)	9	NOSS410	NANOTITE PARALLEL WALLED IMPLANT, 4MM(D) X 10MM(L)	9
NOSS413	NANOTITE PARALLEL WALLED IMPLANT, 4MM(D) X 13MM(L)	9	NOSS411	NANOTITE PARALLEL WALLED IMPLANT, 4MM(D) X 11.5MM(L)	9
NOSS415	NANOTITE PARALLEL WALLED IMPLANT, 4MM(D) X 15MM(L)	9	NOSS413	NANOTITE PARALLEL WALLED IMPLANT, 4MM(D) X 13MM(L)	9
			NOSS415	NANOTITE PARALLEL WALLED IMPLANT, 4MM(D) X 15MM(L)	9

Index

Item#	Description	Page#	Item#	Description	Page#
NOSS418	NANOTITE™ PARALLEL WALLED IMPLANT, 4MM(D) X 18MM(L)	9	NTAPKT	DENSE BONE TAP KIT TRAY FOR TAPERED IMPLANTS	29
NOSS485	NANOTITE PARALLEL WALLED IMPLANT, 4MM(D) X 8.5MM(L)	9	NTDI3210	OSSEOTITE TAPERED DEPTH INDICATOR, 3.25MM X 10MM	29,38
NOSS507	NANOTITE PARALLEL WALLED IMPLANT, 5MM(D) X 7MM(L)	9	NTDI3211	OSSEOTITE TAPERED DEPTH INDICATOR, 3.25MM X 11.5MM	29,38
NOSS510	NANOTITE PARALLEL WALLED IMPLANT, 5MM(D) X 10MM(L)	9	NTDI3213	OSSEOTITE TAPERED DEPTH INDICATOR, 3.25MM X 13MM	29,38
NOSS511	NANOTITE PARALLEL WALLED IMPLANT, 5MM(D) X 11.5MM(L)	9	NTDI3215	OSSEOTITE TAPERED DEPTH INDICATOR, 3.25MM X 15MM	29,38
NOSS513	NANOTITE PARALLEL WALLED IMPLANT, 5MM(D) X 13MM(L)	9	NTDI3285	OSSEOTITE TAPERED DEPTH INDICATOR, 3.25MM X 8.5MM	29,38
NOSS515	NANOTITE PARALLEL WALLED IMPLANT, 5MM(D) X 15MM(L)	9	NTDI410	OSSEOTITE TAPERED DEPTH INDICATOR, 4MM X 10MM	29,38
NOSS518	NANOTITE PARALLEL WALLED IMPLANT, 5MM(D) X 18MM(L)	9	NTDI411	OSSEOTITE TAPERED DEPTH INDICATOR, 4MM X 11.5MM	29,38
NOSS585	NANOTITE PARALLEL WALLED IMPLANT, 5MM(D) X 8.5MM(L)	9	NTDI413	OSSEOTITE TAPERED DEPTH INDICATOR, 4MM X 13MM	29,38
NOSS607	NANOTITE PARALLEL WALLED IMPLANT, 6MM(D) X 7MM(L)	9	NTDI415	OSSEOTITE TAPERED DEPTH INDICATOR, 4MM X 15MM	29,38
NOSS610	NANOTITE PARALLEL WALLED IMPLANT, 6MM(D) X 10MM(L)	9	NTDI485	OSSEOTITE TAPERED DEPTH INDICATOR, 4MM X 8.5MM	29,38
NOSS611	NANOTITE PARALLEL WALLED IMPLANT, 6MM(D) X 11.5MM(L)	9	NTDI510	OSSEOTITE TAPERED DEPTH INDICATOR, 5MM X 10MM	29,38
NOSS613	NANOTITE PARALLEL WALLED IMPLANT, 6MM(D) X 13MM(L)	9	NTDI511	OSSEOTITE TAPERED DEPTH INDICATOR, 5MM X 11.5MM	29,38
NOSS615	NANOTITE PARALLEL WALLED IMPLANT, 6MM(D) X 15MM(L)	9	NTDI513	OSSEOTITE TAPERED DEPTH INDICATOR, 5MM X 13MM	29,38
NOSS618	NANOTITE PARALLEL WALLED IMPLANT, 6MM(D) X 18MM(L)	9	NTDI515	OSSEOTITE TAPERED DEPTH INDICATOR, 5MM X 15MM	29,38
NOSS685	NANOTITE PARALLEL WALLED IMPLANT, 6MM(D) X 8.5MM(L)	9	NTDI585	OSSEOTITE TAPERED DEPTH INDICATOR, 5MM X 8.5MM	29,38
NT3210	OSSEOTITE® TAPERED IMPLANT, 3.25MM(D) X 10MM(L)	8	NTDI610	OSSEOTITE TAPERED DEPTH INDICATOR, 6MM X 10MM	29,38
NT3211	OSSEOTITE TAPERED IMPLANT, 3.25MM(D) X 11.5MM(L)	8	NTDI611	OSSEOTITE TAPERED DEPTH INDICATOR, 6MM X 11.5MM	29,38
NT3213	OSSEOTITE TAPERED IMPLANT, 3.25MM(D) X 13MM(L)	8	NTDI613	OSSEOTITE TAPERED DEPTH INDICATOR, 6MM X 13MM	29,38
NT3215	OSSEOTITE TAPERED IMPLANT, 3.25MM(D) X 15MM(L)	8	NTDI615	OSSEOTITE TAPERED DEPTH INDICATOR, 6MM X 15MM	29,38
NT3285	OSSEOTITE TAPERED IMPLANT, 3.25MM(D) X 8.5MM(L)	8	NTDI685	OSSEOTITE TAPERED DEPTH INDICATOR, 6MM X 8.5MM	29,38
NT410	OSSEOTITE TAPERED IMPLANT, 4MM(D) X 10MM(L)	8	NTDIK	OSSEOTITE TAPERED DIRECTION/DEPTH INDICATOR KIT	38
NT411	OSSEOTITE TAPERED IMPLANT, 4MM(D) X 11.5MM(L)	8	NTOST0	OSSEOTITE TAPERED OSTEOTOME SYSTEM KIT, STRAIGHT	41
NT413	OSSEOTITE TAPERED IMPLANT, 4MM(D) X 13MM(L)	8	NTOST0A	OSSEOTITE TAPERED OSTEOTOME SYSTEM KIT, ANGLED	41
NT415	OSSEOTITE TAPERED IMPLANT, 4MM(D) X 15MM(L)	8	NTOST3	OSSEOTITE TAPERED STRAIGHT OSTEOTOME, 3.25MM	41
NT485	OSSEOTITE TAPERED IMPLANT, 4MM(D) X 8.5MM(L)	8	NTOST3A	OSSEOTITE TAPERED ANGLED OSTEOTOME, 3.25MM	41
NT510	OSSEOTITE TAPERED IMPLANT, 5MM(D) X 10MM(L)	8	NTOST4	OSSEOTITE TAPERED STRAIGHT OSTEOTOME, 4MM	41
NT511	OSSEOTITE TAPERED IMPLANT, 5MM(D) X 11.5MM(L)	8	NTOST4A	OSSEOTITE TAPERED ANGLED OSTEOTOME, 4MM	41
NT513	OSSEOTITE TAPERED IMPLANT, 5MM(D) X 13MM(L)	8	NTOST5	OSSEOTITE TAPERED STRAIGHT OSTEOTOME, 5MM	41
NT515	OSSEOTITE TAPERED IMPLANT, 5MM(D) X 15MM(L)	8	NTOST5A	OSSEOTITE TAPERED ANGLED OSTEOTOME, 5MM	41
NT585	OSSEOTITE TAPERED IMPLANT, 5MM(D) X 8.5MM(L)	8	NTOST6	OSSEOTITE TAPERED STRAIGHT OSTEOTOME, 6MM	41
NT610	OSSEOTITE TAPERED IMPLANT, 6MM(D) X 10MM(L)	8	NTOST6A	OSSEOTITE TAPERED ANGLED OSTEOTOME, 6MM	41
NT611	OSSEOTITE TAPERED IMPLANT, 6MM(D) X 11.5MM(L)	8	NTOSTTTRA	OSSEOTITE TAPERED OSTEOTOME TRAY, ANGLED	41
NT613	OSSEOTITE TAPERED IMPLANT, 6MM(D) X 13MM(L)	8	NTOSTTRS	OSSEOTITE TAPERED OSTEOTOME TRAY, STRAIGHT	41
NT615	OSSEOTITE TAPERED IMPLANT, 6MM(D) X 15MM(L)	8	OG1520	OSSEOGUARD® RESORBABLE COLLAGEN MEMBRANE, 15MM X 20MM	47
NT685	OSSEOTITE TAPERED IMPLANT, 6MM(D) X 8.5MM(L)	8	OG2030	OSSEOGUARD RESORBABLE COLLAGEN MEMBRANE, 20MM X 30MM	47
NTAP3210	DENSE BONE TAP FOR TAPERED IMPLANTS, 3.25MM(D) X 10MM(L)	28,37	OG3040	OSSEOGUARD RESORBABLE COLLAGEN MEMBRANE, 30MM X 40MM	47
NTAP3211	DENSE BONE TAP FOR TAPERED IMPLANTS, 3.25MM(D) X 11.5MM(L)	28,37	OGF1520	OSSEOGUARD FLEX® RESORBABLE COLLAGEN MEMBRANE, 15MM X 20MM	47
NTAP3213	DENSE BONE TAP FOR TAPERED IMPLANTS, 3.25MM(D) X 13MM(L)	28,37	OGF2030	OSSEOGUARD FLEX RESORBABLE COLLAGEN MEMBRANE, 20MM X 30MM	47
NTAP3215	DENSE BONE TAP FOR TAPERED IMPLANTS, 3.25MM(D) X 15MM(L)	28,37	OGF3040	OSSEOGUARD FLEX RESORBABLE COLLAGEN MEMBRANE, 30MM X 40MM	47
NTAP3285	DENSE BONE TAP FOR TAPERED IMPLANTS, 3.25MM(D) X 8.5MM(L)	28,37	OSM310	OSSEOTITE PARALLEL WALLED IMPLANT, 3.25MM(D) X 10MM(L)	10
NTAP410	DENSE BONE TAP FOR TAPERED IMPLANTS, 4MM(D) X 10MM(L)	28,37	OSM311	OSSEOTITE PARALLEL WALLED IMPLANT, 3.25MM(D) X 11.5MM(L)	10
NTAP411	DENSE BONE TAP FOR TAPERED IMPLANTS, 4MM(D) X 11.5MM(L)	28,37	OSM313	OSSEOTITE PARALLEL WALLED IMPLANT, 3.25MM(D) X 13MM(L)	10
NTAP413	DENSE BONE TAP FOR TAPERED IMPLANTS, 4MM(D) X 13MM(L)	28,37	OSM315	OSSEOTITE PARALLEL WALLED IMPLANT, 3.25MM(D) X 15MM(L)	10
NTAP415	DENSE BONE TAP FOR TAPERED IMPLANTS, 4MM(D) X 15MM(L)	28,37	OSM318	OSSEOTITE PARALLEL WALLED IMPLANT, 3.25MM(D) X 18MM(L)	10
NTAP485	DENSE BONE TAP FOR TAPERED IMPLANTS, 4MM(D) X 8.5MM(L)	28,37	OSM385	OSSEOTITE PARALLEL WALLED IMPLANT, 3.25MM(D) X 8.5MM(L)	10
NTAP510	DENSE BONE TAP FOR TAPERED IMPLANTS, 5MM(D) X 10MM(L)	28,37	OSS310	OSSEOTITE PARALLEL WALLED IMPLANT, 3.75MM(D) X 6MM(L)	10
NTAP511	DENSE BONE TAP FOR TAPERED IMPLANTS, 5MM(D) X 11.5MM(L)	29,37	OSS311	OSSEOTITE PARALLEL WALLED IMPLANT, 3.75MM(D) X 11.5MM(L)	10
NTAP513	DENSE BONE TAP FOR TAPERED IMPLANTS, 5MM(D) X 13MM(L)	29,37	OSS313	OSSEOTITE PARALLEL WALLED IMPLANT, 3.75MM(D) X 13MM(L)	10
NTAP515	DENSE BONE TAP FOR TAPERED IMPLANTS, 5MM(D) X 15MM(L)	29,37	OSS315	OSSEOTITE PARALLEL WALLED IMPLANT, 3.75MM(D) X 15MM(L)	10
NTAP585	DENSE BONE TAP FOR TAPERED IMPLANTS, 5MM(D) X 8.5MM(L)	28,37	OSS318	OSSEOTITE PARALLEL WALLED IMPLANT, 3.75MM(D) X 18MM(L)	10
NTAP610	DENSE BONE TAP FOR TAPERED IMPLANTS, 6MM(D) X 10MM(L)	29,37	OSS320	OSSEOTITE PARALLEL WALLED IMPLANT, 3.75MM(D) X 20MM(L)	10
NTAP611	DENSE BONE TAP FOR TAPERED IMPLANTS, 6MM(D) X 11.5MM(L)	29,37	OSS385	OSSEOTITE PARALLEL WALLED IMPLANT, 3.75MM(D) X 8.5MM(L)	10
NTAP613	DENSE BONE TAP FOR TAPERED IMPLANTS, 6MM(D) X 13MM(L)	29,37	OSS410	OSSEOTITE PARALLEL WALLED IMPLANT, 4MM(D) X 6MM(L)	10
NTAP615	DENSE BONE TAP FOR TAPERED IMPLANTS, 6MM(D) X 15MM(L)	29,37	OSS411	OSSEOTITE PARALLEL WALLED IMPLANT, 4MM(D) X 11.5MM(L)	10
NTAP685	DENSE BONE TAP FOR TAPERED IMPLANTS, 6MM(D) X 8.5MM(L)	29,37	OSS413	OSSEOTITE PARALLEL WALLED IMPLANT, 4MM(D) X 13MM(L)	10
NTAPK	DENSE BONE TAP KIT	37	OSS415	OSSEOTITE PARALLEL WALLED IMPLANT, 4MM(D) X 15MM(L)	10

Index

Item#	Description	Page#	Item#	Description	Page#
OSS418	OSSEOTITE® PARALLEL WALLED IMPLANT, 4MM(D) X 18MM(L)	10	QSD513	QUAD SHAPING DRILL, 5MM(D) X 13MM(L)	28,35
OSS420	OSSEOTITE PARALLEL WALLED IMPLANT, 4MM(D) X 20MM(L)	10	QSD515	QUAD SHAPING DRILL, 5MM(D) X 15MM(L)	28,35
OSS485	OSSEOTITE PARALLEL WALLED IMPLANT, 4MM(D) X 8.5MM(L)	10	QSD585	QUAD SHAPING DRILL, 5MM(D) X 8.5MM(L)	28,35
OSS507	OSSEOTITE PARALLEL WALLED IMPLANT, 5MM(D) X 7MM(L)	10	QSD610	QUAD SHAPING DRILL, 6MM(D) X 10MM(L)	28,35
OSS510	OSSEOTITE PARALLEL WALLED IMPLANT, 5MM(D) X 10MM(L)	10	QSD611	QUAD SHAPING DRILL, 6MM(D) X 11.5MM(L)	28,35
OSS511	OSSEOTITE PARALLEL WALLED IMPLANT, 5MM(D) X 11.5MM(L)	10	QSD613	QUAD SHAPING DRILL, 6MM(D) X 13MM(L)	28,35
OSS513	OSSEOTITE PARALLEL WALLED IMPLANT, 5MM(D) X 13MM(L)	10	QSD615	QUAD SHAPING DRILL, 6MM(D) X 15MM(L)	28,35
OSS515	OSSEOTITE PARALLEL WALLED IMPLANT, 5MM(D) X 15MM(L)	10	QSD685	QUAD SHAPING DRILL, 6MM(D) X 8.5MM(L)	28,35
OSS518	OSSEOTITE PARALLEL WALLED IMPLANT, 5MM(D) X 18MM(L)	10	RASH3N	NARROW RIGHT ANGLE LARGE HEXED DRIVER TIP, 24MM(L)	22,26,30,32,34
OSS585	OSSEOTITE PARALLEL WALLED IMPLANT, 5MM(D) X 8.5MM(L)	10	RDCA205	CANCELLOUS, PARTIALLY DEMINERALIZED, 0.5CC, 200-300µm	45
OSS607	OSSEOTITE PARALLEL WALLED IMPLANT, 6MM(D) X 7MM(L)	10	RDCA210	CANCELLOUS, PARTIALLY DEMINERALIZED, 1CC, 200-300µm	45
OSS610	OSSEOTITE PARALLEL WALLED IMPLANT, 6MM(D) X 10MM(L)	10	RDCA220	CANCELLOUS, PARTIALLY DEMINERALIZED, 2CC, 200-300µm	45
OSS611	OSSEOTITE PARALLEL WALLED IMPLANT, 6MM(D) X 11.5MM(L)	10	RDCA305	CANCELLOUS, PARTIALLY DEMINERALIZED, 0.5CC, 300-500µm	45
OSS613	OSSEOTITE PARALLEL WALLED IMPLANT, 6MM(D) X 13MM(L)	10	RDCA305R	CANCELLOUS, PARTIALLY DEMINERALIZED, IRRADIATED, 0.5CC, 300-500µm	46
OSS615	OSSEOTITE PARALLEL WALLED IMPLANT, 6MM(D) X 15MM(L)	10	RDCA310	CANCELLOUS, PARTIALLY DEMINERALIZED, 1CC, 300-500µm	45
OSS618	OSSEOTITE PARALLEL WALLED IMPLANT, 6MM(D) X 18MM(L)	10	RDCA310R	CANCELLOUS, PARTIALLY DEMINERALIZED, IRRADIATED, 1CC, 300-500µm	46
OSS685	OSSEOTITE PARALLEL WALLED IMPLANT, 6MM(D) X 8.5MM(L)	10	RDCA320	CANCELLOUS, PARTIALLY DEMINERALIZED, 2CC, 300-500µm	45
OST00	SUMMERS OSTEOTOME KIT #1-4	41	RDCA320R	CANCELLOUS, PARTIALLY DEMINERALIZED, IRRADIATED, 2CC, 300-500µm	46
OST01	SUMMERS OSTEOTOME #1	41	RDCA505	CANCELLOUS, PARTIALLY DEMINERALIZED, 0.5CC, 500-800µm	45
OST02	SUMMERS OSTEOTOME #2	41	RDCA510	CANCELLOUS, PARTIALLY DEMINERALIZED, 1CC, 500-800µm	45
OST03	SUMMERS OSTEOTOME #3	41	RDCA520	CANCELLOUS, PARTIALLY DEMINERALIZED, 2CC, 500-800µm	45
OST04	SUMMERS OSTEOTOME #4	41	RDCO205	CORTICAL, PARTIALLY DEMINERALIZED, 0.5CC, 200-300µm	45
OST05	SUMMERS OSTEOTOME #5	41	RDCO205R	CORTICAL, PARTIALLY DEMINERALIZED, IRRADIATED, 0.5CC, 200-300µm	46
OST10	SUMMERS OSTEOTOME KIT #1-5	41	RDCO210	CORTICAL, PARTIALLY DEMINERALIZED, 1CC, 200-300µm	45
OST20	SUMMERS OSTEOTOME KIT #1-5 AND FUTURE SITE	41	RDCO220	CORTICAL, PARTIALLY DEMINERALIZED, 2CC, 200-300µm	45
OSTFS	SUMMERS OSTEOTOME FOR FUTURE SITE	41	RDCO305	CORTICAL, PARTIALLY DEMINERALIZED, 0.5CC, 300-500µm	45
OSTTR	SUMMERS OSTEOTOME SYSTEM TRAY	41	RDCO305R	CORTICAL, PARTIALLY DEMINERALIZED, IRRADIATED, 0.5CC, 300-500µm	46
PD100	PILOT REUSABLE DRILL, 2-3MM	32,33,35	RDCO310	CORTICAL, PARTIALLY DEMINERALIZED, 1CC, 300-500µm	45
PEMODLOC	PATIENT ED MODEL - LOCATOR®	48	RDCO310R	CORTICAL, PARTIALLY DEMINERALIZED, IRRADIATED, 1CC, 300-500µm	46
PEMODSM	PATIENT ED MODEL - SINGLE/MULTIPLE TEETH	48	RDCO320	CORTICAL, PARTIALLY DEMINERALIZED, 2CC, 300-500µm	45
PHD00N	NARROW POSTERIOR SMALL HEX DRIVER, 17MM	30,32,34	RDCO320R	CORTICAL, PARTIALLY DEMINERALIZED, IRRADIATED, 2CC, 300-500µm	46
PHD02N	NARROW POSTERIOR LARGE HEX DRIVER, 17MM	22,26,30,32,34	RDCO505	CORTICAL, PARTIALLY DEMINERALIZED, 0.5CC, 500-800µm	45
PSKT01	STARTER KIT	31,32	RDCO510	CORTICAL, PARTIALLY DEMINERALIZED, 1CC, 500-800µm	45
PSKT10	BASIC SURGICAL KIT - PLASTIC	33,34	RDCO520	CORTICAL, PARTIALLY DEMINERALIZED, 2CC, 500-800µm	45
PSKT20	STANDARD UNISYSTEM SURGICAL KIT - PLASTIC	33,34	RD100	STAINLESS STEEL ROUND DRILL, 2MM(D)	32,34,35
PSKT30	PREMIUM UNISYSTEM SURGICAL KIT	33,34	RE100	RATCHET EXTENSION - SHORT, 6MM(L)	22,26,29,32,34,39
PSKT35	CERTAIN® PREMIUM SURGICAL KIT	31,32	RE200	RATCHET EXTENSION - LONG, 15MM(L)	22,26,29,32,34,39
PSKT40	CERTAIN PREMIUM SURGICAL KIT FOR PARALLEL WALLED IMPLANT	31,32	RMB30	RADIOGRAPHIC MARKING BALLS (30-PACK)	40
PTT100	PLASTIC TRAY ORGANIZER	31,33,34	RMCA205	CANCELLOUS, MINERALIZED, 0.5CC, 200-300µm	45
PTT300I	PLASTIC SURGICAL TRAY ORGANIZER	31,33	RMCA205R	CANCELLOUS, MINERALIZED, IRRADIATED, 0.5CC, 200-300µm	46
QBM001	R. QUÉTIN BONE MILL	47	RMCA210	CANCELLOUS, MINERALIZED, 1CC, 200-300µm	45
QNTSK20	TAPERED IMPLANT STARTER (BASIC) KIT	28,29,30	RMCA220	CANCELLOUS, MINERALIZED, 2CC, 200-300µm	45
QNTSK40	TAPERED IMPLANT QUAD SHAPING DRILL, PREMIUM SURGICAL KIT	28,29,30	RMCA305	CANCELLOUS, MINERALIZED, 0.5CC, 300-500µm	45
QNTSK40U	TAPERED IMPLANT QUAD SHAPING DRILL, PREMIUM UPGRADE KIT	28,29,30	RMCA305R	CANCELLOUS, MINERALIZED, IRRADIATED, 0.5CC, 300-500µm	46
QNTSKT	QSD/NTDI SURGICAL TRAY	29	RMCA310	CANCELLOUS, MINERALIZED, 1CC, 300-500µm	45
QSD3210	QUAD SHAPING DRILL, 3.25MM(D) X 10MM(L)	28,35	RMCA310R	CANCELLOUS, MINERALIZED, IRRADIATED, 1CC, 300-500µm	46
QSD3211	QUAD SHAPING DRILL, 3.25MM(D) X 11.5MM(L)	28,35	RMCA320	CANCELLOUS, MINERALIZED, 2CC, 300-500µm	45
QSD3213	QUAD SHAPING DRILL, 3.25MM(D) X 13MM(L)	28,35	RMCA505	CANCELLOUS, MINERALIZED, 0.5CC, 500-800µm	45
QSD3215	QUAD SHAPING DRILL, 3.25MM(D) X 15MM(L)	28,35	RMCA510	CANCELLOUS, MINERALIZED, 1CC, 500-800µm	45
QSD3285	QUAD SHAPING DRILL, 3.25MM(D) X 8.5MM(L)	28,35	RMCA520	CANCELLOUS, MINERALIZED, 2CC, 500-800µm	45
QSD410	QUAD SHAPING DRILL, 4MM(D) X 10MM(L)	28,35	RMCO205	CORTICAL, MINERALIZED, 0.5CC, 200-300µm	45
QSD411	QUAD SHAPING DRILL, 4MM(D) X 11.5MM(L)	28,35	RMCO210	CORTICAL, MINERALIZED, 1CC, 200-300µm	45
QSD413	QUAD SHAPING DRILL, 4MM(D) X 13MM(L)	28,35	RMCO220	CORTICAL, MINERALIZED, 2CC, 200-300µm	45
QSD415	QUAD SHAPING DRILL, 4MM(D) X 15MM(L)	28,35	RMCO305	CORTICAL, MINERALIZED, 0.5CC, 300-500µm	45
QSD485	QUAD SHAPING DRILL, 4MM(D) X 8.5MM(L)	28,35	RMCO305R	CORTICAL, MINERALIZED, IRRADIATED, 0.5CC, 300-500µm	46
QSD510	QUAD SHAPING DRILL, 5MM(D) X 10MM(L)	28,35	RMCO310	CORTICAL, MINERALIZED, 1CC, 300-500µm	45
QSD511	QUAD SHAPING DRILL, 5MM(D) X 11.5MM(L)	28,35	RMCO310R	CORTICAL, MINERALIZED, IRRADIATED, 1CC, 300-500µm	46

Index

Item#	Description	Page#	Item#	Description	Page#
RMC0320	CORTICAL, MINERALIZED, 2CC, 300-500µm	45	SGDPH2	NAVIGATOR DRILL POSITIONING HANDLE 2	26
RMC0505	CORTICAL, MINERALIZED, 0.5CC, 500-800µm	45	SGDPH3	NAVIGATOR DRILL POSITIONING HANDLE 3	26
RMC0510	CORTICAL, MINERALIZED, 1CC, 500-800µm	45	SGDPH4	NAVIGATOR DRILL POSITIONING HANDLE 4	26
RMC0520	CORTICAL, MINERALIZED, 2CC, 500-800µm	45	SGDPH5	NAVIGATOR DRILL POSITIONING HANDLE 5	26
ROAP05	REGENEROSS® ALLOGRAFT PUTTY, 0.5CC SYRINGE	46	SGIAM4L	NAVIGATOR CERTAIN® ANALOG MOUNT, 4.1MM(D) - LONG	24
ROAP10	REGENEROSS ALLOGRAFT PUTTY, 1CC SYRINGE	46	SGIAM4S	NAVIGATOR CERTAIN ANALOG MOUNT, 4.1MM(D) - SHORT	24
ROAP20	REGENEROSS ALLOGRAFT PUTTY, 2CC SYRINGE	46	SGIAM5L	NAVIGATOR CERTAIN ANALOG MOUNT, 5MM(D) - LONG	24
ROAPM05	REGENEROSS ALLOGRAFT PUTTY PLUS, 0.5CC SYRINGE	46	SGIAM5S	NAVIGATOR CERTAIN ANALOG MOUNT, 5MM(D) - SHORT	24
ROAPM10	REGENEROSS ALLOGRAFT PUTTY PLUS, 1CC SYRINGE	46	SGIAM41	NAVIGATOR CERTAIN ANALOG MOUNT, 4.1MM(D) X 1(L)	27
ROAPM20	REGENEROSS ALLOGRAFT PUTTY PLUS, 2CC (4 X 0.5CC SYRINGES)	46	SGIAM42	NAVIGATOR CERTAIN ANALOG MOUNT, 4.1MM(D) X 2(L)	27
ROX05	ENDOBON® XENOGRAFT GRANULES, 0.5ML PACK	47	SGIAM43	NAVIGATOR CERTAIN ANALOG MOUNT, 4.1MM(D) X 3(L)	27
ROX10	ENDOBON XENOGRAFT GRANULES, 1ML PACK	47	SGIAM44	NAVIGATOR CERTAIN ANALOG MOUNT, 4.1MM(D) X 4(L)	27
ROX20	ENDOBON XENOGRAFT GRANULES, 2ML PACK	47	SGIAM51	NAVIGATOR CERTAIN ANALOG MOUNT, 5MM(D) X 1(L)	27
ROXLG20	ENDOBON XENOGRAFT GRANULES, 1000-2000µm, 2ML	47	SGIAM52	NAVIGATOR CERTAIN ANALOG MOUNT, 5MM(D) X 2(L)	27
ROXLG50	ENDOBON XENOGRAFT GRANULES, 1000-2000µm, 5ML	47	SGIAM53	NAVIGATOR CERTAIN ANALOG MOUNT, 5MM(D) X 3(L)	27
ROXLG80	ENDOBON XENOGRAFT GRANULES, 1000-2000µm, 8ML	47	SGIAM54	NAVIGATOR CERTAIN ANALOG MOUNT, 5MM(D) X 4(L)	27
SEKT1	SINUS ELEVATION KIT	42	SGIIM4L	NAVIGATOR CERTAIN IMPLANT MOUNT, 4.1MM(D) - LONG	22
SEKTR	SINUS ELEVATION TRAY	42	SGIIM4S	NAVIGATOR CERTAIN IMPLANT MOUNT, 4.1MM(D) - SHORT	22
SGD275A	NAVIGATOR® TWIST DRILL, 2.75MM(D) X A(L)	25	SGIIM5L	NAVIGATOR CERTAIN IMPLANT MOUNT, 5MM(D) - LONG	22
SGD275B	NAVIGATOR TWIST DRILL, 2.75MM(D) X B(L)	25	SGIIM5S	NAVIGATOR CERTAIN IMPLANT MOUNT, 5MM(D) - SHORT	22
SGD275C	NAVIGATOR TWIST DRILL, 2.75MM(D) X C(L)	25	SGIIM41	NAVIGATOR CERTAIN IMPLANT MOUNT, 4.1MM(D) X 1(L)	26
SGD275D	NAVIGATOR TWIST DRILL, 2.75MM(D) X D(L)	25	SGIIM42	NAVIGATOR CERTAIN IMPLANT MOUNT, 4.1MM(D) X 2(L)	26
SGD275E	NAVIGATOR TWIST DRILL, 2.75MM(D) X E(L)	25	SGIIM43	NAVIGATOR CERTAIN IMPLANT MOUNT, 4.1MM(D) X 3(L)	26
SGD275Y	NAVIGATOR TWIST DRILL, 2.75MM(D) X Y(L)	26	SGIIM44	NAVIGATOR CERTAIN IMPLANT MOUNT, 4.1MM(D) X 4(L)	26
SGD275Z	NAVIGATOR TWIST DRILL, 2.75MM(D) X Z(L)	26	SGIIM51	NAVIGATOR CERTAIN IMPLANT MOUNT, 5MM(D) X 1(L)	26
SGD2A	NAVIGATOR TWIST DRILL, 2MM(D) X A(L)	25	SGIIM52	NAVIGATOR CERTAIN IMPLANT MOUNT, 5MM(D) X 2(L)	26
SGD2B	NAVIGATOR TWIST DRILL, 2MM(D) X B(L)	25	SGIIM53	NAVIGATOR CERTAIN IMPLANT MOUNT, 5MM(D) X 3(L)	26
SGD2C	NAVIGATOR TWIST DRILL, 2MM(D) X C(L)	25	SGIIM54	NAVIGATOR CERTAIN IMPLANT MOUNT, 5MM(D) X 4(L)	26
SGD2D	NAVIGATOR TWIST DRILL, 2MM(D) X D(L)	25	SGISD5	NAVIGATOR CERTAIN STARTER DRILL, 5MM(D)	25
SGD2Y	NAVIGATOR TWIST DRILL, 2MM(D) X Y(L)	26	SGKIT	NAVIGATOR SURGICAL KIT	25,26
SGD2Z	NAVIGATOR TWIST DRILL, 2MM(D) X Z(L)	26	SGLKIT	NAVIGATOR LABORATORY KIT	27
SGD325A	NAVIGATOR TWIST DRILL, 3.25MM(D) X A(L)	25	SGLTRAY	NAVIGATOR LABORATORY TRAY	27
SGD325B	NAVIGATOR TWIST DRILL, 3.25MM(D) X B(L)	25	SGQ-ER20H	OSSEOCISION® 20:1 HANDPIECE	20
SGD325C	NAVIGATOR TWIST DRILL, 3.25MM(D) X C(L)	25	SGSD34	NAVIGATOR STARTER DRILL, 3/4MM(D)	25
SGD325D	NAVIGATOR TWIST DRILL, 3.25MM(D) X D(L)	25	SGSD4	NAVIGATOR STARTER DRILL, 4.1MM(D)	25
SGD325E	NAVIGATOR TWIST DRILL, 3.25MM(D) X E(L)	25	SGSD45	NAVIGATOR STARTER DRILL, 4/5MM(D)	25
SGD325Y	NAVIGATOR TWIST DRILL, 3.25MM(D) X Y(L)	26	SGT25	STENT GUIDE TUBE (25-PACK)	40
SGD325Z	NAVIGATOR TWIST DRILL, 3.25MM(D) X Z(L)	26	SGTAP4	NAVIGATOR BONE TAP, 4.1MM(D)	26
SGD385A	NAVIGATOR TWIST DRILL, 3.85MM(D) X A(L)	25	SGTAP45	NAVIGATOR BONE TAP, 4/5MM(D)	26
SGD385B	NAVIGATOR TWIST DRILL, 3.85MM(D) X B(L)	25	SGTAP5	NAVIGATOR BONE TAP, 5MM(D)	26
SGD385C	NAVIGATOR TWIST DRILL, 3.85MM(D) X C(L)	25	SGTCD4L	TAPERED NAVIGATOR COUNTERSINK DRILL, 4.1MM(D) - LONG	21
SGD385Y	NAVIGATOR TWIST DRILL, 3.85MM(D) X Y(L)	26	SGTCD4S	TAPERED NAVIGATOR COUNTERSINK DRILL, 4.1MM(D) - SHORT	21
SGD385Z	NAVIGATOR TWIST DRILL, 3.85MM(D) X Z(L)	26	SGTCD5L	TAPERED NAVIGATOR COUNTERSINK DRILL, 5MM(D) - LONG	21
SGD3A	NAVIGATOR TWIST DRILL, 3MM(D) X A(L)	25	SGTCD5S	TAPERED NAVIGATOR COUNTERSINK DRILL, 5MM(D) - SHORT	21
SGD3B	NAVIGATOR TWIST DRILL, 3MM(D) X B(L)	25	SGTCP4L	TAPERED NAVIGATOR CORTICAL PERFORATOR, 4.1MM(D) - LONG	21
SGD3C	NAVIGATOR TWIST DRILL, 3MM(D) X C(L)	25	SGTCP4S	TAPERED NAVIGATOR CORTICAL PERFORATOR, 4.1MM(D) - SHORT	21
SGD3D	NAVIGATOR TWIST DRILL, 3MM(D) X D(L)	25	SGTCP5L	TAPERED NAVIGATOR CORTICAL PERFORATOR, 5MM(D) - LONG	21
SGD3E	NAVIGATOR TWIST DRILL, 3MM(D) X E(L)	25	SGTCP5S	TAPERED NAVIGATOR CORTICAL PERFORATOR, 5MM(D) - SHORT	21
SGD3Y	NAVIGATOR TWIST DRILL, 3MM(D) X Y(L)	26	SGTD19A	TAPERED NAVIGATOR TWIST DRILL, 1.9MM(D) X A(L)	21
SGD3Z	NAVIGATOR TWIST DRILL, 3MM(D) X Z(L)	26	SGTD19B	TAPERED NAVIGATOR TWIST DRILL, 1.9MM(D) X B(L)	21
SGD425A	NAVIGATOR TWIST DRILL, 4.25MM(D) X A(L)	25	SGTD19C	TAPERED NAVIGATOR TWIST DRILL, 1.9MM(D) X C(L)	21
SGD425B	NAVIGATOR TWIST DRILL, 4.25MM(D) X B(L)	26	SGTD19D	TAPERED NAVIGATOR TWIST DRILL, 1.9MM(D) X D(L)	21
SGD425C	NAVIGATOR TWIST DRILL, 4.25MM(D) X C(L)	26	SGTD19E	TAPERED NAVIGATOR TWIST DRILL, 1.9MM(D) X E(L)	21
SGD425Y	NAVIGATOR TWIST DRILL, 4.25MM(D) X Y(L)	26	SGTD19F	TAPERED NAVIGATOR TWIST DRILL, 1.9MM(D) X F(L)	21
SGD425Z	NAVIGATOR TWIST DRILL, 4.25MM(D) X Z(L)	26	SGTD19G	TAPERED NAVIGATOR TWIST DRILL, 1.9MM(D) X G(L)	21
SGD2E	NAVIGATOR TWIST DRILL, 2MM(D) X E(L)	25	SGTD410L	TAPERED NAVIGATOR SHAPING DRILL, 4.1MM(D) X 10MM(L) - LONG	22
SGDPH1	NAVIGATOR DRILL POSITIONING HANDLE 1	26	SGTD410S	TAPERED NAVIGATOR SHAPING DRILL, 4.1MM(D) X 10MM(L) - SHORT	21

Index

Item#	Description	Page#		Page#	
SGTD411L	TAPERED NAVIGATOR® SHAPING DRILL, 4.1MM(D) X 11.5MM(L) - LONG	22	TAP53S	BONE TAP, 5MM(D) X 7-13MM(L)	32,33,37
SGTD411S	TAPERED NAVIGATOR SHAPING DRILL, 4.1MM(D) X 11.5MM(L) - SHORT	21	TAP58S	BONE TAP, 5MM(D) X 7-8.5MM(L)	37
SGTD413L	TAPERED NAVIGATOR SHAPING DRILL, 4.1MM(D) X 13MM(L) - LONG	22	TAP618S	BONE TAP, 6MM(D) X 7-18MM(L)	37
SGTD413S	TAPERED NAVIGATOR SHAPING DRILL, 4.1MM(D) X 13MM(L) - SHORT	21	TAP63S	BONE TAP, 6MM(D) X 7-13MM(L)	32,33,37
SGTD415L	TAPERED NAVIGATOR SHAPING DRILL, 4.1MM(D) X 15MM(L) - LONG	22	TAP68S	BONE TAP, 6MM(D) X 7-8.5MM(L)	37
SGTD415S	TAPERED NAVIGATOR SHAPING DRILL, 4.1MM(D) X 15MM(L) - SHORT	21	TE003	TITANIUM ELEVATOR	39
SGTD485L	TAPERED NAVIGATOR SHAPING DRILL, 4.1MM(D) X 8.5MM(L) - LONG	22	TF002	TITANIUM FORCEPS	39
SGTD485S	TAPERED NAVIGATOR SHAPING DRILL, 4.1MM(D) X 8.5MM(L) - SHORT	21	THA42	EP® 1-PIECE HEALING ABUTMENT, 4.1MM(D) X 4.1MM(P) X 2MM(H)	16
SGTD510L	TAPERED NAVIGATOR SHAPING DRILL, 5MM(D) X 10MM(L) - LONG	22	THA43	EP 1-PIECE HEALING ABUTMENT, 4.1MM(D) X 4.1MM(P) X 3MM(H)	16
SGTD510S	TAPERED NAVIGATOR SHAPING DRILL, 5MM(D) X 10MM(L) - SHORT	22	THA44	EP 1-PIECE HEALING ABUTMENT, 4.1MM(D) X 4.1MM(P) X 4MM(H)	16
SGTD511L	TAPERED NAVIGATOR SHAPING DRILL, 5MM(D) X 11.5MM(L) - LONG	22	THA46	EP 1-PIECE HEALING ABUTMENT, 4.1MM(D) X 4.1MM(P) X 6MM(H)	16
SGTD511S	TAPERED NAVIGATOR SHAPING DRILL, 5MM(D) X 11.5MM(L) - SHORT	22	THA48	EP 1-PIECE HEALING ABUTMENT, 4.1MM(D) X 4.1MM(P) X 8MM(H)	16
SGTD513L	TAPERED NAVIGATOR SHAPING DRILL, 5MM(D) X 13MM(L) - LONG	22	THA52	EP 1-PIECE HEALING ABUTMENT, 4.1MM(D) X 5MM(P) X 2MM(H)	16
SGTD513S	TAPERED NAVIGATOR SHAPING DRILL, 5MM(D) X 13MM(L) - SHORT	22	THA53	EP 1-PIECE HEALING ABUTMENT, 4.1MM(D) X 5MM(P) X 3MM(H)	16
SGTD515L	TAPERED NAVIGATOR SHAPING DRILL, 5MM(D) X 15MM(L) - LONG	22	THA54	EP 1-PIECE HEALING ABUTMENT, 4.1MM(D) X 5MM(P) X 4MM(H)	16
SGTD515S	TAPERED NAVIGATOR SHAPING DRILL, 5MM(D) X 15MM(L) - SHORT	22	THA56	EP 1-PIECE HEALING ABUTMENT, 4.1MM(D) X 5MM(P) X 6MM(H)	16
SGTD585L	TAPERED NAVIGATOR SHAPING DRILL, 5MM(D) X 8.5MM(L) - LONG	22	THA58	EP 1-PIECE HEALING ABUTMENT, 4.1MM(D) X 5MM(P) X 8MM(H)	16
SGTD585S	TAPERED NAVIGATOR SHAPING DRILL, 5MM(D) X 8.5MM(L) - SHORT	21	THA63	EP 1-PIECE HEALING ABUTMENT, 4.1MM(D) X 6MM(P) X 3MM(H)	16
SGTDPHR	TAPERED NAVIGATOR REDUCTION DRILL POSITIONING HANDLE	22	THA64	EP 1-PIECE HEALING ABUTMENT, 4.1MM(D) X 6MM(P) X 4MM(H)	16
SGTDPHT	TAPERED NAVIGATOR TWIST DRILL POSITIONING HANDLE	22	THA66	EP 1-PIECE HEALING ABUTMENT, 4.1MM(D) X 6MM(P) X 6MM(H)	16
SGTLTRAY	TAPERED NAVIGATOR LABORATORY TRAY	24	THA68	EP 1-PIECE HEALING ABUTMENT, 4.1MM(D) X 6MM(P) X 8MM(H)	16
SGTP4	NAVIGATOR TISSUE PUNCH, 4.1MM(D)	25	THRC4	TEMPORARY HEALING RETENTION CYLINDER, 4.1MM(D) X 4MM(H)	16
SGTP5	NAVIGATOR TISSUE PUNCH, 5MM(D)	25	THRC6	TEMPORARY HEALING RETENTION CYLINDER, 4.1MM(D) X 6MM(H)	16
SGTRAY	NAVIGATOR SURGICAL TRAY	25	TIBC1	TITANIUM NITRIDE COATED BONE CARRIER FOR SEKT1	42
SGTT410L	TAPERED NAVIGATOR BONE TAP, 4.1MM(D) X 10(L) - LONG	23	TIPL1	LARGE TITANIUM PLUGGER	42
SGTT410S	TAPERED NAVIGATOR BONE TAP, 4.1MM(D) X 10(L) - SHORT	23	TIPS1	SMALL TITANIUM PLUGGER	42
SGTT411L	TAPERED NAVIGATOR BONE TAP, 4.1MM(D) X 11.5(L) - LONG	23	TMP80	TISSUE MEASURING POST	39
SGTT411S	TAPERED NAVIGATOR BONE TAP, 4.1MM(D) X 11.5(L) - SHORT	23	TP001	TISSUE PUNCH, 4.1MM(D)	40
SGTT413L	TAPERED NAVIGATOR BONE TAP, 4.1MM(D) X 13(L) - LONG	23	TP005	TISSUE PUNCH, 5MM(D)	40
SGTT413S	TAPERED NAVIGATOR BONE TAP, 4.1MM(D) X 13(L) - SHORT	23	TP006	TISSUE PUNCH, 6MM(D)	40
SGTT415L	TAPERED NAVIGATOR BONE TAP, 4.1MM(D) X 15(L) - LONG	23	TRE02	TREPHINE BUR - 2MM INSIDE DIAMETER/3MM OUTSIDE DIAMETER	42
SGTT415S	TAPERED NAVIGATOR BONE TAP, 4.1MM(D) X 15(L) - SHORT	23	TRE04	TREPHINE BUR - 4MM INSIDE DIAMETER/5MM OUTSIDE DIAMETER	42
SGTT485L	TAPERED NAVIGATOR BONE TAP, 4.1MM(D) X 8.5(L) - LONG	23	TRE05	TREPHINE BUR - 5MM INSIDE DIAMETER/6MM OUTSIDE DIAMETER	42
SGTT485S	TAPERED NAVIGATOR BONE TAP, 4.1MM(D) X 8.5(L) - SHORT	23	TRE06	TREPHINE BUR - 6MM INSIDE DIAMETER/7MM OUTSIDE DIAMETER	42
SGTT510L	TAPERED NAVIGATOR BONE TAP, 5MM(D) X 10(L) - LONG	23	TRE08	TREPHINE BUR - 8MM INSIDE DIAMETER/9.3MM OUTSIDE DIAMETER	42
SGTT510S	TAPERED NAVIGATOR BONE TAP, 5MM(D) X 10(L) - SHORT	23	TST01	TITANIUM SUCTION TIP	39
SGTT511L	TAPERED NAVIGATOR BONE TAP, 5MM(D) X 11.5(L) - LONG	23	U198-013	OSSEOCISION® ELECTRICAL POWER CORD, 230V (AUSTRALIA)	20
SGTT511S	TAPERED NAVIGATOR BONE TAP, 5MM(D) X 11.5(L) - SHORT	23	U260-414	OSSEOCISION ELECTRICAL POWER CORD, 230V (EUROPE)	20
SGTT513L	TAPERED NAVIGATOR BONE TAP, 5MM(D) X 13(L) - LONG	23	U195-152	OSSEOCISION FUSES (100V/120V)	20
SGTT513S	TAPERED NAVIGATOR BONE TAP, 5MM(D) X 13(L) - SHORT	23	U197-152	OSSEOCISION FUSES (230V)	20
SGTT515L	TAPERED NAVIGATOR BONE TAP, 5MM(D) X 15(L) - LONG	23	U370-152	OSSEOCISION COOLANT SOLUTION HANGER POST	20
SGTT515S	TAPERED NAVIGATOR BONE TAP, 5MM(D) X 15(L) - SHORT	23	U370-003	OSSEOCISION CONTROL UNIT, 100V	20
SGTT585L	TAPERED NAVIGATOR BONE TAP, 5MM(D) X 8.5(L) - LONG	23	U371-003	OSSEOCISION CONTROL UNIT, 120V	20
SGTT585S	TAPERED NAVIGATOR BONE TAP, 5MM(D) X 8.5(L) - SHORT	23	U372-003	OSSEOCISION CONTROL UNIT, 230V	20
SGTTAPT	TAPERED NAVIGATOR BONE TAP TRAY	23	U389-013	OSSEOCISION ELECTRICAL POWER CORD, 100V	20
SGTTP4	TAPERED NAVIGATOR TISSUE PUNCH, 4.1MM(D)	21	WR150	RATCHET WRENCH	22,26,29,32,34
SGTTP5	TAPERED NAVIGATOR TISSUE PUNCH, 5MM(D)	21	WTH52	EP 1-PIECE HEALING ABUTMENT, 5MM(D) X 5MM(P) X 2MM(H)	16
SGTTRAY	TAPERED NAVIGATOR SURGICAL TRAY	21	WTH53	EP 1-PIECE HEALING ABUTMENT, 5MM(D) X 5MM(P) X 3MM(H)	16
SLIMKT	SURGICAL SLIM KIT FOR TAPERED CERTAIN® IMPLANTS	28,29,30	WTH54	EP 1-PIECE HEALING ABUTMENT, 5MM(D) X 5MM(P) X 4MM(H)	16
SLIMKTE	SURGICAL SLIM KIT FOR CERTAIN & EXTERNAL HEX IMPLANTS	28,29,30	WTH56	EP 1-PIECE HEALING ABUTMENT, 5MM(D) X 5MM(P) X 6MM(H)	16
TAP10	BONE TAP, 3.75MM(D) X 7-10MM(L)	37	WTH562	EP 1-PIECE HEALING ABUTMENT, 5MM(D) X 6MM(P) X 2MM(H)	16
TAP13	BONE TAP, 3.75MM(D) X 7-13MM(L)	37	WTH563	EP 1-PIECE HEALING ABUTMENT, 5MM(D) X 6MM(P) X 3MM(H)	16
TAP20	BONE TAP, 3.75MM(D) X 7-20MM(L)	37	WTH564	EP 1-PIECE HEALING ABUTMENT, 5MM(D) X 6MM(P) X 4MM(H)	16
TAP410	BONE TAP, 4MM(D) X 7-10MM(L)	37	WTH566	EP 1-PIECE HEALING ABUTMENT, 5MM(D) X 6MM(P) X 6MM(H)	16
TAP413	BONE TAP, 4MM(D) X 7-13MM(L)	32,33,37	WTH568	EP 1-PIECE HEALING ABUTMENT, 5MM(D) X 6MM(P) X 8MM(H)	16
TAP420	BONE TAP, 4MM(D) X 7-20MM(L)	37	WTH58	EP 1-PIECE HEALING ABUTMENT, 5MM(D) X 5MM(P) X 8MM(H)	16
TAP518S	BONE TAP, 5MM(D) X 7-18MM(L)	37	WTH62	EP 1-PIECE HEALING ABUTMENT, 6MM(D) X 6MM(P) X 2MM(H)	16

Index

Item#	Description	Page#	Item#	Description	Page#
WTH63	EP® 1-PIECE HEALING ABUTMENT, 6MM(D) X 6MM(P) X 3MM(H)	16	XIFOSS511	OSSEOTITE 2 PARALLEL WALLED CERTAIN IMPLANT, 5MM(D) X 11.5MM(L)	6
WTH64	EP 1-PIECE HEALING ABUTMENT, 6MM(D) X 6MM(P) X 4MM(H)	16	XIFOSS513	OSSEOTITE 2 PARALLEL WALLED CERTAIN IMPLANT, 5MM(D) X 13MM(L)	6
WTH66	EP 1-PIECE HEALING ABUTMENT, 6MM(D) X 6MM(P) X 6MM(H)	16	XIFOSS515	OSSEOTITE 2 PARALLEL WALLED CERTAIN IMPLANT, 5MM(D) X 15MM(L)	6
WTH68	EP 1-PIECE HEALING ABUTMENT, 6MM(D) X 6MM(P) X 8MM(H)	16	XIFOSS585	OSSEOTITE 2 PARALLEL WALLED CERTAIN IMPLANT, 5MM(D) X 8.5MM(L)	6
XDG00	GELB X-RAY DEPTH GAUGE KIT	40	XIFOSS610	OSSEOTITE 2 PARALLEL WALLED CERTAIN IMPLANT, 6MM(D) X 10MM(L)	6
XDG01	GELB X-RAY DEPTH GAUGE KIT, 2.3MM(D)	40	XIFOSS611	OSSEOTITE 2 PARALLEL WALLED CERTAIN IMPLANT, 6MM(D) X 11.5MM(L)	6
XDG13	GELB X-RAY DEPTH GAUGE, 2MM(D) X 13MM(L)	40	XIFOSS613	OSSEOTITE 2 PARALLEL WALLED CERTAIN IMPLANT, 6MM(D) X 13MM(L)	6
XDG20	GELB X-RAY DEPTH GAUGE, 2MM(D) X 20MM(L)	40	XIFOSS615	OSSEOTITE 2 PARALLEL WALLED CERTAIN IMPLANT, 6MM(D) X 15MM(L)	6
XDG2313	GELB X-RAY DEPTH GAUGE, 2.3MM(D) X 13MM(L)	40	XIFOSS685	OSSEOTITE 2 PARALLEL WALLED CERTAIN IMPLANT, 6MM(D) X 8.5MM(L)	6
XDG2320	GELB X-RAY DEPTH GAUGE, 2.3MM(D) X 20MM(L)	40	XIIOS4310	OSSEOTITE 2 CERTAIN PREVAIL® IMPLANT, 4MM(D) X 3.4MM(P) X 10MM(L)	4
XFOS310	OSSEOTITE® 2 PARALLEL WALLED IMPLANT, 3.75MM(D) X 10MM(L)	9	XIIOS4311	OSSEOTITE 2 CERTAIN PREVAIL IMPLANT, 4MM(D) X 3.4MM(P) X 11.5MM(L)	4
XFOS311	OSSEOTITE 2 PARALLEL WALLED IMPLANT, 3.75MM(D) X 11.5MM(L)	9	XIIOS4313	OSSEOTITE 2 CERTAIN PREVAIL IMPLANT, 4MM(D) X 3.4MM(P) X 13MM(L)	4
XFOS313	OSSEOTITE 2 PARALLEL WALLED IMPLANT, 3.75MM(D) X 13MM(L)	9	XIIOS4315	OSSEOTITE 2 CERTAIN PREVAIL IMPLANT, 4MM(D) X 3.4MM(P) X 15MM(L)	4
XFOS315	OSSEOTITE 2 PARALLEL WALLED IMPLANT, 3.75MM(D) X 15MM(L)	9	XIIOS4385	OSSEOTITE 2 CERTAIN PREVAIL IMPLANT, 4MM(D) X 3.4MM(P) X 8.5MM(L)	4
XFOS365	OSSEOTITE 2 PARALLEL WALLED IMPLANT, 3.75MM(D) X 6.5MM(L)	9	XIIOS5410	OSSEOTITE 2 CERTAIN PREVAIL IMPLANT, 5MM(D) X 4.1MM(P) X 10MM(L)	4
XFOS385	OSSEOTITE 2 PARALLEL WALLED IMPLANT, 3.75MM(D) X 8.5MM(L)	9	XIIOS5411	OSSEOTITE 2 CERTAIN PREVAIL IMPLANT, 5MM(D) X 4.1MM(P) X 11.5MM(L)	4
XFOS410	OSSEOTITE 2 PARALLEL WALLED IMPLANT, 4MM(D) X 10MM(L)	9	XIIOS5413	OSSEOTITE 2 CERTAIN PREVAIL IMPLANT, 5MM(D) X 4.1MM(P) X 13MM(L)	4
XFOS411	OSSEOTITE 2 PARALLEL WALLED IMPLANT, 4MM(D) X 11.5MM(L)	9	XIIOS5415	OSSEOTITE 2 CERTAIN PREVAIL IMPLANT, 5MM(D) X 4.1MM(P) X 15MM(L)	4
XFOS413	OSSEOTITE 2 PARALLEL WALLED IMPLANT, 4MM(D) X 13MM(L)	9	XIIOS5485	OSSEOTITE 2 CERTAIN PREVAIL IMPLANT, 5MM(D) X 4.1MM(P) X 8.5MM(L)	4
XFOS415	OSSEOTITE 2 PARALLEL WALLED IMPLANT, 4MM(D) X 15MM(L)	9	XIIOS6510	OSSEOTITE 2 CERTAIN PREVAIL IMPLANT, 6MM(D) X 5MM(P) X 10MM(L)	4
XFOS465	OSSEOTITE 2 PARALLEL WALLED IMPLANT, 4MM(D) X 6.5MM(L)	9	XIIOS6511	OSSEOTITE 2 CERTAIN PREVAIL IMPLANT, 6MM(D) X 5MM(P) X 11.5MM(L)	4
XFOS485	OSSEOTITE 2 PARALLEL WALLED IMPLANT, 4MM(D) X 8.5MM(L)	9	XIIOS6513	OSSEOTITE 2 CERTAIN PREVAIL IMPLANT, 6MM(D) X 5MM(P) X 13MM(L)	4
XFOS510	OSSEOTITE 2 PARALLEL WALLED IMPLANT, 5MM(D) X 10MM(L)	9	XIIOS6515	OSSEOTITE 2 CERTAIN PREVAIL IMPLANT, 6MM(D) X 5MM(P) X 15MM(L)	4
XFOS511	OSSEOTITE 2 PARALLEL WALLED IMPLANT, 5MM(D) X 11.5MM(L)	9	XIIOS6585	OSSEOTITE 2 CERTAIN PREVAIL IMPLANT, 6MM(D) X 5MM(P) X 8.5MM(L)	4
XFOS513	OSSEOTITE 2 PARALLEL WALLED IMPLANT, 5MM(D) X 13MM(L)	9	XTAP518S	OSSEOTITE 2 DENSE BONE TAP 5MM(D) X 7-18MM(L)	37
XFOS515	OSSEOTITE 2 PARALLEL WALLED IMPLANT, 5MM(D) X 15MM(L)	9	XTAP53S	OSSEOTITE 2 DENSE BONE TAP 5MM(D) X 7-13MM(L)	32,33,37
XFOS565	OSSEOTITE 2 PARALLEL WALLED IMPLANT, 5MM(D) X 6.5MM(L)	9	XTAP58S	OSSEOTITE 2 DENSE BONE TAP 5MM(D) X 7-8.5MM(L)	37
XFOS585	OSSEOTITE 2 PARALLEL WALLED IMPLANT, 5MM(D) X 8.5MM(L)	9	XTAP618S	OSSEOTITE 2 DENSE BONE TAP 6MM(D) X 7-18MM(L)	37
XFOS610	OSSEOTITE 2 PARALLEL WALLED IMPLANT, 6MM(D) X 10MM(L)	9	XTAP63S	OSSEOTITE 2 DENSE BONE TAP 6MM(D) X 7-13MM(L)	32,33,37
XFOS611	OSSEOTITE 2 PARALLEL WALLED IMPLANT, 6MM(D) X 11.5MM(L)	9	XTAP68S	OSSEOTITE 2 DENSE BONE TAP 6MM(D) X 7-8.5MM(L)	37
XFOS613	OSSEOTITE 2 PARALLEL WALLED IMPLANT, 6MM(D) X 13MM(L)	9	Y900-083	OSSEOCISION® IRRIGATION TUBE HOLDER	20
XFOS615	OSSEOTITE 2 PARALLEL WALLED IMPLANT, 6MM(D) X 15MM(L)	9	Y900-114	OSSEOCISION IRRIGATION TUBES, DISPOSABLE (10-PACK)	20
XFOS665	OSSEOTITE 2 PARALLEL WALLED IMPLANT, 6MM(D) X 6.5MM(L)	9	Z095-102	OSSEOCISION MOTOR CRADLE	20
XFOS685	OSSEOTITE 2 PARALLEL WALLED IMPLANT, 6MM(D) X 8.5MM(L)	9	Z103-101	OSSEOCISION HANDPIECE WRENCH	20
XFOSM310	OSSEOTITE 2 PARALLEL WALLED IMPLANT, 3.25MM(D) X 10MM(L)	9	Z114-090	OSSEOCISION SPRAY LUBRICANT NOZZLE	20
XFOSM311	OSSEOTITE 2 PARALLEL WALLED IMPLANT, 3.25MM(D) X 11.5MM(L)	9	Z144-095	OSSEOCISION NOZZLE CLEANING FINE WIRE	20
XFOSM313	OSSEOTITE 2 PARALLEL WALLED IMPLANT, 3.25MM(D) X 13MM(L)	9	Z272-004	OSSEOCISION FOOT CONTROL (3.5M)	20
XFOSM315	OSSEOTITE 2 PARALLEL WALLED IMPLANT, 3.25MM(D) X 15MM(L)	9			
XFOSM365	OSSEOTITE 2 PARALLEL WALLED IMPLANT, 3.25MM(D) X 6.5MM(L)	9			
XFOSM385	OSSEOTITE 2 PARALLEL WALLED IMPLANT, 3.25MM(D) X 8.5MM(L)	9			
XIFOSM310	OSSEOTITE 2 PARALLEL WALLED CERTAIN® IMPLANT, 3.25MM(D) X 10MM(L)	6			
XIFOSM311	OSSEOTITE 2 PARALLEL WALLED CERTAIN IMPLANT, 3.25MM(D) X 11.5MM(L)	6			
XIFOSM313	OSSEOTITE 2 PARALLEL WALLED CERTAIN IMPLANT, 3.25MM(D) X 13MM(L)	6			
XIFOSM315	OSSEOTITE 2 PARALLEL WALLED CERTAIN IMPLANT, 3.25MM(D) X 15MM(L)	6			
XIFOSM385	OSSEOTITE 2 PARALLEL WALLED CERTAIN IMPLANT, 3.25MM(D) X 8.5MM(L)	6			
XIFOSS410	OSSEOTITE 2 PARALLEL WALLED CERTAIN IMPLANT, 4MM(D) X 10MM(L)	6			
XIFOSS411	OSSEOTITE 2 PARALLEL WALLED CERTAIN IMPLANT, 4MM(D) X 11.5MM(L)	6			
XIFOSS413	OSSEOTITE 2 PARALLEL WALLED CERTAIN IMPLANT, 4MM(D) X 13MM(L)	6			
XIFOSS415	OSSEOTITE 2 PARALLEL WALLED CERTAIN IMPLANT, 4MM(D) X 15MM(L)	6			
XIFOSS485	OSSEOTITE 2 PARALLEL WALLED CERTAIN IMPLANT, 4MM(D) X 8.5MM(L)	6			
XIFOSS510	OSSEOTITE 2 PARALLEL WALLED CERTAIN IMPLANT, 5MM(D) X 10MM(L)	6			

**Some products may not be available outside the U.S.A.
Algunos productos no se comercializan fuera de EE.UU.
Certains produits ne sont pas disponibles en dehors des États-Unis.
Einige Produkte sind außerhalb der USA nicht erhältlich.**

To Place an Order:

Contact your local BIOMET **3i** Representative or call:

BIOMET **3i** Customer Service
Monday–Thursday 8am–8pm (EST)
Friday 8am–6:30pm (EST)
800-342-5454, Fax 561-776-1272
In Canada: 800-363-1980, Outside US: 561-776-6700

TERMS AND CONDITIONS OF SALE. The following are the terms and conditions by which BIOMET **3i** sells its products.

GOVERNING TERMS. Any shipment of products shall be deemed to be on the terms and conditions stated herein. Any and all terms and conditions submitted by Purchaser are hereby rejected.

TAXES. The prices set forth herein do not include any sales, use, excise, ad valorem, property or other taxes applicable to the sale, use or delivery of the products, all of which shall be paid by Purchaser separately or added to the contract price and paid by Purchaser to BIOMET **3i**.

PRICES. The prices set forth for the products are in United States Dollars.

DELIVERY. Products sold hereunder shall be delivered by BIOMET **3i**, F.O.B. Palm Beach Gardens, Florida.

PAYMENT. Payment terms shall be as set forth under the Terms section on front of the invoice.

WARRANTY. BIOMET **3i** nor any of its affiliates make any warranty, express or implied, except that its products shall be free from defects in material and/or workmanship. This warranty applies only to the original Purchaser. In the event of a product defect, immediately notify BIOMET **3i** of the defect prior to returning the product. Devices shall be sterilized prior to return. As its sole obligation and as Purchaser's sole remedy under this warranty, BIOMET **3i** will, at its option, either repair, replace or issue credit for such products. Purchaser assumes all risks and liability resulting from the use of these products, whether used separately or in combination with other products.

Except for the warranty expressly described in the warranty paragraph above, neither BIOMET **3i** nor any of its affiliates makes any other warranty with respect to the BIOMET **3i** Products, expressed or implied, written or oral, including, without limitation, any implied warranty of merchantability, or a warranty of fitness for a particular purpose.

EDUCATION; MODIFICATION OF PRODUCTS. BIOMET **3i** reserves the right to modify products, discontinue products and change specifications of products.

RETURN POLICY. A Purchaser may return any BIOMET **3i** Product within 90 days of the invoice date. BIOMET **3i** Products returned within 60 days of the invoice date will be accepted without any re-stocking fee to the Purchaser. BIOMET **3i** Products returned between 61 and 90 days of the invoice date will be subject to a 15% restocking fee. A BIOMET **3i** Product will be accepted for return only if the BIOMET **3i** Product is (1) returned in its original, unopened package (including autoclavable products); (2) received by BIOMET **3i** within 90 days after the invoice date for that product; and (3) returned freight prepaid to 4555 Riverside Drive, Palm Beach Gardens, Florida 33410, (Attention: Returns Department) accompanied by the BIOMET **3i** Return Authorization Number provided by the BIOMET **3i** Customer Service Department. Purchaser should be advised that BIOMET **3i** Products not meeting the above criteria will not be accepted for return.

EXCHANGE POLICY. BIOMET **3i** Products may be exchanged within 180 days of the invoice date, without a re-stocking fee, for other BIOMET **3i** Products of equal or lesser value within the same product family as determined by BIOMET **3i** (ex. implant for implant, abutment for abutment, membrane for membrane). BIOMET **3i** Products may be exchanged within 180 days of the invoice date for other BIOMET **3i** Products of greater value within the same product family as determined by BIOMET **3i** (ex. implant for implant, abutment for abutment, membrane for membrane), with the price differential paid by the Purchaser. In both cases, the exchanged BIOMET **3i** Product must be (1) returned in its original, unopened package (including autoclavable products); (2) a currently offered BIOMET **3i** Product (discontinued product not included); and (3) returned freight prepaid to 4555 Riverside Drive, Palm Beach Gardens, Florida 33410, (Attention: Returns Department) and accompanied by the BIOMET **3i** Products Return Authorization Number provided by the BIOMET **3i** Customer Service Department.

AVAILABILITY OF PRODUCTS. All products are not available in all areas. Any offer or product void where prohibited by law.

EXPORT CONTROL. All products are subject to all applicable export control and sanctions legislation.

FORCE MAJEURE. BIOMET **3i** shall not be liable for any loss or damage due to failure or delay arising out of any cause beyond the reasonable control of BIOMET **3i**. In the event of any failure or delay resulting from such causes, an equitable adjustment of delivery and any other appropriate terms and conditions shall be made. No such failure or delay shall be the basis for an increase of obligation by BIOMET **3i** nor any termination by the Purchaser.

LIMITATION OF LIABILITY. Under no circumstances shall BIOMET **3i** nor any of its affiliates be liable for business interruption, loss of profits, special, indirect, incidental or consequential damages of any nature and from any cause whether based in contract, warranty or tort (including negligence) or other legal theory, even if BIOMET **3i** has been advised of the possibility of such damages.

VALIDITY. If any provision of these Terms and Conditions is found to be illegal or unenforceable in any respect, such illegality or unenforceability shall not affect any other provision of these Terms and Conditions, all of which shall remain enforceable in accordance with their terms.

GENERAL PROVISIONS. The purchase of the products and these Terms and Conditions are governed by the laws of Florida without regard to conflicts of law principles. This document incorporates all oral and written representations between the parties and constitutes the entire agreement and understanding of the parties with respect to the subject matter hereof and supercedes any and all other agreements either oral or written between the parties with respect to such subject matter. No amendment or modification may be made to this document unless made in writing and duly executed by an authorized representative of BIOMET **3i**.

CAUTION. Federal (U.S.) Law restricts these devices to sale by or on the order of a licensed healthcare practitioner. Devices labeled STERILE are certified to be sterile unless sterile package is opened or damaged.

EXPORT ORDERS. Require advance payment or letter of credit. Shipments are made either by freight collect or paid by BIOMET **3i** and added to the invoice. Unless special instructions are received with an order, the shipping method will be determined by BIOMET **3i**, F.O.B. Palm Beach Gardens, Florida.

DUNS #: 186127825
BIOMET **3i** is listed in the SAM (U.S. System for Award Management) Database.
©2014 BIOMET **3i** LLC.

Want More? Solutions Start Here

VISIT
www.biomet3i.com

For More Information, Please Contact Your Local BIOMET 3i Sales Representative



BIOMET 3i
4555 Riverside Drive
Palm Beach Gardens, FL 33410
1-800-342-5454
Outside The U.S.: +1-561-776-6700
Fax: +1-561-776-1272
www.biomet3i.com

EC REP **BIOMET 3i**
Dental Iberica S.L.
WTC Almeda Park, Ed. 1, Planta 1ª
Pl. de la Pau, s/n
08940, Cornellà de Llobregat
(Barcelona) Spain
Phone: +34-93-470-55-00
Fax: +34-93-371-78-49



Join Us



Follow Us



Watch Us



Download It

3i T3, ACT, Advanced Cutting Technology, BellaTek, BellaTek design, Biogran, Bone Bonding, Certain, DCD, DIEM, Encode, Endobon, EP, GingiHue, Gold-Tite, Navigator, OSSEOCISION, OsseoGuard, OsseoGuard Flex, OSSEOTITE, OSSEOTITE XP, PreFormance, PREVAİL, Provide, QuickSeat, RegenerOss and ZiReal are registered trademarks of BIOMET 3i LLC. **3i** T3 design, ICE, NanoTite, Providing Solutions – One Patient At A Time and Twist Lock are trademarks of BIOMET 3i LLC. ©2014 BIOMET 3i LLC.

Dolder is a registered trademark of Prof. Eugen Dolder, formerly the director of the School of Dentistry at the University of Zurich. Endobon is a registered trademark of BIOMET Deutschland GmbH. LOCATOR is a registered trademark of Zest Anchors, Inc. Safescraper is a registered trademark of CGM S.p.A. Divisione Medica META.

All trademarks herein are the property of BIOMET 3i LLC unless otherwise indicated. This material is intended for clinicians only and is NOT intended for patient distribution. This material is not to be redistributed, duplicated, or disclosed without the express written consent of BIOMET 3i. For additional product information, including indications, contraindications, warnings, precautions, and potential adverse effects, see the product package insert and the BIOMET 3i Website.



CATSUR
REV H 01/14